



# japanese english



OVER 6,000 WORDS  
AND PHRASES

B I L I N G U A L  
D I C T I O N A R Y

[www.ebook3000.com](http://www.ebook3000.com)

JAPANESE  
ENGLISH







**BILINGUAL**  
**VISUAL**  
DICTIONARY



**BILINGUAL**  
**VISUAL**  
**DICTIONARY**





London, New York, Melbourne, Munich, Delhi

Senior Editor Angela Wilkes  
Project Art Editor Katie Eke  
Production Editor Luca Frassinetti  
Production Controller Linda Dare  
Managing Art Editor Lee Griffiths  
Managing Editor Stephanie Farrow  
US Editor Jill Hamilton

Designed for Dorling Kindersley by WaltonCreative.com

Art Editor Colin Walton, assisted by Tracy Musson  
Designers Peter Radcliffe, Earl Neish, Ann Cannings  
Picture Research Marissa Keating

Language content for Dorling Kindersley by  
g-and-w PUBLISHING

Managed by Jane Wightwick  
Translation by Kazumi Honda  
Layout by Mark Wightwick  
Editing by Cheryl Hutty

First American Edition, 2011

Published in the United States by DK Publishing,  
375 Hudson Street, New York, New York 10014

11 12 13 14 15 10 9 8 7 6 5 4 3 2 1  
001—179043—May/2011

Copyright © 2011 Dorling Kindersley Limited  
All rights reserved.

Without limiting the rights under copyright reserved above,  
no part of this publication may be reproduced, stored  
in or introduced into a retrieval system, or transmitted  
in any form, or by any means (electronic, mechanical,  
photocopying, recording, or otherwise) without the prior  
written permission of both the copyright owner and the  
above publisher of this book.

Published in Great Britain by Dorling Kindersley Limited.

A catalog record for this book is available from  
the Library of Congress.

ISBN 978-0-7566-7556-1

DK books are available at special discounts when purchased in bulk  
for sales promotions, premiums, fund-raising, or educational use. For  
details, contact: DK Publishing Special Markets, 375 Hudson Street,  
New York, New York 10014 or SpecialSales@dk.com

Printed and bound in China by L. Rex Printing Co. Ltd.

Discover more at  
[www.dk.com](http://www.dk.com)

## 目次 mokuji contents

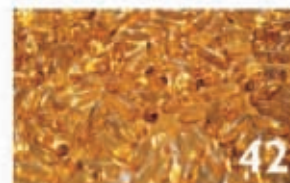

42

健康  
kenkō  
health



146

外食  
gaishoku  
eating out



252

娛樂  
goraku  
leisure



6  
この辞典について  
kono jiten nitsuite  
about the dictionary



8  
この辞典の使い方  
kono jiten no tsukaikata  
how to use this book



10  
人  
hito  
people



28  
外観  
gaikan  
appearance



56  
家庭  
katei  
home



92  
職務  
shokumu  
services



102  
買い物  
kaimono  
shopping



116  
食べ物  
tabemono  
food



160  
学習  
gakushū  
study



170  
仕事  
shigoto  
work



192  
交通  
kōtsū  
transportation



218  
スポーツ  
supōtsu  
sports



278  
環境  
kankyō  
environment



302  
参考資料  
sankō shiryō  
reference



324  
索引  
sakuin  
index



360  
謝辞  
shaji  
acknowledgments



## 人 hito • people

|                                       |    |
|---------------------------------------|----|
| 身体 karada   body                      | 12 |
| 顔 kao   face                          | 14 |
| 手 te   hand                           | 15 |
| 足 ashi   foot                         | 15 |
| 筋肉 kinniku   muscles                  | 16 |
| 骨格 kokkaku   skeleton                 | 17 |
| 内蔵 naizō<br>internal organs           | 18 |
| 生殖器 seishokuki<br>reproductive organs | 20 |
| 家族 kazoku   family                    | 22 |
| 人間関係 ningen kankei<br>relationships   | 24 |
| 感情 kanjō   emotions                   | 25 |
| 人生 jinsei   life events               | 26 |

外観 gaikan  
• appearance

|  |    |
|--|----|
| 子供服 kodomo fuku<br>children's clothing | 30 |
| 男性服 dansei fuku<br>men's clothing      | 32 |
| 女性服 josei fuku<br>women's clothing     | 34 |
| 装身具 sōshingu   accessories             | 36 |
| 髪 kami   hair                          | 38 |
| 美容 biyō   beauty                       | 40 |

## 健康 kenkō • health

|  |    |
|--|----|
| 病気 byōki   illness                       | 44 |
| 医者 isha   doctor                         | 45 |
| 怪我 kega   injury                         | 46 |
| 応急手当 ōkyū teate   first aid              | 47 |
| 病院 byōin   hospital                      | 48 |
| 歯医者 haisha   dentist                     | 50 |
| 眼鏡店 megane-ten   optician                | 51 |
| 妊娠 ninshin   pregnancy                   | 52 |
| 出産 shussan   childbirth                  | 53 |
| 代替療法 daitai ryōhō<br>alternative therapy | 54 |

## 家庭 katei • home

|  |    |
|--|----|
| 住宅 jūtaku   house                            | 58 |
| 住宅内設備 jūtaku-nai setsubi<br>internal systems | 60 |
| 居間 ima   living room                         | 62 |
| ダイニングルーム dainingu rūmu<br>dining room        | 64 |
| 台所 daidokoro   kitchen                       | 66 |
| 調理用具 chōri yōgu<br>kitchenware               | 68 |
| 寝室 shinshitsu   bedroom                      | 70 |
| 浴室 yokushitsu   bathroom                     | 72 |
| 子供部屋 kodomobeya   nursery                    | 74 |
| ユティリティルーム yutiriti rūmu<br>utility room      | 76 |
| 作業場 sagyōba   workshop                       | 78 |
| 道具箱 dōgubako<br>toolbox                      | 80 |
| 内装工事 naisō kōji   decorating                 | 82 |
| 庭 niwa   garden                              | 84 |
| 庭の植物 niwa no shokubutsu<br>garden plants     | 86 |
| 園芸用品 engei yōhin<br>garden tools             | 88 |
| 園芸 engei   gardening                         | 90 |

## 職務 shokumu

|  |     |
|--|-----|
| • services                                 |     |
| 緊急サービス kinkyū sābisu<br>emergency services | 94  |
| 銀行 ginkō   bank                            | 96  |
| コミュニケーション komyunikēshon<br>communications  | 98  |
| ホテル hoteru   hotel                         | 100 |

## 買い物 kaimono

|   |     |
|---|-----|
| • shopping                                      |     |
| ショッピングセンター<br>shoppingu sentā   shopping centre | 104 |
| デパート depāto<br>department store                 | 105 |

|                                      |     |
|--------------------------------------|-----|
| スーパーマーケット sūpāmāketto<br>supermarket | 106 |
| 薬局 yakkyoku   chemist                | 108 |
| 花屋 hanaya   florist                  | 110 |
| 新聞販売店 shimbun hambaiten<br>newsagent | 112 |
| 菓子屋 kashiya<br>confectioner          | 113 |
| その他の店 sonota no mise<br>other shops  | 114 |

食べ物 tabemono  
• food

|   |     |
|---|-----|
| 肉 niku   meat                                   | 118 |
| 魚 sakana   fish                                 | 120 |
| 野菜 yasai   vegetables                           | 122 |
| 果物 kudamono   fruit                             | 126 |
| 穀類と豆類 kokurui to mamerui<br>grains and legumes  | 130 |
| ハーブと香辛料 hābu to<br>kōshinryō   herbs and spices | 132 |
| 瓶詰め食品 binzume shokuhin<br>bottled foods         | 134 |
| 乳製品 nyūseihin<br>dairy produce                  | 136 |
| パンと小麦粉 pan to komugiko<br>breads and flours     | 138 |
| ケーキとデザート kēki to dezāto<br>cakes and desserts   | 140 |
| デリカテッセン derikatessen<br>delicatessen            | 142 |
| 飲物 nomimono   drinks                            | 144 |

## 外食 gaishoku

|                                   |     |
|-----------------------------------|-----|
| • eating out                      |     |
| カフェ kafe   café                   | 148 |
| バー bā   bar                       | 150 |
| レストラン resutoran   restaurant      | 152 |
| ファーストフード fāsuto fūdo<br>fast food | 154 |
| 朝食 chōshoku   breakfast           | 156 |
| 食事 shokuji   dinner               | 158 |

**学習 gakushū • study**

|                       |     |
|-----------------------|-----|
| 学校 gakkō   school     | 162 |
| 数学 sūgaku   math      | 164 |
| 科学 kagaku   science   | 166 |
| 大学 daigaku<br>college | 168 |

**仕事 shigoto • work**

|                             |     |
|-----------------------------|-----|
| 事務所 jimusho   office        | 172 |
| コンピュータ kompyūta<br>computer | 176 |
| 報道 hōdō   media             | 178 |
| 法律 hōritsu   law            | 180 |
| 農場 nōjō   farm              | 182 |
| 建設 kensetsu   construction  | 186 |
| 職業 shokugyō   occupations   | 188 |

**交通 kōtsū  
• transportation**

|                            |     |
|----------------------------|-----|
| 道路 dōro   roads            | 194 |
| バス basu   bus              | 196 |
| 自動車 jidōsha   car          | 198 |
| オートバイ ōtobai<br>motorcycle | 204 |
| 自転車 jitensha   bicycle     | 206 |
| 列車 ressha   train          | 208 |
| 航空機 kōkūki   aircraft      | 210 |
| 空港 kūkō   airport          | 212 |
| 船 fune   ship              | 214 |
| 港湾 kōwan   port            | 216 |

**スポーツ supōtsu  
• sports**

|  |     |
|--|-----|
| アメリカンフットボール<br>amerikan futtobōru<br>American football | 220 |
| ラグビー ragubī   rugby                                    | 221 |
| サッカー sakkā   soccer                                    | 222 |
| ホッケー hokkē   hockey                                    | 224 |
| クリケット kuriketto   cricket                              | 225 |

|                                      |     |
|--------------------------------------|-----|
| バスケットボール basukettobōru<br>basketball | 226 |
| 野球 yakyū   baseball                  | 228 |
| テニス tenisu   tennis                  | 230 |
| ゴルフ gorufu   golf                    | 232 |
| 陸上競技 rikujō kyōgi<br>track and field | 234 |
| 格闘技 kakutōgi<br>combat sports        | 236 |
| 水泳 suiei   swimming                  | 238 |
| セーリング sēringu   sailing              | 240 |
| 乗馬 jōba   horseback riding           | 242 |
| 釣り tsuri   fishing                   | 244 |
| スキー sukī   skiing                    | 246 |
| 他のスポーツ ta no supōtsu<br>other sports | 248 |
| フィットネス fittonesu   fitness           | 250 |

**娯楽 goraku • leisure**

|   |     |
|---|-----|
| 劇場 gekijō   theater                       | 254 |
| オーケストラ ōkesutora<br>orchestra             | 256 |
| コンサート konsāto   concert                   | 258 |
| 観光 kankō   sightseeing                    | 260 |
| 野外活動 yagai katsudō<br>outdoor activities  | 262 |
| 海辺 umibe   beach                          | 264 |
| キャンプ kyampu   camping                     | 266 |
| 娯楽家電 goraku kaden<br>home entertainment   | 268 |
| 写真 shashin<br>photography                 | 270 |
| ゲーム gēmu   games                          | 272 |
| 美術と工芸 bijutsu to kōgei<br>arts and crafts | 274 |

**環境 kankyō  
• environment**

|                        |     |
|------------------------|-----|
| 宇宙空間 uchūkūkan   space | 280 |
| 地球 chikyū   Earth      | 282 |
| 地勢 chisei   landscape  | 284 |
| 気象 kishō   weather     | 286 |



|                            |     |
|----------------------------|-----|
| 岩石 ganseki   rocks         | 288 |
| 鉱石 kōseki   minerals       | 289 |
| 動物 dōbutsu   animals       | 290 |
| 植物 shokubutsu   plants     | 296 |
| 市街 shigai   town           | 298 |
| 建築 kenchiku   architecture | 300 |

**参考資料 sankō shiryō  
• reference**

|   |     |
|---|-----|
| 時間 jikan   time   | 304 |
| カレンダー karendā   calendar                                      | 306 |
| 数字 sūji   numbers   | 308 |
| 計量 keiryō<br>weights and measures                             | 310 |
| 世界地図 sekai chizu<br>world map                                 | 312 |
| 不変化詞と反義語 fuhenkashi to<br>hangigo<br>  particles and antonyms | 320 |
| 便利な表現 benri na hyōgen<br>useful phrases                       | 322 |

## この辞典について

情報の理解と記憶に視覚的資料が効果的なことは、既に実証されています。その原理に従って図版を主体に作成された本和英ビジュアル辞典は、広範な分野の実用的現代用語を収録しています。

内容はテーマ別に分けられ、レストラン、ジム、家庭や職場から、動物界や宇宙に至るまで、日常社会のほとんどの分野が詳細に網羅されています。さらに会話と語彙の拡大に役立てられるよう、関連用語や便利な言い回しも付け加えられています。

実用的で使いやすく、見ておもしろい本辞典は、日本語に関心のある方に欠かせない参考資料です。

### 表記法について

本辞典には、日本で一般に使われている漢字仮名まじり表記が使用されています。魚の名前など、漢字でも仮名でも表記できる言葉は、発音ガイドとして載せたローマ字から仮名の綴りが分かるため、漢字の方を使うようにしました。

発音ガイドには、日本語の学習者なら大抵知っているローマ字が使われています。ローマ字の表記法にはいくつかありますが、本書ではもっとも発音しやすいと思われる方法を選びました。なお、長音は母音の上に長音記号をつけて表記しています。

単語はすべて、次のように漢字・仮名、ローマ字、英語の順で掲載されています。

|          |          |
|----------|----------|
| 昼食       | 旅券       |
| chūshoku | ryoken   |
| lunch    | passport |

動詞は英語の後に (v) をつけて示しています。

収穫する shūkaku suru | harvest (v)

辞典の後ろには和英別の索引があり、ローマ字または英語で引きたい言葉を調べ、該当する図が載っているページを探することができます。漢字・仮名の書き方を調べる場合は、先ずローマ字または英語の索引を調べ、該当するページをご覧ください。

## about the dictionary

The use of pictures is proven to aid understanding and the retention of information. Working on this principle, this highly illustrated English–Japanese bilingual dictionary presents a large range of useful current vocabulary.

The dictionary is divided thematically and covers most aspects of the everyday world in detail, from the restaurant to the gym, the home to the workplace, outer space to the animal kingdom. You will also find additional words and phrases for conversational use and for extending your vocabulary.

This is an essential reference tool for anyone interested in languages—practical, stimulating, and easy-to-use.

### A few things to note

The three different writing systems of the Japanese script (*Kanji*, *Katakana*, and *Hiragana*) are employed in the dictionary following common usage. However, where alternative usages exist for individual items of vocabulary (for example animals), we have usually chosen to use Kanji since the pronunciation that follows will indicate the Katakana or Hiragana spellings.

The pronunciation included for the Japanese is shown in *Romaji*, the romanization system that is familiar to most learners of Japanese (see Pronunciation tips).

The entries are always presented in the same order—Japanese, Romaji, English:

|          |          |
|----------|----------|
| 昼食       | 旅券       |
| chūshoku | ryoken   |
| lunch    | passport |

Verbs are indicated by a (v) after the English, for example:

収穫する shūkaku suru | harvest (v)

Each language also has its own index at the back of the book. Here you can look up a word in either English or Romaji and be referred to the page number(s) where it appears. To reference the Japanese characters, look up a word either in the Romaji or English index and then go to the page indicated.



### Pronunciation tips

The pronunciation in the dictionary is shown in the Romaji system. There are some variations possible in Romaji, but we have tried to use the most user-friendly transcription.

Many of the letters used in Romaji can be pronounced as they would be in English, but some require special explanation:

- r Never rolled; pronounced with the tip of the tongue against the gum of the upper front teeth
- f Pronounced more with the lips and less with the teeth than its English equivalent
- w A semi-vowel pronounced with slack lips
- ts As in "pits"
- ei As in "pay" or "rein"
- n/m The Japanese characters ん and ン are generally pronounced "n" as in **さん** san, but this changes to "m" before the sounds "b" or "p," e.g. コンピュータ kompyūta.

Japanese vowels are pronounced short similar to the English "pat/pet/pit/pot/put". However, they can also be lengthened. This is shown in the Japanese script by a dash (一) and in the Romaji by a macron (flat line) over the vowel (ū). Lengthened vowels should have the sound sustained for approximately twice the amount of time.

In general, Japanese words do not have a particular stress, or emphasis. Each syllable is stressed roughly equally. Take care also to pronounce the syllables separately; there are no "silent" letters. For example, カフェ kafe is pronounced "ka-fay" rather than "kayf."



# この辞典の使い方

仕事や趣味、海外旅行の準備で初めて日本語を習う方でも、あるいは既に日本語を知っていて語彙を伸ばしたい方でも、本書は大切な学習ツールとして様々な方法で使うことができます。

初心者の方は、同語源語（外来語など異なる言語で語源が共通する言葉）や派生語（同一言語で語源が共通する言葉）に注目すると語彙の習得に便利です。また、こうした学習によって、異なる言語が互いに影響しあっていることも分かってくるでしょう。たとえば日本語には英語圏から流入した食物関連の言葉が多くありますが、一方、日本から英語圏へ流出した技術や大衆文化に関する言葉も多くあります。

## 実用的な学習方法

- 自宅、職場、学校や大学の構内を歩いているとき、辞典の該当するページを見てください。そして辞典を閉じ、周りを見回して、名前をいえるものがいくつあるか見てみましょう。
- 単語カードを作り、表に英語、裏に漢字や仮名、ローマ字で日本語を書きましょう。単語カードは常に持ち歩き、頻繁に自分でテストしてみましょう。一回テストが終わったら、次のテストの前にカードを入れ替えましょう。
- 特定のページに載っている単語をできるだけたくさん使い、短い物語、手紙、会話文などを書いてみましょう。これは語彙を記憶し、書き方を覚えるのに役立ちます。長い文章を書いてみたい場合は、一つの文に単語を2〜3語使ってみましょう。
- 視覚的記憶に強い方は、紙に図を描くか写し、辞典を閉じて、図の下に単語を書いてみましょう。
- 自信がついてきたら、ローマ字索引から単語を選択し、該当ページの図を見る前に、その意味を覚えているかどうかチェックしましょう。

# how to use this book

Whether you are learning a new language for business, pleasure, or in preparation for a vacation abroad, or are hoping to extend your vocabulary in an already familiar language, this dictionary is a valuable learning tool that you can use in a number of different ways.

When learning a new language, look out for cognates (words that are alike in different languages) and derivations (words that share a common root in a particular language). You can also see where the languages have influenced each other. For example, English has imported some terms for food from Japanese but, in turn, has exported many terms used in technology and popular culture.

## Practical learning activities

- As you move around your home, workplace, or college, try looking at the pages which cover that setting. You could then close the book, look around you and see how many of the objects and features you can name.
- Make flashcards for yourself with English on one side and Japanese/Romaji on the other side. Carry the cards with you and test yourself frequently, making sure you shuffle them between each test.
- Challenge yourself to write a story, letter, or dialogue using as many of the terms on a particular page as possible. This will help you retain the vocabulary and remember the spelling. If you want to build up to writing a longer text, start with sentences incorporating 2-3 words.
- If you have a very visual memory, try drawing or tracing items from the book onto a piece of paper, then close the book and fill in the words below the picture.
- Once you are more confident, pick out words in the foreign language index and see if you know what they mean before turning to the relevant page to check if you were right.









人 hito  
people

# 身体 karada • body

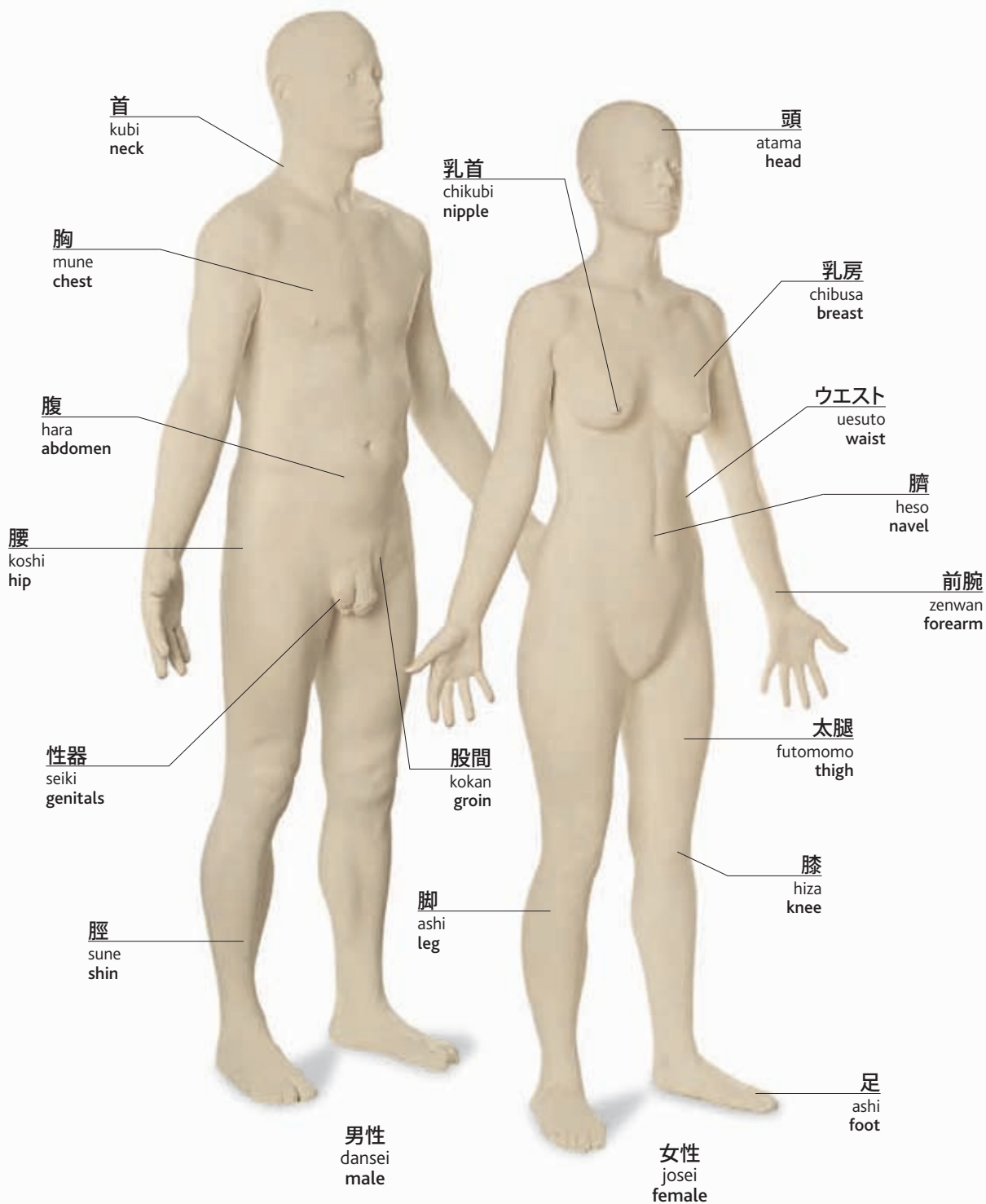

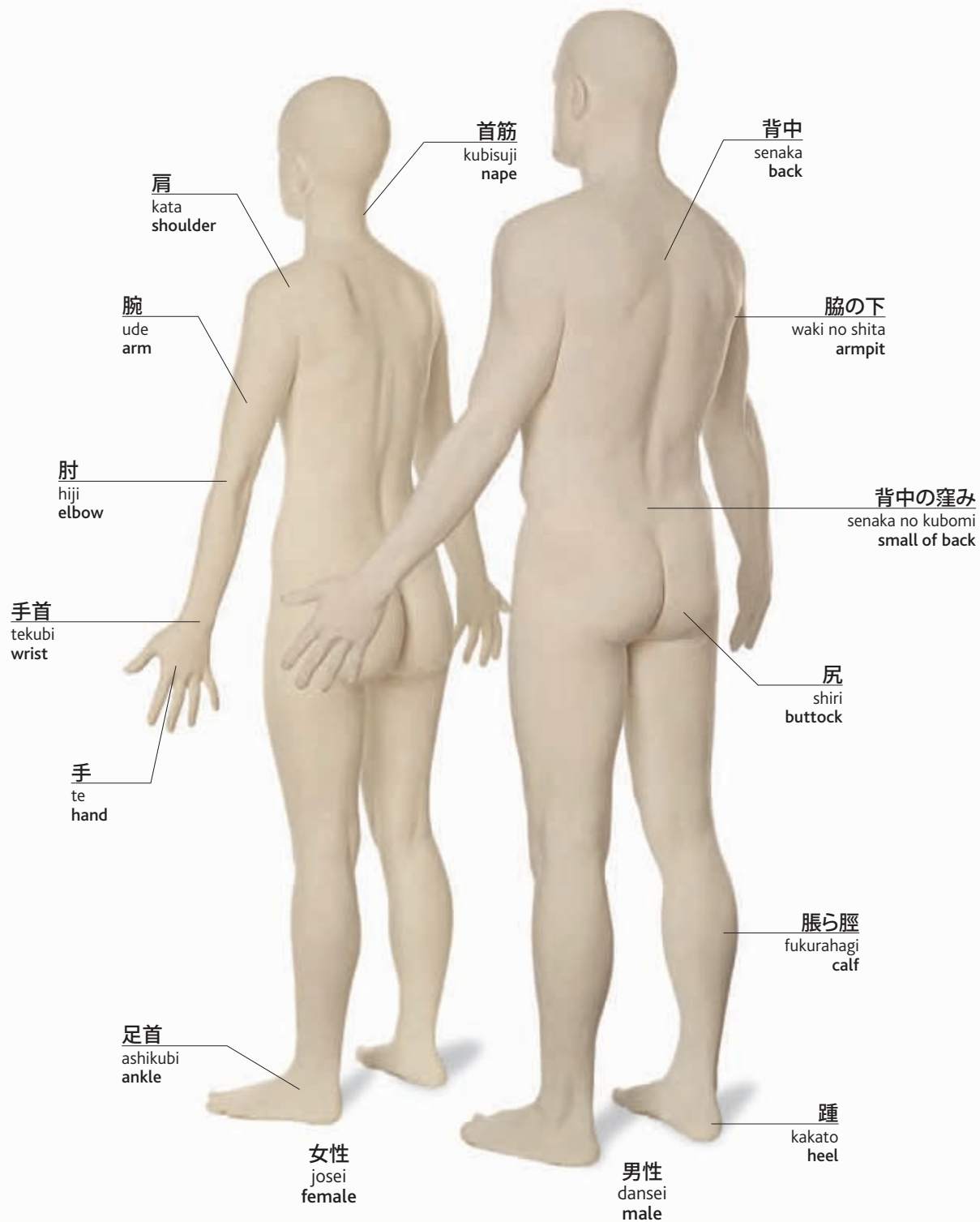

# 顔 kao • face

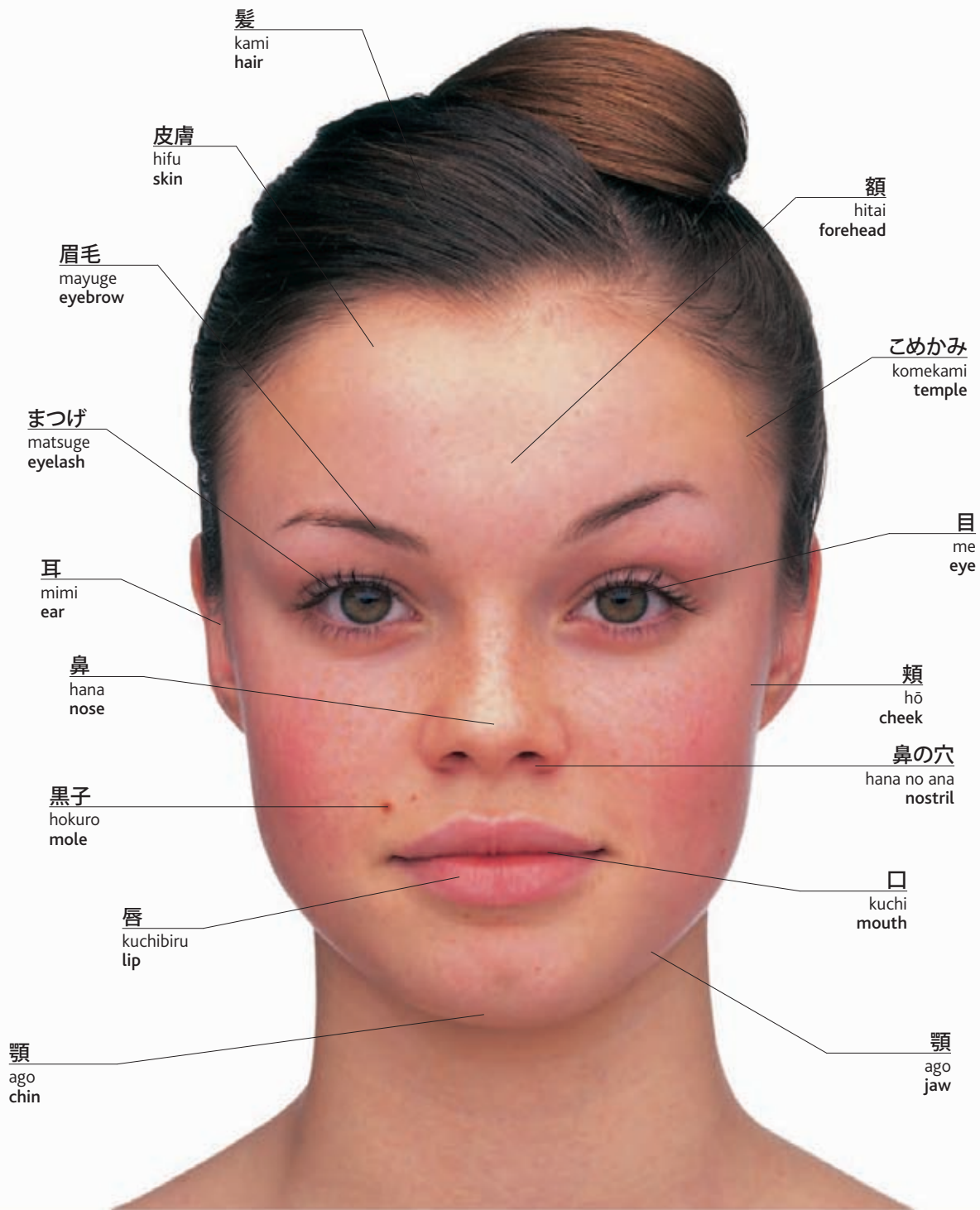





皺  
shiwa  
wrinkle



そばかす  
sobakasu  
freckle



毛穴  
keana  
pore

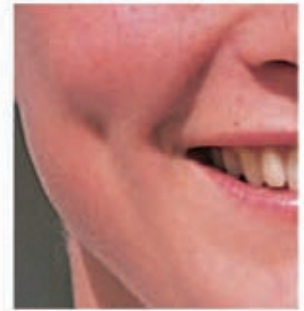

えくぼ  
ekubo  
dimple

## 手 te • hand



## 足 ashi • foot

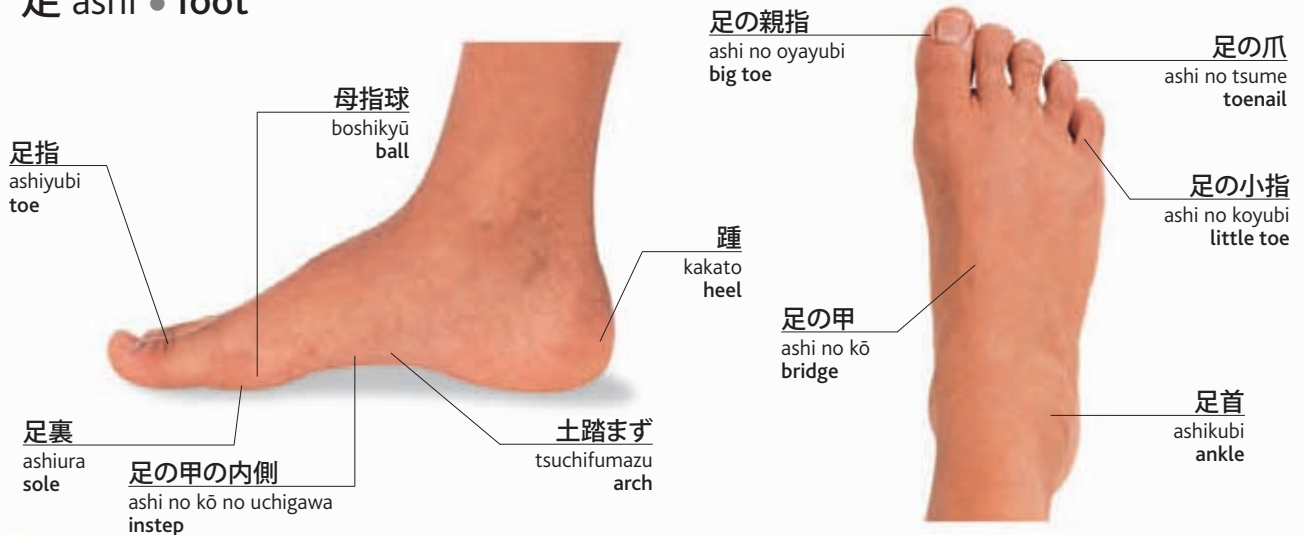

# 筋肉 kinniku • muscles

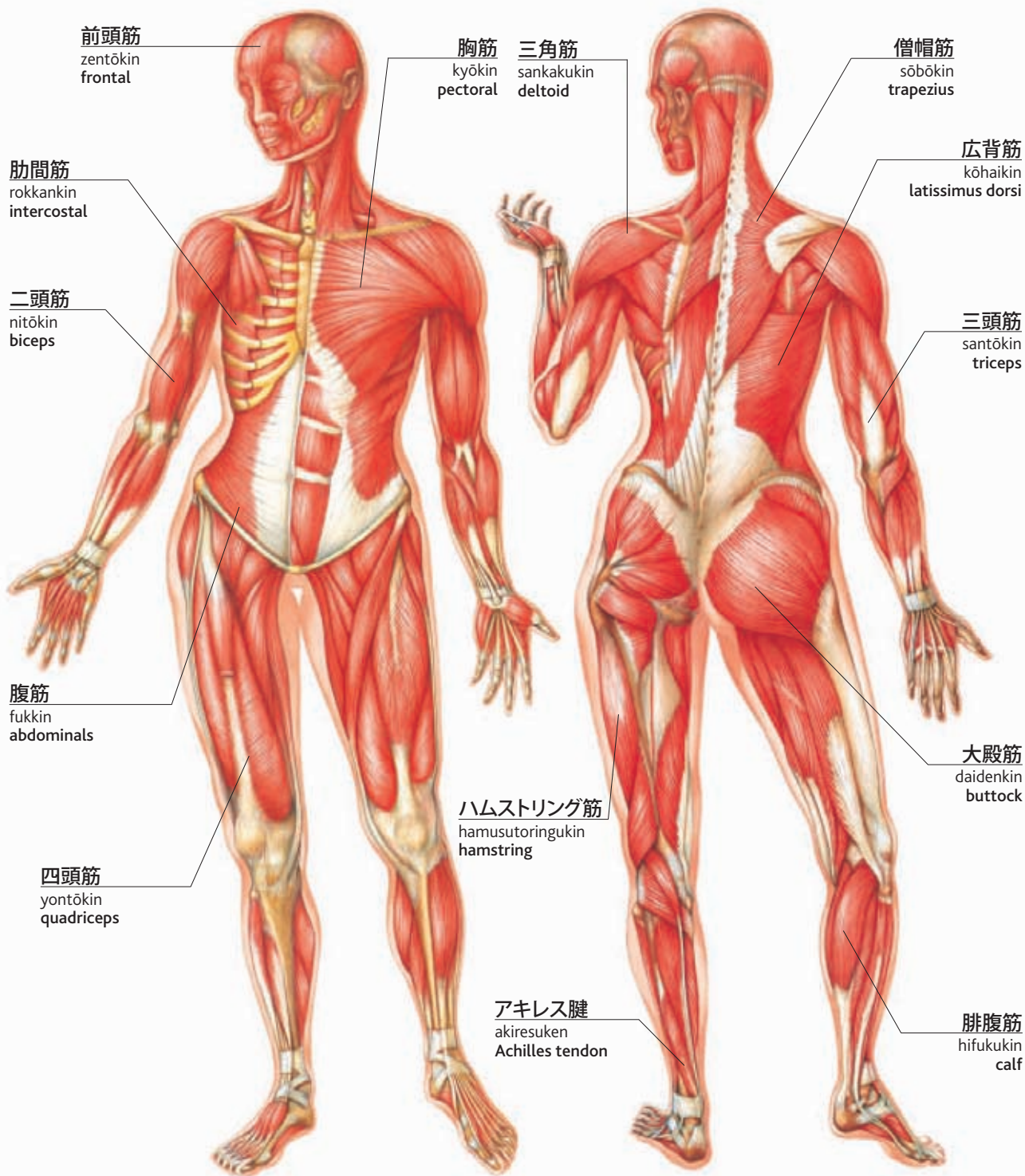



# 骨格 kokkaku • skeleton

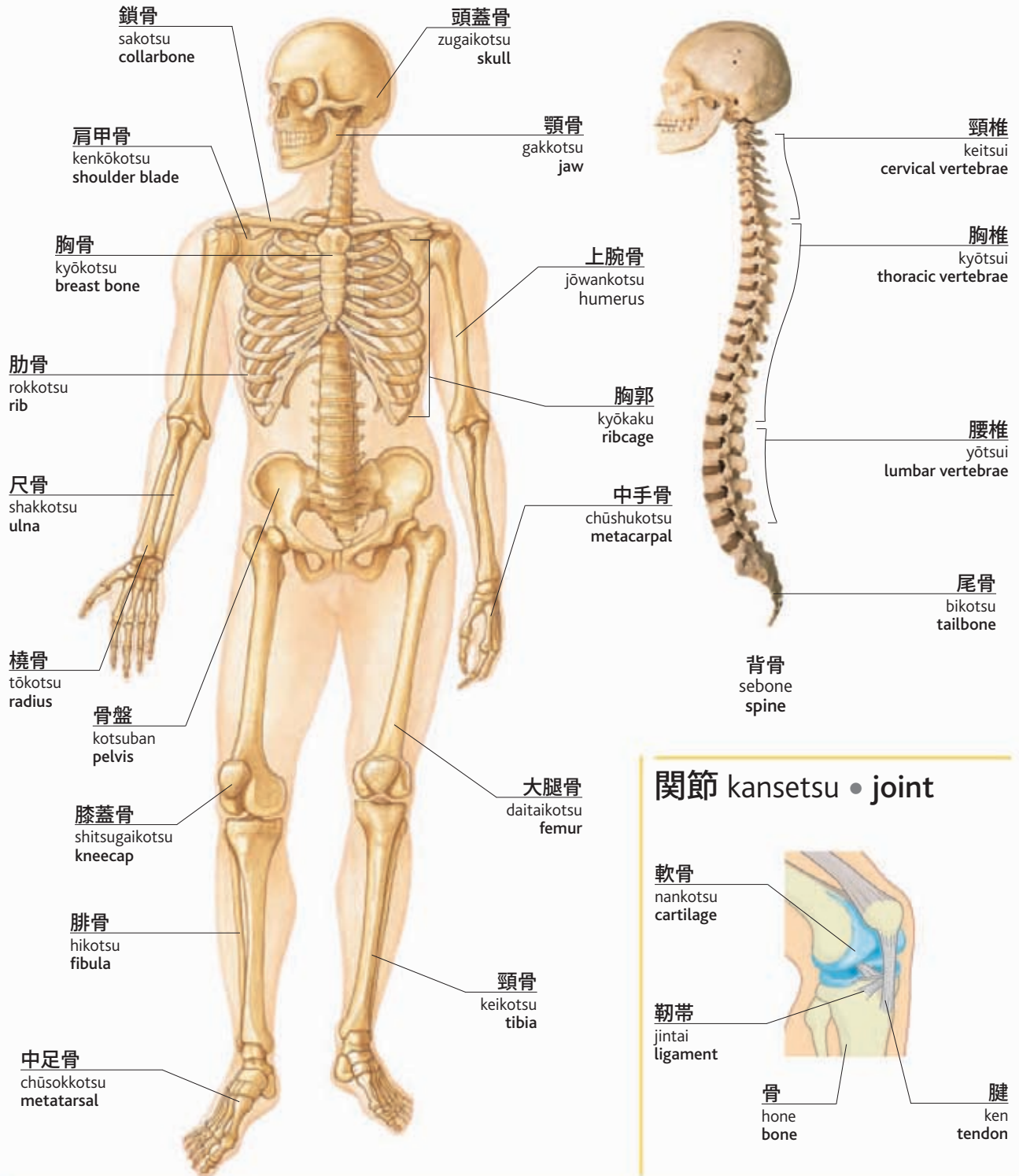

# 内蔵 naizō • internal organs

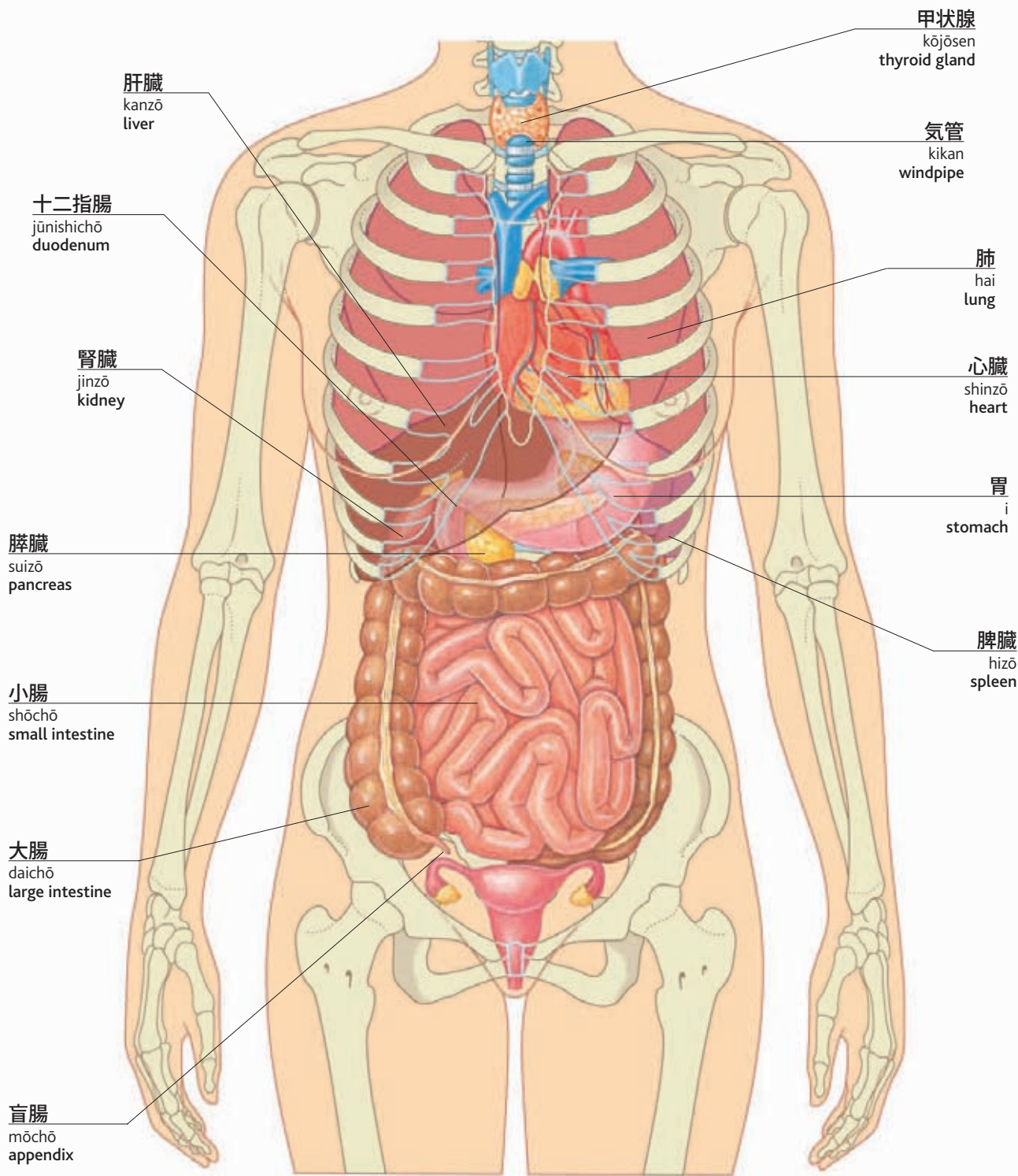

頭 atama • head

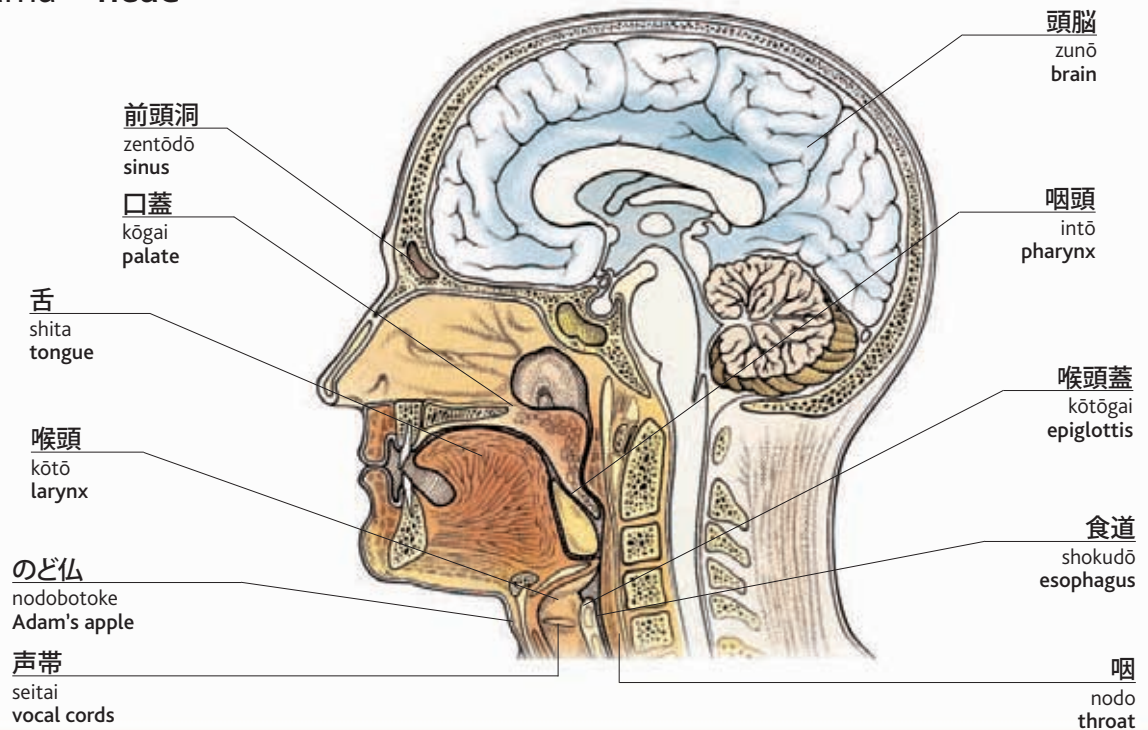

人体系統 jintai keitō • body systems



呼吸器系  
kokyūki kei  
respiratory

横隔膜  
ōkakumaku  
diaphragm



消化器系  
shōkaki kei  
digestive

静脈  
jōmyaku  
vein



循環系  
junkan kei  
cardiovascular

動脈  
dōmyaku  
artery



リンパ系  
rimpa kei  
lymphatic



泌尿器系  
hinyōki kei  
urinary



内分泌系  
naibumpi kei  
endocrine

腺  
sen  
gland



神経系  
shinkei kei  
nervous

神経  
shinkei  
nerve



生殖器系  
seishokuki kei  
reproductive



# 生殖器 seishokuki • reproductive organs

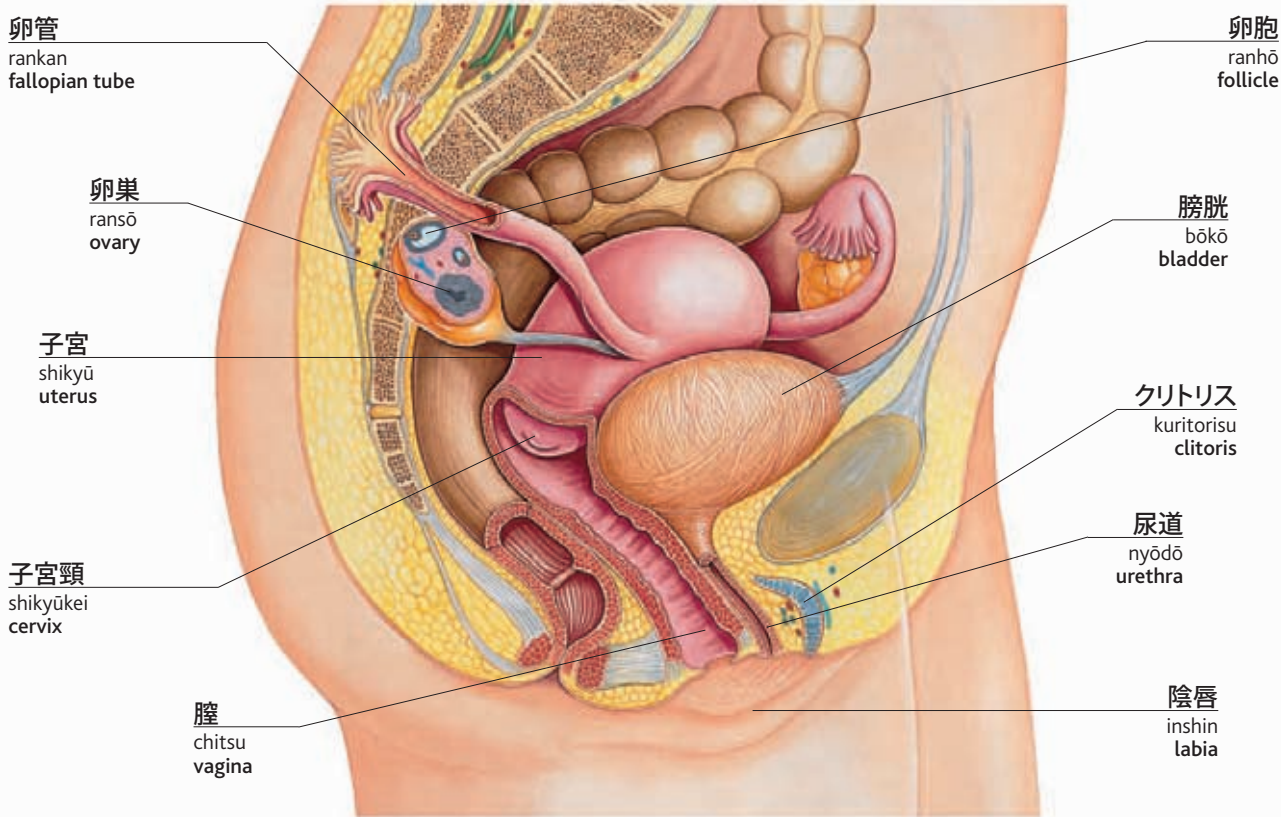

女性 josei | female

## 生殖 seishoku • reproduction

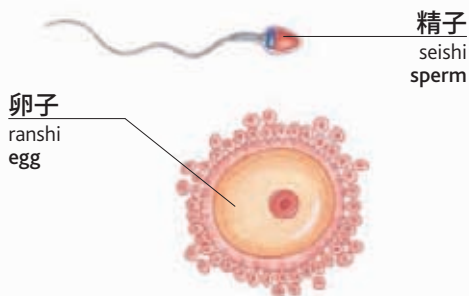

受精 jusei | fertilization

## 関連用語 kanrenyōgo • vocabulary

|                              |                                  |   |
|------------------------------|----------------------------------|---|
| ホルモン<br>horumon<br>hormone   | 不能症<br>funōshō<br>impotent       | 妊娠できる<br>ninshin dekiru<br>fertile                    |
| 排卵<br>hairan<br>ovulation    | 妊娠する<br>ninshin suru<br>conceive | 月経<br>gekkei<br>menstruation                          |
| 不妊症<br>funinshō<br>infertile | 性交<br>seikō<br>intercourse       | 性感染症<br>sei kansenshō<br>sexually transmitted disease |

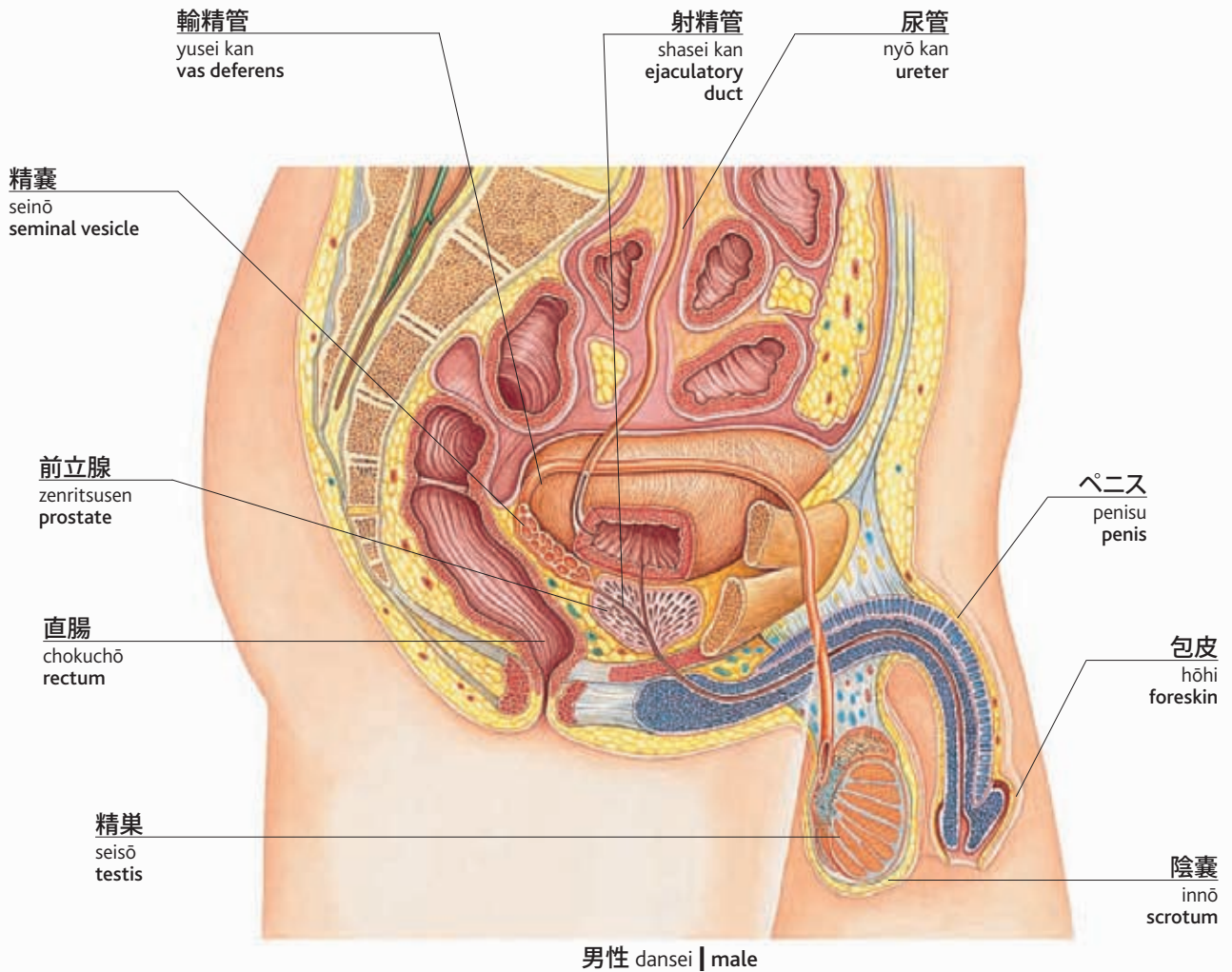

避妊 hinin • contraception



# 家族 kazoku • family

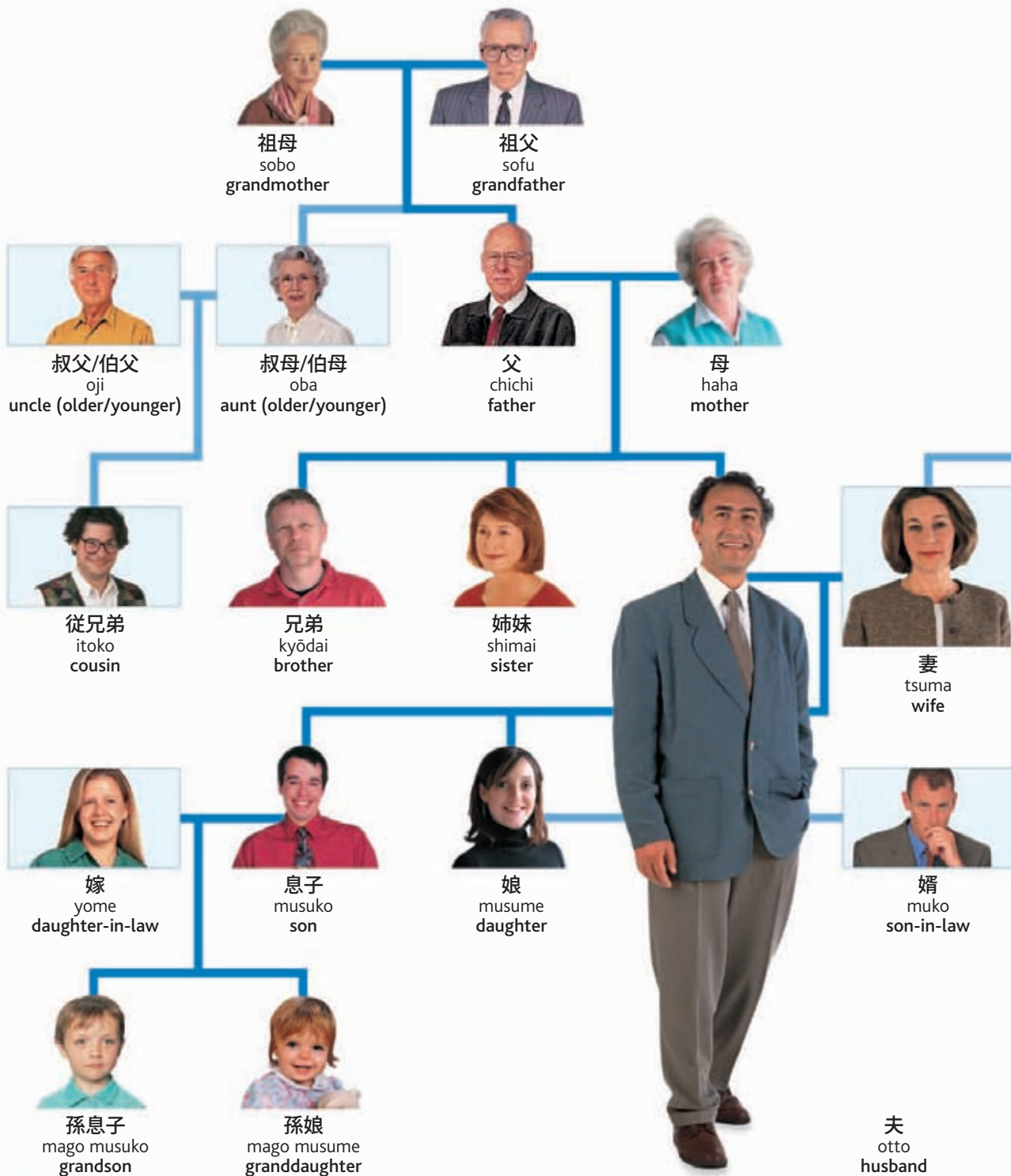



関連用語 kanrenyōgo • vocabulary

|                            |                          |                               |                                 |                                   |                            |
|----------------------------|--------------------------|-------------------------------|---------------------------------|-----------------------------------|----------------------------|
| 親類<br>shinrui<br>relatives | 両親<br>ryōshin<br>parents | 孫<br>mago<br>grandchildren    | 継母<br>mama haha<br>stepmother   | 継息子<br>mama musuko<br>stepson     | 配偶者<br>haigūsha<br>partner |
| 世代<br>sedai<br>generation  | 子供<br>kodomo<br>children | 祖父母<br>sofubo<br>grandparents | 継父<br>mama chichi<br>stepfather | 継娘<br>mama musume<br>stepdaughter | 双子<br>futago<br>twins      |



義母  
gibo  
mother-in-law

義父  
gifu  
father-in-law



義兄弟  
gikyōdai  
brother-in-law

義理の姉妹  
giri no shimai  
sister-in-law



姪  
mei  
niece

甥  
oi  
nephew

敬称 keishō • titles

ちゃん  
chan  
Miss/Master

さん  
san  
Mr.



成長段階 seichō dankai  
• stages



乳児  
nyūji  
baby



子供  
kodomo  
child



男の子  
otoko no ko  
boy



女の子  
onna no ko  
girl



ティーンエイジャー  
tin'ejā  
teenager



大人  
otona  
adult



男性  
dansei  
man



女性  
josei  
woman

# 人間関係 ningen kankei • relationships

マネージャー  
manējā  
manager

アシスタント  
ashisutanto  
assistant

ビジネス・パートナー  
bijinesu pātōnā  
business partner

雇用主  
koyōnushi  
employer

従業員  
jūgyōin  
employee

同僚  
dōryō  
colleague



オフィス ofisu | office



隣人  
rinjin  
neighbor



友人  
yūjin  
friend



知人  
chijin  
acquaintance



ペンパル  
pemparu  
pen pal

ボーイフレンド  
bōifurendo  
boyfriend



カップル kappuru | couple

ガールフレンド  
gārufurendo  
girlfriend

婚約者  
kon'yakusha  
fiancé



婚約者  
kon'yakusha  
fiancée

婚約中のカップル kon'yaku-chū no kappuru | engaged couple



## 感情 kanjō • emotions



微笑  
bishō  
smile

嬉しい  
ureshī  
happy



悲しい  
kanashī  
sad



興奮する  
kōfun suru  
excited



飽きる  
akiru  
bored



驚く  
odoroku  
surprised



怖がる  
kowagaru  
scared



しか目面  
shikame-zura  
frown

怒る  
okoru  
angry



混乱する  
konran suru  
confused



心配する  
shimpai suru  
worried



不安  
fuan  
nervous



誇る  
hokoru  
proud



自信  
jishin  
confident



恥ずかしい  
hazukashī  
embarrassed



はにかむ  
hanikamu  
shy

## 関連用語 kanrenyōgo • vocabulary

狼狽する  
rōbai suru  
upset

笑う  
warau  
laugh (v)

溜息をつく  
tameiki o tsuku  
sigh (v)

怒鳴る  
donaru  
shout (v)

衝撃を受ける  
shōgeki o ukeru  
shocked

泣く  
naku  
cry (v)

気絶する  
kizetsu suru  
faint (v)

欠伸する  
akubi suru  
yawn (v)

# 人生 jinsei • life events



生まれる  
umareru  
be born (v)



入学する  
nyūgaku suru  
start school (v)



友達になる  
tomodachi ni naru  
make friends (v)



卒業する  
sotsugyō suru  
graduate (v)



就職する  
shūshoku suru  
get a job (v)



恋愛する  
ren'ai suru  
fall in love (v)



結婚する  
kekkon suru  
get married (v)



出産する  
shussan suru  
have a baby (v)



結婚式 kekkonshiki | wedding



離婚  
rikon  
divorce



葬式  
sōshiki  
funeral

## 関連用語 kanrenyōgo • vocabulary

洗礼  
senrei  
christening

遺言状を書く  
yuigonjō o kaku  
make a will (v)

記念日  
kinembi  
anniversary

出生証明書  
shusseishi shōmeisho  
birth certificate

移民する  
imin suru  
emigrate (v)

結婚披露宴  
kekkon hirōen  
wedding reception

退職する  
taishoku suru  
retire (v)

ハネムーン  
hanemūn  
honeymoon

死ぬ  
shinu  
die (v)

バルミツバー  
barumitsubā  
bar mitzvah



お祝い oiwai • celebrations

誕生日パーティー  
tanjō pātī  
birthday party



誕生日  
tanjōbi  
birthday

カード  
kādo  
card



プレゼント  
purezento  
present



クリスマス  
kurisumasu  
Christmas

祭り matsuri  
• festivals



逾越祭  
sugikoshimatsuri  
Passover



正月  
shōgatsu  
New Year



カーニバル  
kānibaru  
carnival

行列  
gyōretsu  
procession



ラマダーン  
ramadān  
Ramadan

リボン  
ribon  
ribbon



感謝祭  
kanshasai  
Thanksgiving



復活祭  
fukkatsusai  
Easter



ハロウィーン  
harowīn  
Halloween



ディワリー  
diwārī  
Diwali









外觀 gaikan  
appearance

# 子供服 kodomo fuku • children's clothing

## 赤ちゃん akachan • baby



肌着  
hadagi  
bodysuit

ベビーグロー  
bebīgurō  
onesie

スナップ  
sunappu  
snap



スリープスーツ  
surīpusūtsu  
sleeper



スノースーツ  
sunōsūtsu  
snowsuit



ロンパース  
rompāsu  
romper



よだれ掛け  
yodarekake  
bib



ミトン  
miton  
mittens



ブーツィ  
būti  
booties



おむつ  
omutsu  
terrycloth diaper



紙おむつ  
kami omutsu  
disposable diaper



おむつカバー  
omutsu kabā  
plastic pants

## 幼児 yōji • toddler



日よけ帽  
hiyokebō  
sun hat



エプロン  
epuron  
apron



半ズボン  
hanzubon  
shorts

オーバーオール  
ōbāōru  
overalls



Tシャツ  
tīshatsu  
t-shirt



スカート  
sukāto  
skirt



子供 kodomo • child



ワンピース  
wampīsu  
dress

フード  
fūdo  
hood

ジーパン  
jīpan  
jeans

サンダル  
sandaru  
sandals

夏  
natsu  
summer



レインコート  
reinkōto  
raincoat



リュックサック  
ryukkusakku  
backpack

トグルボタン  
togurubotan  
toggle

秋  
aki  
fall



ダッフルコート  
daffurukōto  
duffel coat



マフラー  
mafurā  
scarf

アノラック  
anorakku  
parka

長靴  
nagagutsu  
rain boots

冬  
fuyu  
winter



ナイトガウン  
naitogaun  
bathrobe

ロゴ  
rogo  
logo

スニーカー  
sunikā  
athletic shoes

ネグリジェ  
negurije  
nightgown

スリッパ  
surippa  
slippers

寝間着  
nemaki  
nightwear



サッカー着  
sakkā-gi  
soccer uniform



トラックスーツ  
torakkusūtsu  
running suit



レギンス  
reginsu  
leggings

関連用語 kanrenyōgo • vocabulary

天然繊維  
tennen sen'i  
natural fiber

合成繊維  
gōsei sen'i  
synthetic fiber

洗濯機で洗えますか。  
sentakki de araemasuka?  
Is it machine washable?

2歳児に着れますか。  
nisai-ji ni kiremasuka?  
Will this fit a two-year-old?

# 男性服 dansei fuku • men's clothing



襟  
eri  
collar

ネクタイ  
nekutai  
tie

ベルト  
beruto  
belt

ラペル  
raperu  
lapel

ボタンホール  
botanhōru  
buttonhole

袖口  
sodeguchi  
cuff

ポケット  
poketto  
pocket

上着  
uwagi  
jacket

ボタン  
botan  
button

ズボン  
zubon  
trousers

スーツ  
sūtsu  
business suit

コート  
kōto  
coat

裏地  
uraji  
lining

革靴  
kawagutsu  
leather  
shoes

## 関連用語 kanrenyōgo • vocabulary

ワイシャツ  
waishatsu  
shirt

ナイトガウン  
naitogaun  
bathrobe

トラックスーツ  
torakkusūtsu  
running suit

長い  
nagai  
long

カーディガン  
kādigan  
cardigan

下着  
shitagi  
underwear

レインコート  
reinkōto  
raincoat

短い  
mijikai  
short

もっと大きい／小さいサイズはありますか。  
motto ōki/chīsai saizu wa arimasuka?  
Do you have this in a larger/smaller size?

試着できますか。  
shichaku dekimasuka?  
May I try this on?





ブレザー  
burezā  
blazer



スポーツジャケット  
supōtsu jaketto  
sports jacket



ベスト  
besuto  
vest

Vネック  
buinekku  
v-neck

丸首  
marukubi  
round neck

Tシャツ  
tīshatsu  
t-shirt

スエットパンツ  
suettopantsu  
sweatpants



アノラック  
anorakku  
parka



トレーナー  
torēnā  
sweatshirt



ウインドブレーカー  
uindoburēkā  
windbreaker



セーター  
sētā  
sweater



パジャマ  
pajama  
pajamas



肌着  
hadagi  
undershirt

カジュアルウェア  
kajuaruwa  
casual wear



短パン  
tampan  
shorts



ブリーフ  
burifu  
briefs



ボクサーショーツ  
bokusāshōtsu  
boxer shorts



靴下  
kutsushita  
socks

# 女性服 josei fuku • women's clothing



ジャケット  
jaketto  
jacket

ネックライン  
nekkurain  
neckline

縫い目  
nuime  
seam

袖  
sode  
sleeve

くるぶし丈  
kurubushi-take  
ankle length

スカート  
sukāto  
skirt

裾  
susō  
hem

膝丈  
hiza-take  
knee-length

パンスト  
pansuto  
pantyhose

靴  
kutsu  
shoes



ストラップレス  
sutorappuresu  
strapless

ノースリーブ  
nōsurību  
sleeveless

イブニングドレス  
ibuningudoresu  
evening gown



ワンピース  
wampīsu  
dress



ブラウス  
burausu  
blouse

スラックス  
surakkusu  
slacks

カジュアルウェア  
kajuaruwea  
casual wear

ランジェリー ranjerī • lingerie



ナイトガウン  
naitogaun  
negligée



スリップ  
surippu  
slip

ストラップ  
sutorappu  
strap



キャミソール  
kyamisōru  
bra camisole



バスク  
basuku  
bustier

ガーター  
gātā  
suspenders



ストッキング  
sutokkingu  
stockings



パンスト  
pansuto  
pantyhose

ベスト  
besuto  
vest



パンティ  
panti  
panties



ブラジャー  
burajā  
bra



ネグリジェ  
negurije  
nightgown

結婚式 kekkonshiki • wedding

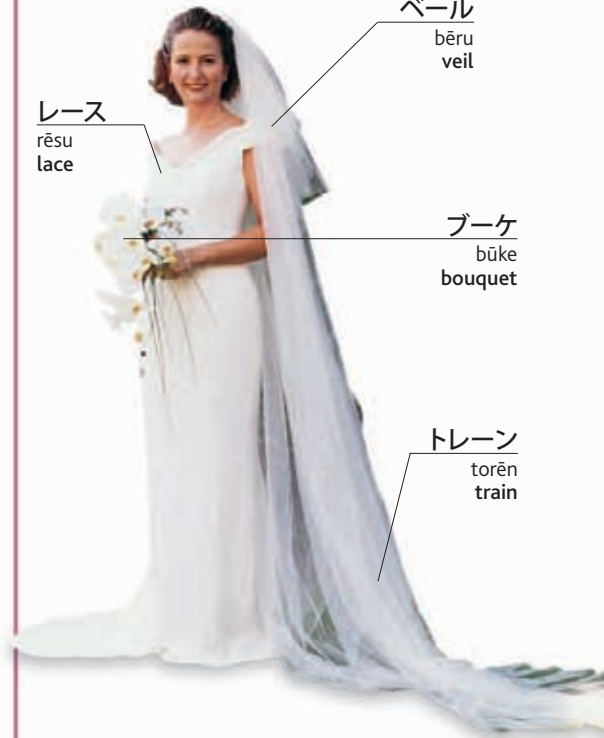

ベール  
bēru  
veil

レース  
rēsu  
lace

ブーケ  
būke  
bouquet

トレーン  
torēn  
train

ウェディングドレス  
wedingudoresu  
wedding dress

関連用語 kanrenyōgo  
• vocabulary

コルセット  
korusetto  
corset

テーラード  
tērādo  
tailored

ガーター  
gātā  
garter

ホールターネック  
hōrutā nekku  
halter neck

ショルダーパッド  
shorudāpaddo  
shoulder pad

ワイヤーカップ  
waiyā kappu  
underwired

ウエストバンド  
uesutobando  
waistband

スポーツ用ブラジャー  
supōtsu-yō burajā  
sports bra

着物  
kimono  
kimono



# 装身具 sōshingu • accessories



野球帽  
yakyūbō  
cap



帽子  
bōshi  
hat



スカーフ  
sukāfu  
scarf



ベルト  
beruto  
belt

柄  
e  
handle



先端  
sentan  
tip

傘  
kasa  
umbrella



ハンカチ  
hankachi  
handkerchief



蝶ネクタイ  
chōnekutai  
bow tie



ネクタイピン  
nekutai-pin  
tie clip



手袋  
tebukuro  
gloves

# アクセサリ akusesarī • jewellery



ペンダント  
pendanto  
pendant



ブローチ  
burōchi  
brooch



カフスボタン  
kafusubotan  
cufflink

真珠の首飾り  
shinju no kubikazari  
string of pearls

リンク  
rinku  
link

クラスプ  
kurasupu  
clasp

イヤリング  
iyaringu  
earring

指輪  
yubiwa  
ring

宝石  
hōseki  
stone

ネックレス  
nekkuresu  
necklace

腕時計  
udedokei  
watch



ブレスレット  
buresuretto  
bracelet



チェーン  
chēn  
chain



宝石箱 hōseki-bako | jewelry box

## バッグ baggu • bags



札入れ  
satsuire  
wallet



財布  
saifu  
change purse



ショルダーバッグ  
shorudābaggu  
shoulder bag

留め金  
tomegane  
fastening

ストラップ  
sutorappu  
shoulder strap

取っ手  
totte  
handles



旅行鞆  
ryokōkaban  
duffle bag



ブリーフケース  
burifukēsu  
briefcase



ハンドバッグ  
handobaggu  
handbag



リュックサック  
ryukkusakku  
backpack

## 靴 kutsu • shoes

靴紐穴  
kutsuhimo ana  
eyelet

靴紐  
kutsuhimo  
lace

べロ  
bero  
tongue

靴底  
kutsuzoko  
sole

踵  
kakato  
heel



編上靴  
amiagegutsu  
lace-up



ハイキングブーツ  
haikingu bŭtsu  
hiking boot



スニーカー  
sunikā  
athletic shoe



革靴  
kawagutsu  
leather shoe



ゴム草履  
gomuzōri  
flip-flop



ハイヒール  
haihiru  
high-heeled shoe



プラットフォームシューズ  
purattofōmu shūzu  
platform shoe



サンダル  
sandaru  
sandal



スリッポン  
surippon  
slip-on



短靴  
tangutsu  
wingtip

# 髪 kami • hair



櫛  
kushi  
comb

櫛で梳く  
kushi de suku  
comb (v)



ヘアブラシ  
heaburashi  
brush

ブラシをかける  
burashi o kakeru | brush (v)



濯ぐ  
yusugu  
rinse (v)



髪結い  
kamiyui  
hairdresser

シャンプー台  
shampū dai  
sink

客  
kyaku  
client

洗う arau | wash (v)



ガウン  
gaun  
cape

カットする  
katto suru  
cut (v)



ブローする  
burō suru  
blow dry (v)



セットする  
setto suru  
set (v)

# 備品 bihin • accessories



ヘアドライヤー  
headoraiyā  
hairdryer



シャンプー  
shampū  
shampoo



コンディショナー  
kondishonā  
conditioner



ジェル  
jeru  
gel



ヘアスプレー  
heasupurē  
hairspray



鋏  
hasami  
scissors



ヘアバンド  
heabando  
headband



カーラー  
kāra  
curler



ヘアピン  
heapin  
bobby pin



カールアイロン  
kāru airon  
curling iron



## 髪型 kamigata • styles



ポニーテール  
ponitēru  
ponytail

リボン  
ribon  
ribbon



三つ編み  
mitsuami  
braid



フレンチブリーツ  
furenchi purītsu  
french twist



お団子  
odango  
bun



お下げ  
osage  
pigtails



ボブ  
bobu  
bob



坊ちゃん刈り  
botchangari  
crop



カール  
kāru  
curly



パーマ  
pāma  
perm



ストレート  
sutorēto  
straight



ハイライト  
hairaito  
highlights

毛根  
mōkon  
roots



はげ頭  
hageatama  
bald



髪  
katsura  
wig

### 関連用語 kanrenyōgo • vocabulary

整髪する  
seihatsu suru  
trim (v)

脂質  
abura shitsu  
greasy

ストレートにする  
sutorēto ni suru  
straighten (v)

乾燥質  
kansō shitsu  
dry

床屋  
tokoya  
barber

普通  
futsū  
normal

フケ  
fuke  
dandruff

頭皮  
tōhi  
scalp

枝毛  
edage  
split ends

ヘアタイ  
heatai  
hair tie

## ヘアカラー hea karā • colors



ブロンド  
burondo  
blonde



ブルネット  
burunetto  
brunette



赤茶色  
akachairo  
auburn



赤毛  
akage  
ginger



黒髪  
kurokami  
black



グレー  
gurē  
gray



ホワイト  
howaito  
white



染髪  
sempatsu  
dyed

# 美容 biyō • beauty



ヘアカラー  
heakarā  
hair dye

アイシャドー  
aishadō  
eye shadow

マスカラ  
masukara  
mascara

アイライナー  
airainā  
eyeliner

頬紅  
hōbeni  
blusher

ファンデーション  
fandeshon  
foundation

口紅  
kuchibeni  
lipstick

## メーキャップ mēkyappu • makeup



アイブロウペンシル  
aiburow penshiru  
eyebrow pencil



アイブロウブラシ  
aiburow burashi  
eyebrow brush



毛抜き  
kenuki  
tweezers



リップグロス  
rippu gurosu  
lip gloss



リップブラシ  
rippu burashi  
lip brush



リップライナー  
rippu rainā  
lip liner



ブラシ  
burashi  
brush



コンシーラー  
konshirā  
concealer

コンパクトミラー  
kompakuto mirā  
mirror

白粉  
oshiroi  
face powder

パフ  
pafu  
powder puff



コンパクト kompakuto | compact

エステ esute • beauty treatments

フェースパック  
fēsu pakuu  
facial mask



サンベッド  
sambeddo  
sunbed



フェーシャル  
fēsharu  
facial



角質除去する  
kakushitsu jokyo suru  
exfoliate (v)



ワックス  
wakkusu  
wax



ペディキュア  
pedikyua  
pedicure



マニキュア manikyua • manicure

除光液  
jokō eki  
nail varnish remover



爪やすり  
tsume yasuri  
nail file



マニキュア  
manikyua  
nail varnish



爪切り  
tsumekiri  
nail scissors



爪切り  
tsumekiri  
nail clippers



化粧品 keshōhin • toiletries

クレンザー  
kurenzā  
cleanser



化粧水  
keshōsui  
toner



乳液  
nyūeki  
moisturizer



セルフタンニング・クリーム  
serufu tanningu kurīmu  
self-tanning cream



香水  
kōsui  
perfume



オードトワレ  
ōdotoware  
eau de toilette



関連用語 kanrenyōgo • vocabulary

肌の色  
hada no iro  
complexion

脂肌  
abura hada  
oily

日焼け  
hiyake  
tan

色白  
irojiro  
fair

敏感肌  
binkan hada  
sensitive

入れ墨  
irezumi  
tattoo

色黒  
iroguro  
dark

低刺激性  
tei-shigeki sei  
hypoallergenic

皺取り  
shiwa tori  
anti-wrinkle

乾燥肌  
kansō hada  
dry

色合い  
iroai  
shade

コットンボール  
kotton bōru  
cotton balls









健康 kenkō  
health



# 病気 byōki • illness



熱 netsu | fever



頭痛 zutsū  
headache



鼻血 hanaji  
nosebleed



咳 seki  
cough



くしゃみ kushami  
sneeze



風邪 kaze  
cold



インフルエンザ infuruenza  
flu



吸入器 kyūnyūki  
inhaler

喘息 zensoku  
asthma



腹痛 fukutsū  
cramps



吐き気 hakike  
nausea



水痘 suitō  
chickenpox



発疹 hosshin  
rash

## 関連用語 kanrenyōgo • vocabulary

脳卒中  
nōsotchū  
stroke

糖尿病  
tōnyōbyō  
diabetes

アトピー性皮膚炎  
atopisei hifuen  
eczema

悪寒  
okan  
chill

吐く  
haku  
vomit (v)

下痢  
geri  
diarrhea

血圧  
ketsuatsu  
blood pressure

アレルギー  
arerugi  
allergy

感染  
kansen  
infection

胃痛  
itsū  
stomach ache

癲癇  
tenkan  
epilepsy

麻疹  
hashika  
measles

心臓発作  
shinzōhossa  
heart attack

花粉症  
kafunshō  
hayfever

ウイルス  
uirusu  
virus

失神する  
shisshin suru  
faint (v)

片頭痛  
henzutsū  
migraine

おたふく風邪  
otafukukaze  
mumps



# 医者 isha • doctor

## 診察 shinsatsu • consultation

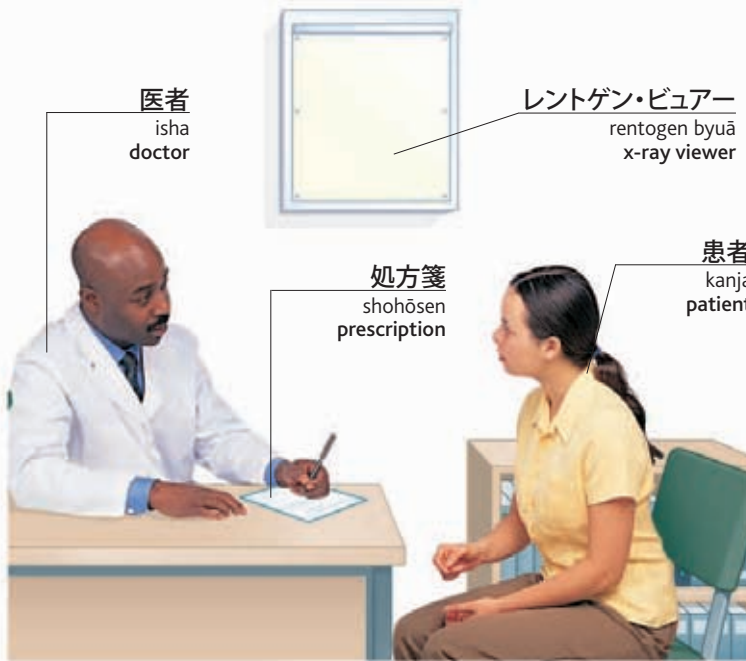

医者  
isha  
doctor

レントゲン・ビューアー  
rentogen byuā  
x-ray viewer

処方箋  
shohōsen  
prescription

患者  
kanja  
patient

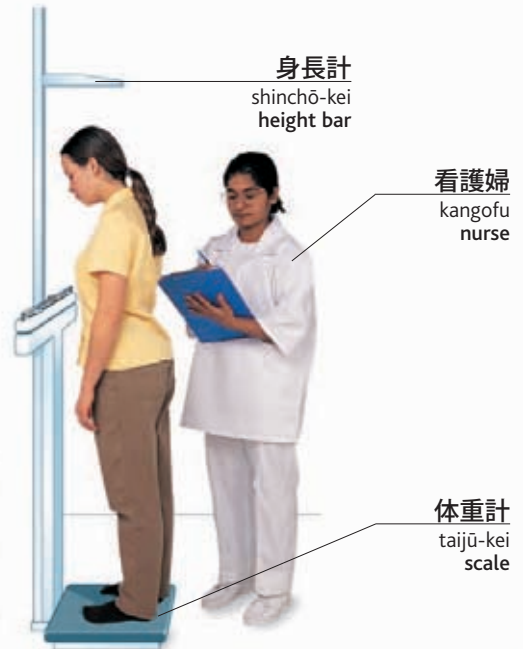

身長計  
shinchō-kei  
height bar

看護婦  
kangofu  
nurse

体重計  
taiju-kei  
scale

### 血圧計

ketsuatsukei  
blood pressure gauge

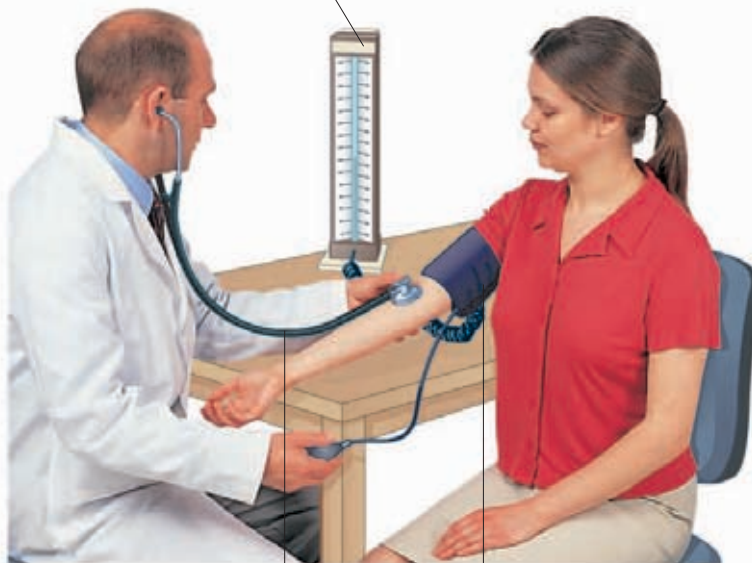

聴診器  
chōshinki  
stethoscope

加圧帯  
ka'atsutai  
cuff

### 関連用語 kanrenyōgo

#### • vocabulary

予約  
yoyaku  
appointment

予防接種  
yobō-sesshu  
inoculation

診療室  
shinryō-shitsu  
doctor's office

体温計  
taionkei  
thermometer

待合室  
machiai-shitsu  
waiting room

診察  
shinsatsu  
medical  
examination

医者に行かなければなりません。  
isha ni ikanakereba narimasen.  
I need to see a doctor.

ここが痛い。  
koko ga itai.  
It hurts here.

# 怪我 kega • injury



捻挫 nenza | sprain

三角布  
sankakufu  
sling



ギブス  
gibusu  
neck brace

骨折  
kossetsu  
fracture



鞭打ち症  
muchiuichishō  
whiplash



切り傷  
kirikizu  
cut



擦り傷  
surikizu  
abrasion



痣  
aza  
bruise



刺  
toge  
splinter



日焼け  
hiyake  
sunburn



火傷  
yakedo  
burn



かみ傷  
kamikizu  
bite



虫刺され  
mushi-sasare  
sting

## 関連用語 kanrenyōgo • vocabulary

事故  
jiko  
accident

出血  
shukketsu  
hemorrhage

中毒  
chūdoku  
poisoning

大丈夫でしょうか。  
daijōbu deshōka?  
Will he/she be all right?

緊急事態  
kinkyūjitai  
emergency

水ぶくれ  
mizbukure  
blister

感電  
kanden  
electric shock

どこが痛みますか。  
doko ga itamimasuka?  
Where does it hurt?

傷  
kizu  
wound

脳しんとう  
nōshintō  
concussion

頭部外傷  
tōbu gaishō  
head injury

救急車を呼んでください。  
kyūkyūsha o yonde kudasai.  
Please call an ambulance.

# 応急手当 ōkyū teate • first aid

軟膏  
nankō  
ointment

バンドエード  
bandoēdo  
adhesive bandage

安全ピン  
anzempin  
safety pin

包帯  
hōtai  
bandage

痛み止め  
itami-dome  
analgesics



消毒ワイプ  
shōdoku waipu  
antiseptic wipe

ピンセット  
pinsetto  
tweezers

鉗  
hasami  
scissors

消毒液  
shōdoku eki  
antiseptic

救急箱 kyūkyūbako | first aid box

ガーゼ  
gāze  
gauze



手当  
teate  
dressing



副木 fukuboku | splint



絆創膏  
bansōkō  
adhesive tape



救急蘇生  
kyūkyū sosei  
resuscitation

## 関連用語 kanrenyōgo • vocabulary

ショック  
shokku  
shock

脈拍  
myakuhaku  
pulse

窒息する  
chissoku  
suru  
choke (v)

助けてください。  
tasukete kudasai.  
Please help.

意識不明  
ishikifumei  
unconscious

呼吸  
kokyū  
breathing

殺菌  
sakkīn  
sterile

応急手当のやり方を知っていますか。  
ōkyū teate no yarikata o shitte imasuka?  
Do you know first aid?



# 病院 byōin • hospital

**外科医**  
geka-i  
surgeon

**看護婦**  
kangofu  
nurse

**手術室**  
shujutsu-shitsu  
operating room

**車輪付き担架**  
sharin-tsuki tanka  
gurney

**緊急治療室**  
kinkyū chiryō-shitsu  
emergency room

**呼び出しボタン**  
yobidashi botan  
call button

**病室**  
byōshitsu  
hospital room

**車椅子**  
kurumaisu  
wheelchair

**カルテ**  
karute  
chart

**麻酔士**  
masui-shi  
anesthesiologist

**血液検査**  
ketsueki kensa  
blood test

**注射**  
chūsha  
injection

**レントゲン**  
rentogen  
x-ray

**スキャン**  
sukyan  
scan

## 関連用語 kanrenyōgo • vocabulary

手術  
shujutsu  
operation

退院  
tai'in  
discharged

面会時間  
menkai jikan  
visiting hours

小児病棟  
shōni byōtō  
children's ward

集中治療室  
shūchū chiryō-shitsu  
intensive care unit

入院  
nyūin  
admitted

診療所  
shinryōjo  
clinic

産科病棟  
sanka byōtō  
maternity ward

個室  
koshitsu  
private room

外来患者  
gairaikanja  
outpatient

# 医療部門 iryō bumon • departments



耳鼻咽喉科  
jibi'inkō-ka  
ears, nose, and throat (ENT)



心臓病科  
shinzōbyō-ka  
cardiology



整形外科  
seikeige-ka  
orthopedics



婦人科  
fujin-ka  
gynecology



理学療法科  
rigakuryōhō-ka  
physical therapy



皮膚科  
hifu-ka  
dermatology



小児科  
shōni-ka  
pediatrics



放射線科  
hōshasen-ka  
radiology



外科  
geka  
surgery



産科  
sanka  
maternity



精神科  
seishin-ka  
psychiatry



眼科  
ganka  
ophthalmology

## 関連用語 kanrenyōgo • vocabulary

神経科  
shinkei-ka  
neurology

泌尿器科  
hinyōki-ka  
urology

内分泌科  
naibumpi-ka  
endocrinology

病理科  
byōri-ka  
pathology

結果  
kekka  
result

癌科  
gan-ka  
oncology

形成外科  
keisei-geka  
plastic surgery

照会  
shōkai  
referral

検査  
kensa  
test

専門医  
senmon'i  
specialist

# 歯医者 haisha • dentist

## 歯 ha • tooth

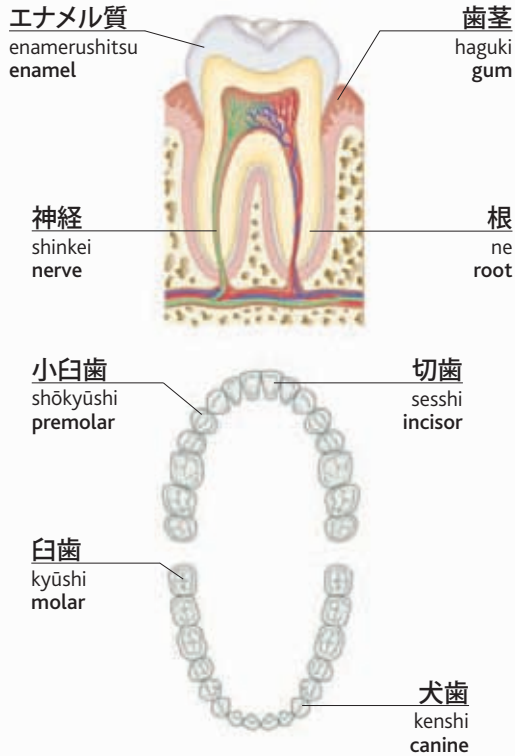

## 歯科検診 shika kenshin • checkup

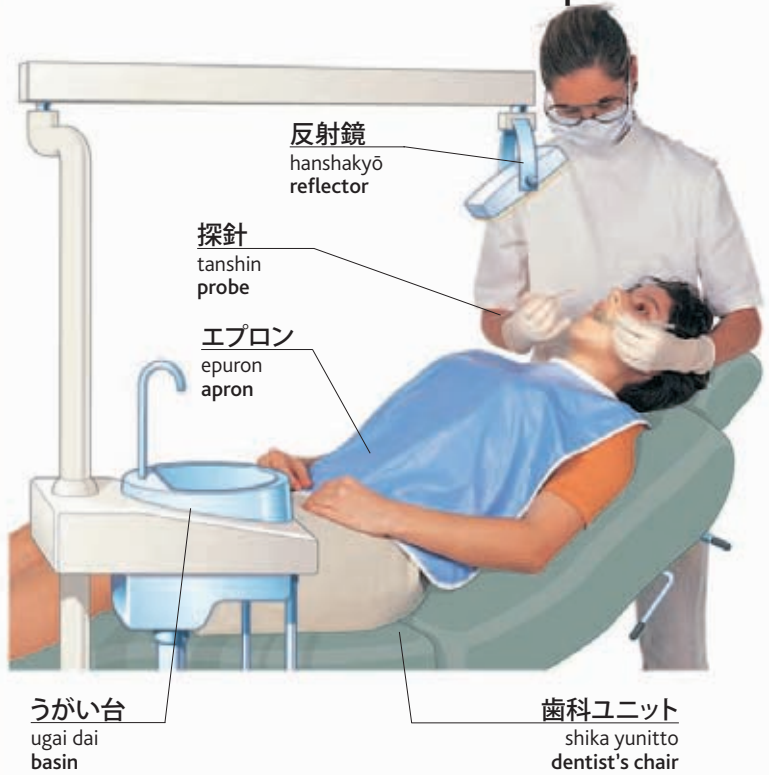

### 関連用語 kanrenyōgo

#### • vocabulary

歯痛 haita toothache

ドリル doriru drill

歯垢 shikō plaque

デンタルフロス dentaru furosu dental floss

虫歯 mushiba decay

抜歯 basshi extraction

詰め物 tsumemono filling

歯冠 shikan crown



デンタルフロスで掃除する dentaru furosu de sōji suru floss (v)



歯磨きする hamigaki suru brush (v)



歯列矯正ブリッジ shiretsu kyōsei burijji braces



歯科レントゲン shika rentogen dental x-ray



レントゲン写真 rentogen shashin x-ray film



入れ歯 ireba dentures



# 眼鏡店 megane-ten • optician



視力検査 shiryoku kensa | eye test

ケース  
kēsu  
case



眼鏡  
megane  
glasses

レンズ  
renzu  
lens



サングラス  
sangurasu  
sunglasses

フレーム  
furēmu  
frame

洗浄液  
senjō eki  
cleaning fluid



消毒液  
shōdoku eki  
disinfectant solution

レンズケース  
renzu kēsu  
lens case



コンタクトレンズ kontakutorenu | contact lenses

# 目 me • eye

眉毛  
mayuge  
eyebrow

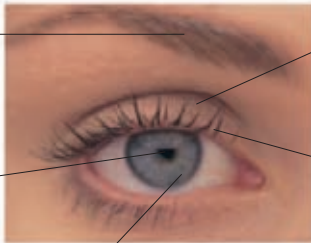

瞼  
mabuta  
eyelid

瞳孔  
dōkō  
pupil

まつげ  
matsuge  
eyelash

虹彩  
kōsai  
iris

網膜  
mōmaku  
retina

水晶体  
suishōtai  
lens

角膜  
kakumaku  
cornea

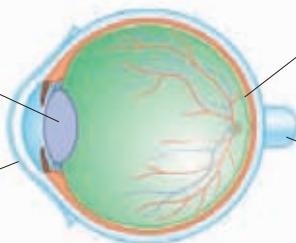

視神経  
shishinkei  
optic nerve

## 関連用語 kanrenyōgo • vocabulary

視力  
shiryoku  
vision

乱視  
ranshi  
astigmatism

ジオプター  
jioputā  
diopter

遠視  
enshi  
farsightedness

涙  
namida  
tear

近視  
kinshi  
nearsightedness

白内障  
hakunaishō  
cataract

遠近両用  
enkin ryōyō  
bifocal

# 妊娠 ninshin • pregnancy



看護婦  
kangofu  
nurse

妊娠テスト  
ninshin tesuto  
pregnancy test

スキャン  
sukyan  
scan

超音波(検査) chōmpa (kensa) | ultrasound (test)

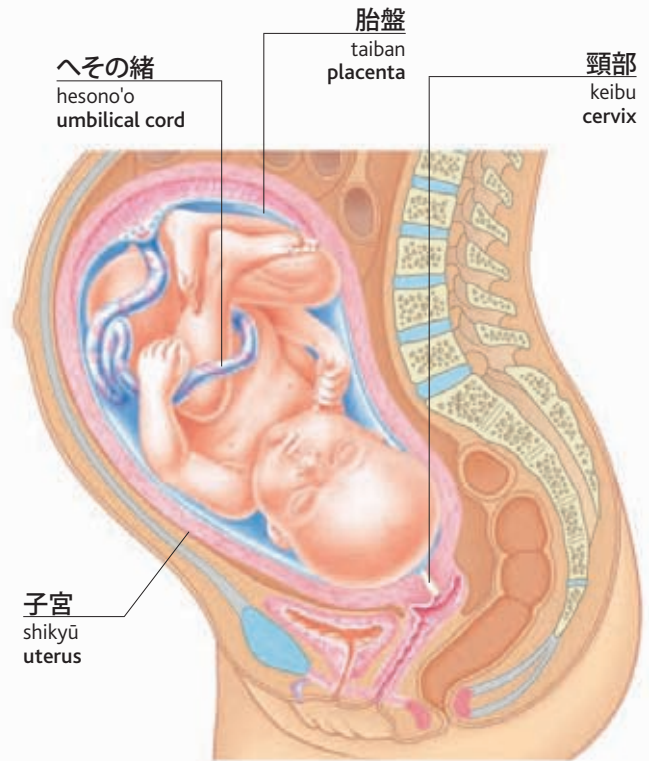

へその緒  
hesono'o  
umbilical cord

胎盤  
taiban  
placenta

頸部  
keibu  
cervix

子宮  
shikyū  
uterus

胎児 taiji | fetus

## 関連用語 kanrenyōgo • vocabulary

排卵  
hairan  
ovulation

出産前  
shussan mae  
prenatal

陣痛  
jintsū  
contraction

子宮頸部拡張  
shikyū keibu kakuchō  
dilation

分娩  
bumben  
delivery

逆子  
sakago  
breech

受胎  
jutai  
conception

胚  
hai  
embryo

破水する  
hasui suru  
break waters (v)

硬膜外麻酔  
kōmaku-gai masui  
epidural

誕生  
tanjō  
birth

未熟児  
mijukuji  
premature

妊娠  
ninshin  
pregnant

子宮  
shikyū  
uterus

羊水  
yōsui  
amniotic fluid

会陰切開  
kai'in sekkai  
episiotomy

流産  
ryūzan  
miscarriage

婦人科医  
fujinka-i  
gynecologist

妊娠している  
ninshin shiteiru  
expectant

三半期  
sanhanki  
trimester

羊水穿刺  
yōsui senshi  
amniocentesis

帝王切開  
tei'ō sekkai  
cesarean section

縫合  
hōgō  
stitches

産科医  
sanka-i  
obstetrician

# 出産 shussan • childbirth

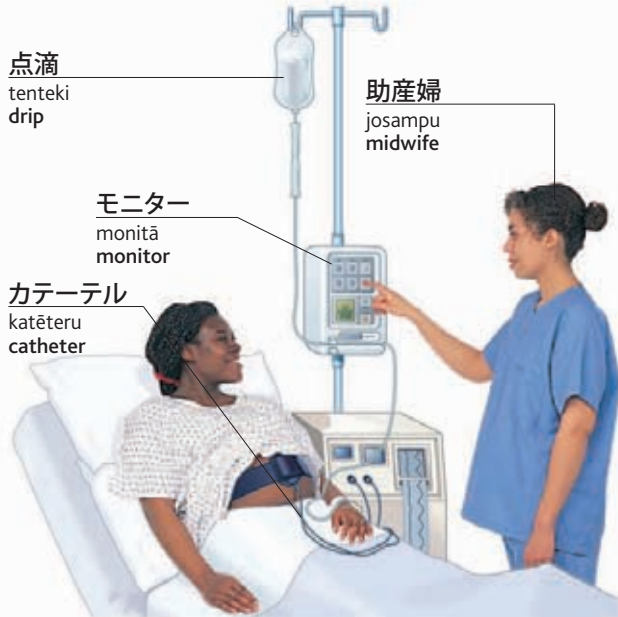

点滴  
tenteki  
drip

助産婦  
josampu  
midwife

モニター  
monitā  
monitor

カテーテル  
katēteru  
catheter

陣痛促進する jintsū sokushin suru | induce labor (v)



保育器 hoikuki | incubator



赤ちゃん用体重計  
akachan-yō taijūkei  
scale

出生時体重 shusseiji taijū | birth weight

鉗子  
kanshi  
forceps

真空カップ  
shinkū kappu  
suction cup

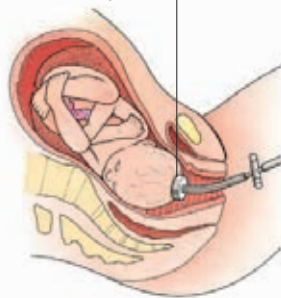
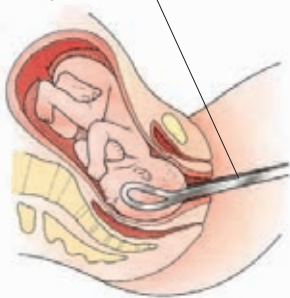

介助分娩  
kaijo bumben  
assisted delivery

識別バンド  
shikibetsu bando  
identification tag



新生児 shinseiji | newborn baby

## 授乳 junyū • nursing



搾乳機  
sakunyū-ki  
breast pump



授乳ブラジャー  
junyū burajā  
nursing bra



授乳する  
junyū suru  
breastfeed (v)



パッド  
paddo  
pads



# 代替療法 daitai ryōhō • alternative therapy



ヨガ yoga | yoga

マット  
matto  
mat

先生  
sensei  
teacher

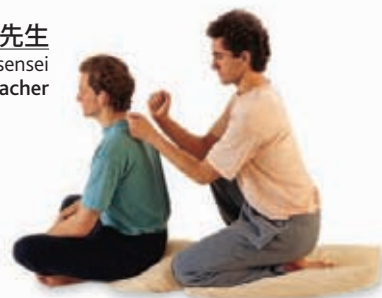

マッサージ  
massāji  
massage



指圧  
shiatsu  
shiatsu



瞑想  
meisō  
meditation



カイロプラクティック  
kairopurakutikku  
chiropractic



整骨療法  
seikotsu ryōhō  
osteopathy



リフレクソロジー  
rifurekusorojī  
reflexology

カウンセラー  
kaunserā  
counselor



グループ療法  
gurūpu ryōhō  
group therapy



レイキ療法  
reiki ryōhō  
reiki



鍼療法  
hari ryōhō  
acupuncture



アユルヴェーダ  
ayurveda  
ayurveda



催眠療法  
saimin ryōhō  
hypnoterapy



本草学  
honsō-gaku  
herbalism

精油  
seiyu  
essential oils



アロマセラピー  
aromaterapī  
aromatherapy



ホメオパシー  
homeopashī  
homeopathy



指圧療法  
shiatsu ryōhō  
acupressure therapy

療法士  
ryōhōshi  
therapist



心理療法  
shinri ryōhō  
psychotherapy

関連用語 kanrenyōgo • vocabulary

サプリメント  
sapurimento  
supplement

自然療法  
shizen ryōhō  
naturopathy

リラクゼーション  
rirakusēshon  
relaxation

薬草  
yakusō  
herb

水治療法  
suichi ryōhō  
hydrotherapy

風水  
fūsui  
feng shui

ストレス  
sutoresu  
stress

水晶療法  
suishō ryōhō  
crystal healing







A close-up photograph of a hand holding a green and yellow hairbrush against a red hairbrush. The background is a blurred mix of green, yellow, and red. A white horizontal band is overlaid on the right side of the image.

家庭 katei  
home

# 住宅 jūtaku • house

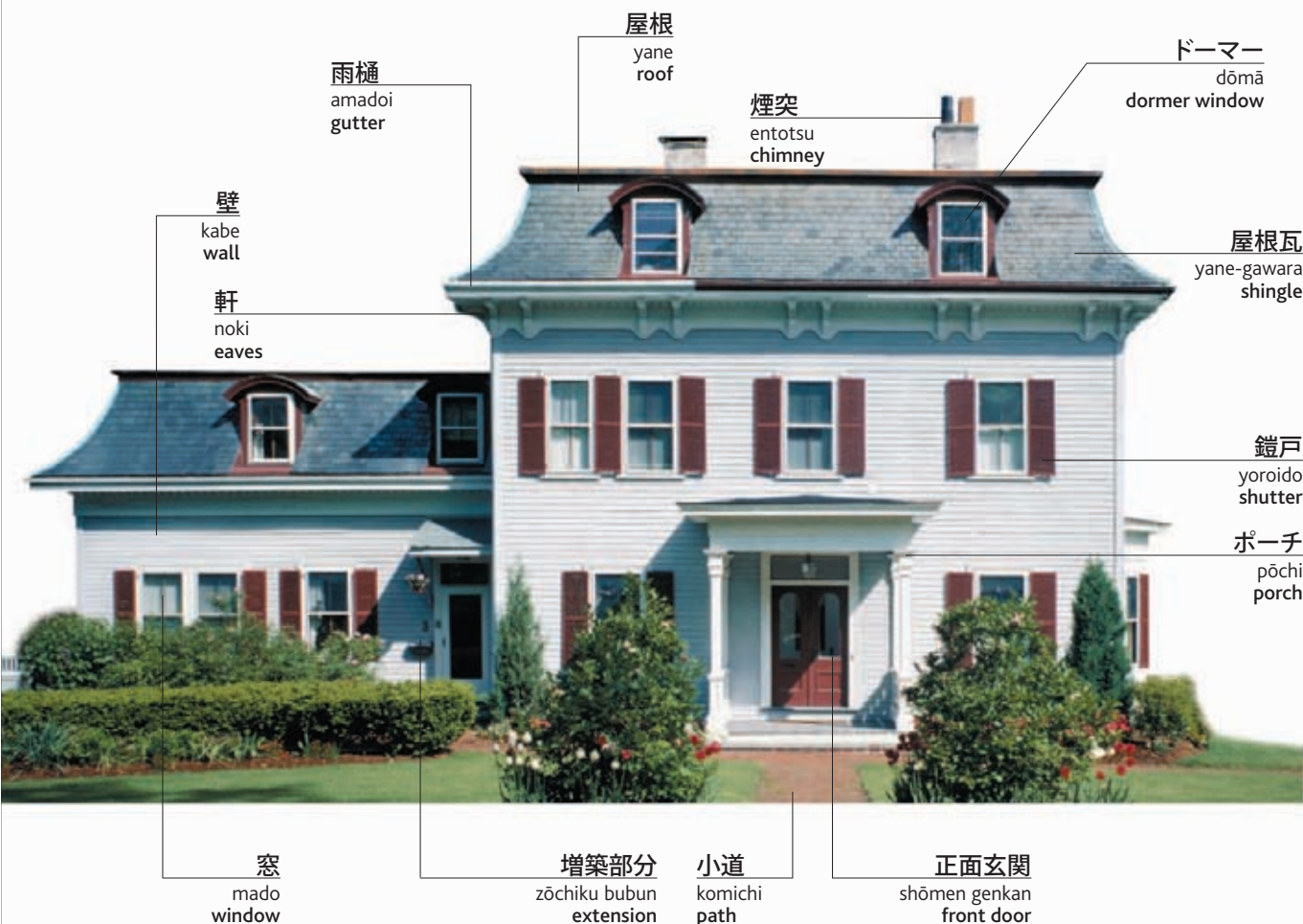

## 関連用語 kanrenyōgo • vocabulary

一戸建て  
ikkodate  
detached

借家人  
shakuyanin  
tenant

車庫  
shako  
garage

郵便受け  
yūbin-uke  
letter slot

防犯ベル  
bōhan beru  
burglar alarm

貸す  
kasu  
rent (v)

セミデタッチ  
semidetatchi  
semidetached

平屋  
hiraya  
bungalow

屋根裏部屋  
yaneura-beya  
attic

玄関灯  
genkan-tō  
porch light

中庭  
nakaniwa  
courtyard

家賃  
yachin  
rent

タウンハウス  
taunhausu  
townhouse

地下室  
chikashitsu  
basement

部屋  
heya  
room

大家  
ōya  
landlord

床  
yuka  
floor

テラス  
terasu  
terraced

入口 iriguchi • entrance



手摺  
tesuri  
hand rail

階段  
kaidan  
staircase

踊り場  
odoriba  
landing

階段の手摺  
kaidan no tesuri  
banister

玄関  
genkan  
hallway



呼び鈴  
yobirin  
doorbell



玄関マット  
genkan matto  
doormat



ドアノッカー  
doanokkā  
door knocker



ドアチェーン  
doachēn  
door chain

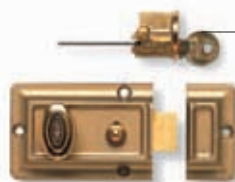

錠  
jō  
lock



門  
kannuki  
bolt

鍵  
kagi  
key

マンション manshon  
• apartment



ベランダ  
beranda  
balcony

マンション棟  
manshon-tō  
apartment building



インターホン  
intāhon  
intercom



エレベーター  
erebetā  
elevator



# 住宅内設備 jūtaku-nai setsubi • utilities



ラジエーター  
rajiētā  
radiator



ヒーター  
hītā  
space heater



羽  
hane  
blade

扇風機  
sempūki  
fan



ファンヒーター  
fanhītā  
portable heater

# 電気設備 denki setsubi • electricity



フィラメント  
firamento  
filament

接地ピン  
setchi pin  
ground prong

バヨネット式  
bayonetto-shiki  
thread

電球 denkyū | light bulb



プラグ puragu | plug

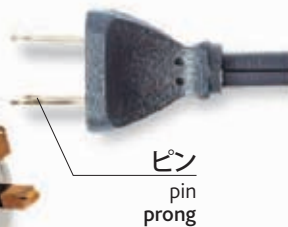

ピン  
pin  
prong

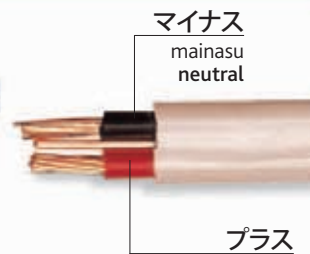

マイナス  
mainasu  
neutral

プラス  
purasu  
live

電線 densen | wires

## 関連用語 kanrenyōgo • vocabulary

電圧  
den'atsu  
voltage

ヒューズ  
hyūzu  
fuse

コンセント  
konsento  
outlet

直流連流  
chokuryū denryū  
direct current (DC)

停電  
teiden  
power outage

アンペア  
ampea  
amp

ヒューズボックス  
hyūzu bokkusu  
fuse box

スイッチ  
suitchi  
switch

変圧器  
hen'atsuki  
transformer

電源  
dengen  
domestic supply

電力  
denryoku  
power

発電機  
hatsudenki  
generator

交流電流  
kōryū denryū  
alternating current (AC)

電力量計  
denryokuryō-kei  
electricity meter

# 配管設備 haikan setsubi • plumbing

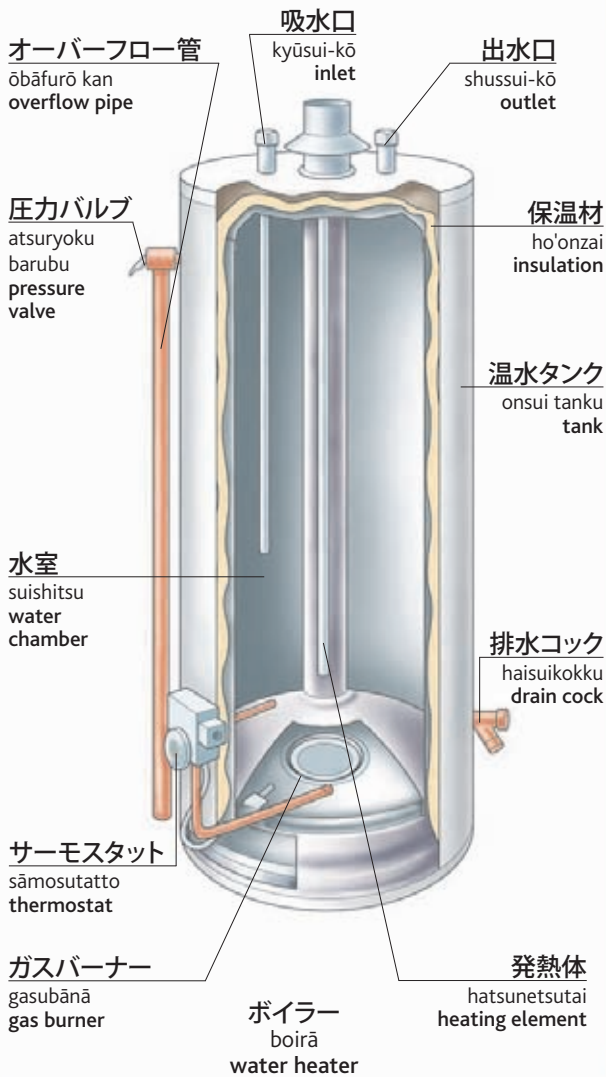

# 流し台 nagashidai • sink

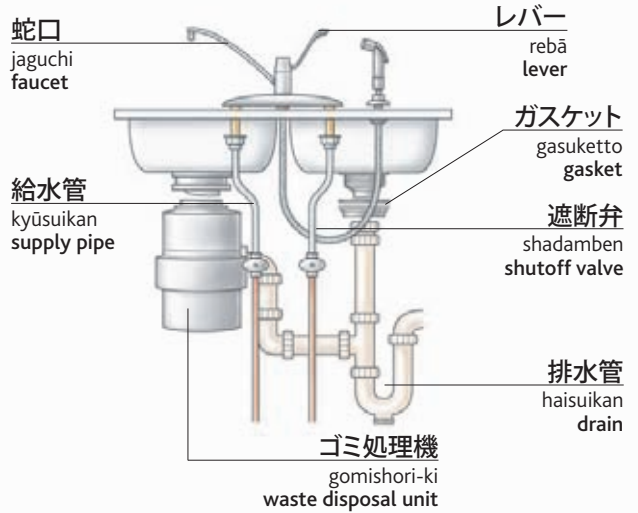

# トイレ toire • toilet

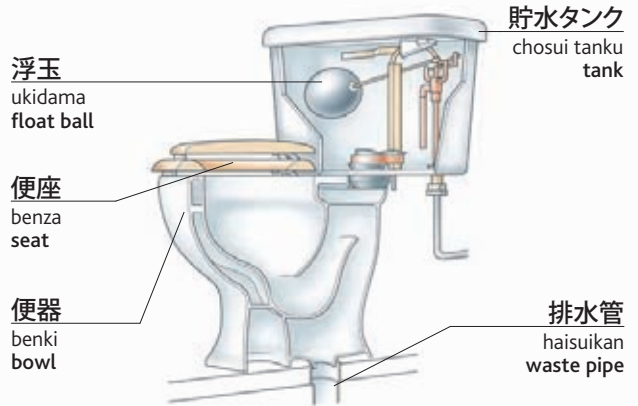

# ゴミ処理 gomishori • waste disposal



# 居間 ima • living room



絵  
e  
painting

額縁  
gakubuchi  
frame

ランプ  
rampu  
lamp

壁面照明  
hekimen shōmei  
wall light

時計  
tokei  
clock

天井  
tenjō  
ceiling

食器棚  
shokkidana  
cabinet

ソファ  
sofa  
sofa

クッション  
kushshon  
cushion

コーヒーテーブル  
kōhī tēburu  
coffee table

床  
yuka  
floor



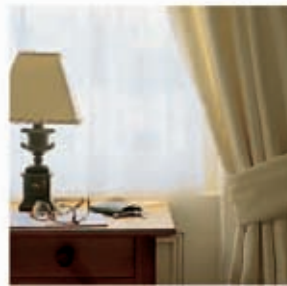

カーテン  
kāten  
curtain



メッシュカーテン  
messhu kāten  
sheer curtain



ベネシャンブラインド  
beneshan buraindo  
venetian blind



ロールスクリーン  
rōru sukurīn  
window shade

モールディング  
mōrudingu  
molding

アームチェア  
āmuccha  
armchair



書斎 shosai | study

# ダイニングルーム dainingu rūmu • dining room



## 関連用語 kanrenyōgo • vocabulary

給仕する  
kyūji suru  
serve (v)

朝食  
chōshoku  
breakfast

満腹  
mampuku  
full

箸  
hashi  
chopsticks

食べる  
taberu  
eat (v)

昼食  
chūshoku  
lunch

一人分  
hitoribun  
one portion

ご飯茶碗  
gohan-jawan  
rice bowl

空腹  
kūfuku  
hungry

夕食  
yūshoku  
dinner

食事  
shokuji  
meal

茶碗  
chawan  
(Japanese) teacup

テーブルクロス  
tēburukurosu  
tablecloth

ランチョンマット  
ranchon matto  
placemat

客  
kyaku  
guest

座布団  
zabuton  
(Japanese) floor cushion

おかわりできますか。  
okawari dekimasuka?  
May I have some more, please?

もう結構です。  
mō kekkō desu.  
I've had enough, thank you.

美味しかったです。  
oishikatta desu.  
That was delicious.

食器類 shokki rui • dishes and utensils



マグカップ  
magu kappu  
mug



コーヒーカップ  
kōhikappu  
coffee cup



ティーカップ  
tikappu  
teacup

ティースプーン  
tisupūn  
teaspoon



皿  
sara  
plate



ボウル  
bōru  
bowl



カフェプレス  
kafe puresu  
cafetière



ティーポット  
tipotto  
teapot



水差し  
mizusashi  
pitcher



エッグカップ  
eggu kappu  
egg cup

ワイングラス  
waingurasu  
wine glass



タンブラー  
tamburā  
tumbler

コップ類  
koppu rui  
glassware

ナプキンリング  
napukin ringu  
napkin ring

小皿  
kozara  
side plate

大皿  
ōzara  
dinner plate

スープ皿  
sūpuzara  
soup bowl

スプーン  
sūpusupūn  
soup spoon



ナプキン  
napukin  
napkin

フォーク  
fōku  
fork

テーブル・セッティング  
tēburu settingu  
place setting

スプーン  
supūn  
spoon

ナイフ  
naifu  
knife



# 台所 daidokoro • kitchen



# 電気器具 denki kigu • appliances



製氷室  
seihyōshitsu  
icemaker

冷凍庫  
reitōko  
freezer



冷蔵庫  
reizōko  
refrigerator

棚  
tana  
shelf

野菜室  
yasai-shitsu  
crisper

冷凍冷蔵庫 reitōreizōko |refrigerator-freezer

関連用語 kanrenyōgo  
• vocabulary

水切り台  
mizukiridai  
drainboard

ガスレンジ  
gasurenji  
burner

コンロ  
konro  
stovetop

ゴミ箱  
gomibako  
garbage can

冷凍する  
reitō suru  
freeze (v)

解凍する  
kaitō suru  
defrost (v)

蒸す  
musu  
steam (v)

炒める  
itameru  
sauté (v)

調理 chōri • cooking



皮を剥く  
kawa o muku  
peel (v)



切る  
kiru  
slice (v)



すり下ろす  
suriorosu  
grate (v)



注ぐ  
sosogu  
pour (v)



混ぜる  
mazeru  
mix (v)



泡立てる  
awadateru  
whisk (v)



茹でる  
yuderu  
boil (v)



揚げる  
ageru  
fry (v)



巻く  
maku  
roll (v)



かき回す  
kakimawasu  
stir (v)



煮込む  
nikomu  
simmer (v)



(沸騰前の温度で) 茹でる  
(futtō mae no ondo de) yuderu  
poach (v)



(オーブンで) 焼く  
(ōbun de) yaku  
bake (v)



ローストする  
rōsuto suru  
roast (v)



焼く  
yaku  
grill (v)

# 調理用具 chōri yōgu • kitchenware



まな板  
manaïta  
chopping block

ブレッドナイフ  
bureddo naifu  
bread knife



包丁  
hōchō  
kitchen knife



肉切り包丁  
nikukiribōchō  
cleaver



包丁研ぎ器  
hōchō togi-ki  
knife sharpener



肉たたき  
nikutataki  
meat tenderizer



串  
kushi  
skewer



卸し金  
oroshigane  
grater



すり粉木  
surikogi  
pestle



ポテトマッシャー  
poteto masshā  
masher



皮むき器  
kawamuki-ki  
peeler



リンゴの芯抜き器  
ringo no shin nuki-ki  
apple corer



缶切り  
kankiri  
can opener



栓抜き  
sennuki  
bottle opener



ガーリックプレス  
gārikku puresu  
garlic press



給仕用スプーン  
kyūji-yō supūn  
serving spoon



フライ返し  
furaigaeshi  
spatula



水切りざる  
mizukiri zaru  
colander



へら  
hera  
spatula



木製スプーン  
mokusei supūn  
wooden spoon



穴あきスプーン  
ana'aki supūn  
slotted spoon



おたま  
otama  
ladle



カービングフォーク  
kābingu fōku  
carving fork



アイスクリーム・スクープ  
aisukurīmu sukūpu  
scoop



泡立て器  
awadaketi  
whisk



ストレーナー  
sutorēnā  
strainer





## ケーキ作り kēki-zukuri • baking cakes



# 寝室 shinshitsu • bedroom

洋服ダンス

yōfukudansu  
wardrobe

ベッドサイドランプ

beddosaido rampu  
bedside lamp

ヘッドボード

heddobōdo  
headboard

ベッドサイドテーブル

beddosaido tēburu  
bedside table

ダンス

tansu  
chest of drawers



引き出し

hikidashi  
drawer

ベッド

beddo  
bed

マットレス

mattoresu  
mattress

ベッドカバー

beddokabā  
bedspread

枕

makura  
pillow



湯たんぽ  
yutampo  
hot-water bottle



時計付きラジオ  
tokei-tsuki rajio  
clock radio



目覚まし時計  
mezamashi-dokei  
alarm clock



ティッシュの箱  
tissu no hako  
box of tissues



ハンガー  
hangā  
coat hanger

ベッド beddo • bed



鏡  
kagami  
mirror

化粧台  
keshōdai  
dressing table

床  
yuka  
floor



枕カバー  
makurakabā  
pillowcase

シーツ  
shītsu  
sheet

ベッドスカート  
beddo sukāto  
dust ruffle

羽布団  
hanebuton  
comforter

キルト  
kiruto  
quilt

毛布  
mōfu  
blanket



関連用語 kanrenyōgo • vocabulary

シングルベッド  
shinguru beddo  
twin bed

フットボード  
futtobōdo  
footboard

不眠症  
fuminshō  
insomnia

目覚める  
mezameru  
wake up (v)

目覚ましをかける  
mezamashi o kakeru  
set the alarm (v)

ダブルベッド  
daburu beddo  
full bed

スプリング  
supuringu  
spring

床につく  
toko ni tsuku  
go to bed (v)

起きる  
okiru  
get up (v)

鼾をかく  
ibiki o kaku  
snore (v)

布団  
futon  
comforter

カーペット  
kāpetto  
carpet

寝る  
neru  
go to sleep (v)

ベッドメイキングする  
beddomēkingu suru  
make the bed (v)

電気毛布  
denkimōfu  
electric blanket



# 浴室 yokushitsu • bathroom

タオル掛け  
taorukake  
towel rack

シャワードア  
shawā doa  
shower door

冷水タップ  
reisui tappu  
cold faucet

温水タップ  
onsui tappu  
hot faucet

シャワーヘッド  
shawāheddo  
shower head

流し台  
nagashidai  
sink

栓  
sen  
plug



浴槽  
yokusō  
bathtub



ビデ bide | bidet



シャワー  
shawā  
showerstall

排水口  
haisuikō  
drain

便座  
benza  
toilet seat

便器  
benki  
toilet

トイレブラシ  
toire burashi  
toilet brush

## 関連用語 kanrenyōgo • vocabulary

浴室用キャビネット  
yokushitsu-yō kyabinetto  
medicine cabinet

バスマット  
basu matto  
bath mat

トイレトペーパー  
toiretto pēpā  
toilet paper

シャワーカーテン  
shawā kāten  
shower curtain

シャワーを浴びる  
shawā o abiru  
take a shower (v)

風呂に入る  
furo ni hairu  
take a bath (v)

## 歯の手入れ ha no teire • dental hygiene



歯ブラシ  
haburashi  
toothbrush



歯磨き粉  
hamigakiko  
toothpaste



マウスウォッシュ  
mausu wosshu  
mouthwash

デンタルフロス  
dentaru furosu  
dental floss





ヘチマ  
hechima  
loofah

スポンジ  
sponji  
sponge



軽石  
karuishi  
pumice stone



背中洗いブラシ  
senaka arai burashi  
back brush



デオドラント  
deodoranto  
deodorant

石鹸皿  
sekken-zara  
soap dish



石鹸  
sekken  
soap

シャワージェル  
shawā jeru  
shower gel



フェースクリーム  
fēsu kurīmu  
face cream



バブルバス  
baburu basu  
bubble bath



バスローブ  
basurōbu  
bathrobe

ハンドタオル  
hando taoru  
hand towel



タオル  
taoru  
towels

バスタオル  
basu taoru  
bath towel



ボディローション  
bodi rōshon  
body lotion



タルカムパウダー  
tarukamu paudā  
talcum powder

## 髭剃り higesori • shaving



電気剃刀  
denki kamisori  
electric razor



髭剃りクリーム  
higesori kurīmu  
shaving cream



使い捨てカミソリ  
tsukaisute kamisori  
disposable razor



カミソリの刃  
kamisori no ha  
razor blade



アフターシェーブ  
afutāshēbu  
aftershave

# 子供部屋 kodomobeya • nursery

## ベビーケア bebī kea • baby care



スポンジ  
suponji  
sponge

オムツかぶれクリーム  
omutsu kabure kurīmu  
diaper rash cream

ベビーバス  
bebī basu  
baby bath



おしり拭き  
oshiri fuki  
wet wipe

おまる  
omaru  
potty



おむつ替えシート  
omutsu kae shīto  
changing mat

## 睡眠 suimin • sleeping

モバイル  
mobīru  
mobile



マットレス  
mattoresu  
mattress  
ベビーベッド bebībeddo | crib

シーツ  
shītsu  
sheet

毛布  
mōfu  
blanket

柵  
saku  
bars

フリース  
furīsu  
fleece

ベッドバンパー  
beddo bampā  
bumper



ガラガラ  
garagara  
rattle



寝具  
shingu  
bedding



新生児用かご型ベッド  
shinseiji-yō kago-gata beddo  
bassinets



遊び asobi • playing



人形  
ningyō  
doll

縫いぐるみ  
nuigurumi  
soft toy



ドールハウス  
dōru hausu  
dollhouse



子供の家  
kodomo no ie  
playhouse

安全用品  
anzen yōhin  
• safety

戸棚ロック  
todana rokkū  
child lock



ベビーモニター  
bebī monitā  
baby monitor



ベビーゲート  
bebī gēto  
stair gate



おもちゃ籠  
omocha kago  
toy basket

テディベア  
tedibea  
teddy bear

おもちゃ  
omocha  
toy



ベビーサークル  
bebīsākuru  
playpen

ボール  
bōru  
ball

食事 shokuji  
• eating



ハイチェア  
haichea  
high chair

乳首  
chikubi  
nipple

ベビー用マグカップ  
bebī-yō magu kappu  
drinking cup



哺乳瓶  
honyūbin  
bottle

外出 gaishutsu • going out



ベビーカー  
bebīkā  
stroller



乳母車  
ubaguruma  
baby carriage

フード  
fūdo  
hood



キャリーコット  
kyarīkotto  
infant carrier



おむつ替えバッグ  
omutsu kae baggu  
diaper bag

おむつ  
omutsu  
diaper



ベビースリング  
bebī suringu  
baby sling

# ユティリティールーム yutiriti rūmu • utility room

## 洗濯 sentaku • laundry

汚れ物  
yogoremono  
dirty washing



洗濯物入れ  
sentakumono ire  
laundry basket



洗濯機  
sentakki  
washing machine



洗濯乾燥機  
sentaku kansōki  
washer-dryer



乾燥機  
kansōki  
tumble dryer

洗濯物  
sentakumono  
clean clothes



洗濯かご  
sentakukago  
laundry basket

洗濯バサミ  
sentaku-basami  
clothes pin



乾かす  
kawakasu  
dry (v)

物干用ロープ  
monohoshi-yō rōpu  
clothesline



アイロン台 airon dai | ironing board



アイロン  
airon  
iron

### 関連用語 kanrenyōgo • vocabulary

(汚れ物を洗濯機に) 入れる  
(yogoremono o sentakki ni) ireru  
load (v)

濯ぐ  
susugu  
rinse (v)

脱水する  
dassui suru  
spin (v)

脱水機  
dassuiki  
spin dryer

アイロンをかける  
airon o kakeru  
iron (v)

柔軟仕上げ剤  
jūnan shiagezai  
fabric softener

この洗濯機は、どうやって使うのですか。  
kono sentakki wa dōyatte tsukaunodesuka?  
How do I operate the washing machine?

色物／白系の設定は何ですか。  
iromono/shirokei no settei wa nandesuka?  
What is the setting for colors/whites?

## 掃除道具 sōji dōgu • cleaning equipment



## 掃除 sōji • activities



擦る  
kosuru  
clean (v)



洗う  
arau  
wash (v)



拭く  
fuku  
wipe (v)



ゴシゴシ洗う  
goshigoshi arau  
scrub (v)



擦り取る  
kosuritoru  
scrape (v)



箒  
hōki  
broom

掃く  
haku  
sweep (v)



埃を払う  
hokori o harau  
dust (v)



磨く  
migaku  
polish (v)



# 作業場 sagyōba • workshop



ジグソー  
jigusō  
jigsaw



電池パック  
denchi paku  
battery pack



チャック  
chakku  
chuck

ドリルビット  
doriru bitto  
drill bit



グルーガン  
gurū gan  
glue gun



万力  
manriki  
vice



クランプ  
kurampu  
clamp

サンダー  
sandā  
sander

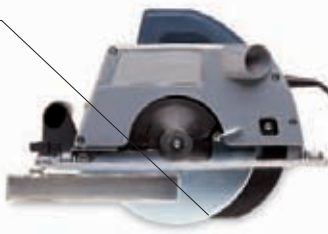

鋸刃  
nokogiri-ba  
blade

丸鋸  
marunoko  
circular saw



作業台  
sagyōdai  
workbench

木工用接着剤  
mokkō-yō setchakuzai  
wood glue

ルーター  
rūtā  
router

鉋屑  
kannakuzu  
wood shavings



工具棚  
kōgu-dana  
tool rack

ハンドドリル  
hando doriru  
bit brace

延長コード  
enchō kōdo  
extension cord

## テクニック tekunikku • techniques



切る  
kuru  
cut (v)



(鋸で) 切る  
(nokogiri de) kuru  
saw (v)



穴をあける  
ana o akeru  
drill (v)



(金槌で) 打つ  
(kanazuchi de) utsu  
hammer (v)



鉋をかける  
kanna o kakeru  
plane (v)



旋盤加工する  
sembankō suru | turn (v)



半田  
handa  
solder  
  
削る  
kezuru | carve (v)



半田付ける  
handazuke suru | solder (v)

## 材料 zairyō • materials

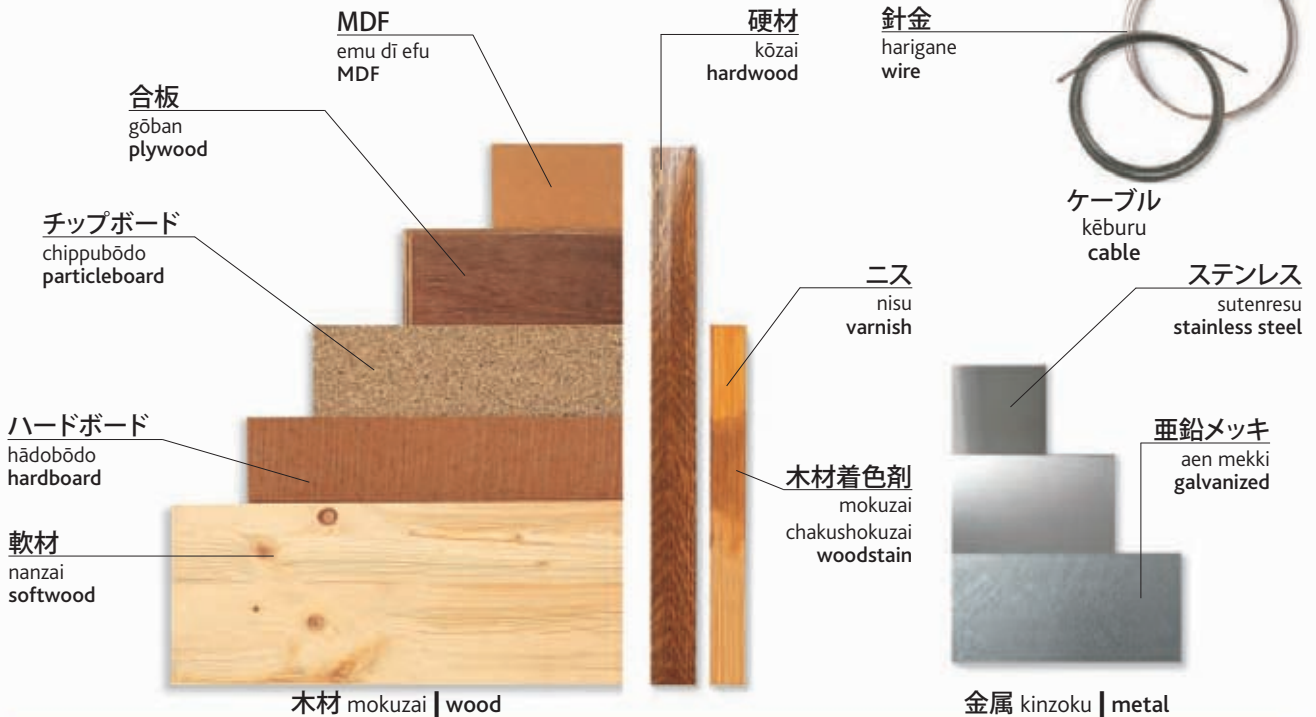

# 工具箱 dōgubako • toolbox

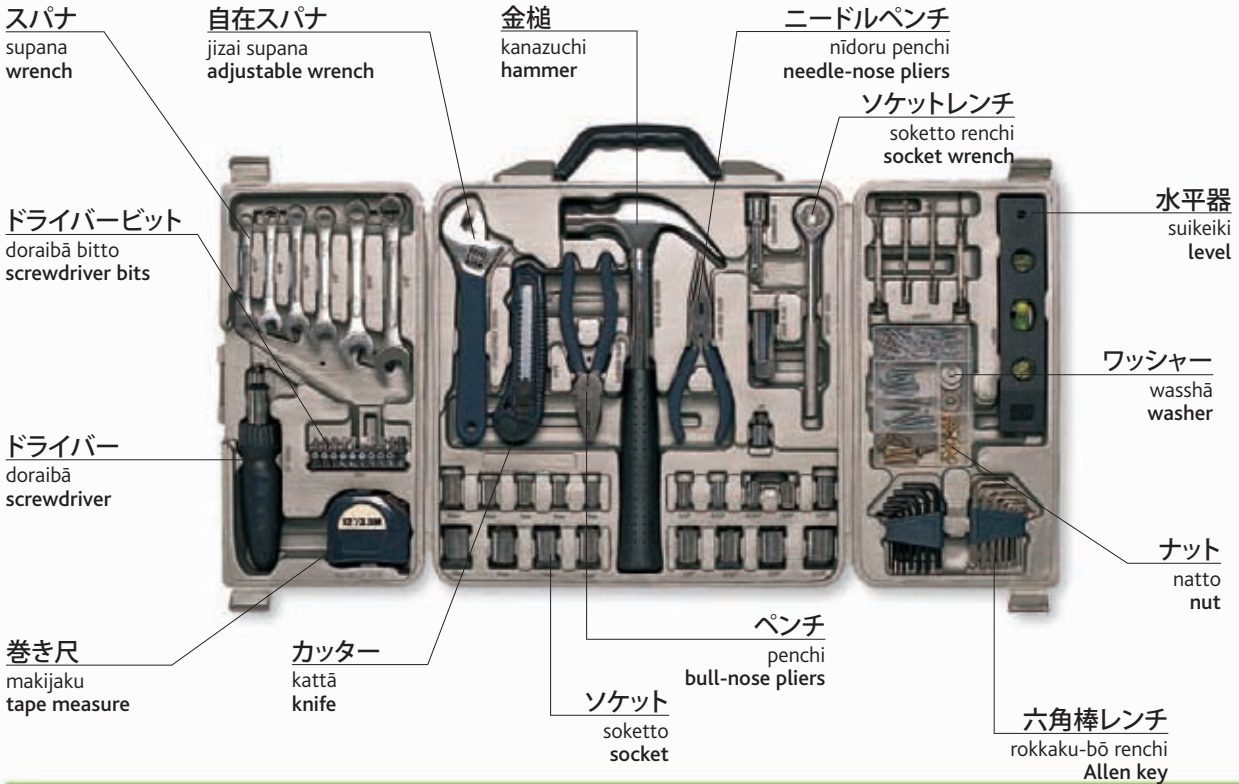

# ドリルビット doriru bitto • drill bits

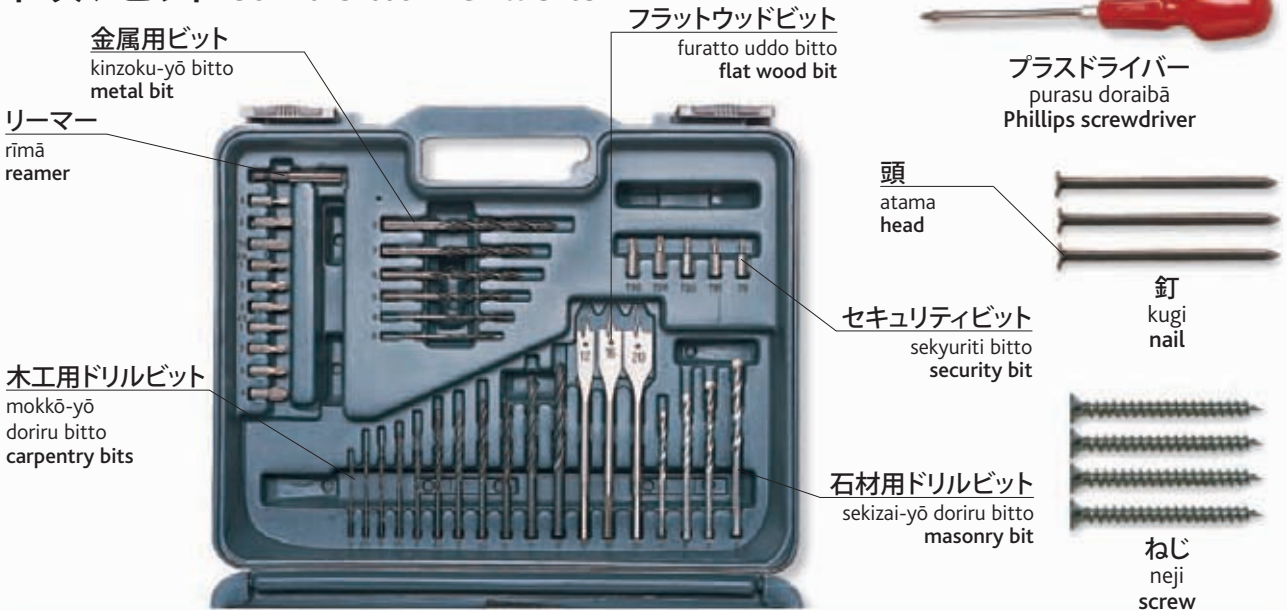



ワイヤーストリッパー  
waiyā sutorippā  
wire strippers

ワイヤーカッター  
waiyā kattā  
wire cutters

半田ごて  
handagote  
soldering iron

絶縁テープ  
zetsuen tēpu  
electrical tape



カッターナイフ  
kattā naifu  
scalpel

糸鋸  
itonoko  
fretsaw

半田  
handa  
solder



保護めがね  
hogo megane  
safety goggles



鉋  
kanna  
plane



胴付き鋸 dōtsuki noko | tenon saw



手引き鋸  
tebiki noko  
handsaw



ハンドドリル  
hand odoriru  
hand drill



スチールウール  
suchīru'ūru  
steel wool



マイターボックス  
maitā bokkusu  
miter block



弓鋸  
yuminoko  
hacksaw



紙やすり  
kami yasuri  
sandpaper

レンチ  
renchi  
wrench



鑿  
nomi  
chisel



砥石  
toishi  
sharpening stone



やすり  
yasuri  
file



吸引カップ  
kyūin kappu  
plunger



パイプカッター paipu kattā | pipe cutter



# 内装工事 naisō kōji • decorating



鋏  
hasami  
scissors



クラフトナイフ  
kurafuto naifu  
utility knife



下げ振り  
sagefuri  
plumb line



スクレーパー  
sukurēpā  
scraper

内装工事職人  
naisō kōji shokunin  
decorator

壁紙  
kabegami  
wallpaper

脚立  
kyatatsu  
stepladder



壁紙刷毛  
kabegami-bake  
wallpaper brush

糊付け台  
nori-zuke dai  
pasting table

糊刷毛  
noribake  
pasting brush

壁紙用糊  
kabegami-yō nori  
wallpaper paste

バケツ  
baketsu  
bucket

壁紙を張り替える kabegami o harikaeru | wallpaper (v)



剥がす hagasu | strip (v)



埋める umeru | fill (v)



研磨する kenma suru | sand (v)



漆喰を塗る shikkui o nuru | plaster (v)



壁紙を貼る kabegami o haru | hang (v)



タイルを貼る tairu o haru | tile (v)



ローラー  
rōrā  
roller



ローラー受け皿  
rōrā ukezara  
paint tray



ペンキ  
penki  
paint

刷毛  
hake  
brush



スポンジ  
suponji  
sponge



マスキングテープ  
masukingu tēpu  
masking tape



サンドペーパー  
sandopēpā  
sandpaper

塗料バケツ  
toryō baketsu  
paint can

つなぎ  
tsunagi  
overalls

養生シート  
yōjō shīto  
drop cloth



テレピン油  
terepin-yu  
turpentine



塗料用シンナー  
toryō-yō shinnā  
paint thinner

充填剤  
jūtenzai  
filler

塗装する tosō suru | paint (v)

関連用語 kanrenyōgo • vocabulary

漆喰  
shikkui  
plaster

艶出し  
tsuyadashi  
gloss

エンボス壁紙  
embosu kabegami  
embossed paper

下塗り  
shitanuri  
undercoat

シーラー  
shīrā  
sealant

ニス  
nisu  
varnish

艶消し  
tsuyakeshi  
mat

裏打ち紙  
urauchi-gami  
lining paper

上塗り  
uwanuri  
top coat

溶剤  
yōzai  
solvent

エマルション  
emarushon  
emulsion

ステンシル  
sutenshiru  
stencil

プライマー  
puraimā  
primer

防腐剤  
bōfuzai  
preservative

グラウト  
gurauto  
grout



# 庭 niwa • garden

## 庭の様式 niwa no yōshiki • garden styles



テラスガーデン terasu gāden | patio garden



フォーマルな庭園 fōmaru-na teien | formal garden



コテージガーデン  
kotēji gāden  
cottage garden



ハーブ園  
hābu-en  
herb garden



屋上庭園  
okujō teien  
roof garden



石庭  
sekitei  
rock garden



中庭 nakaniwa | courtyard



ウォーターガーデン  
wōtā gāden  
water garden

## 庭のアクセント niwa no akusento • garden features



ハンギングバスケット  
hangingu basuketto  
hanging basket



トレリス torerisu | trellis



パーゴラ  
pāgora  
arbor



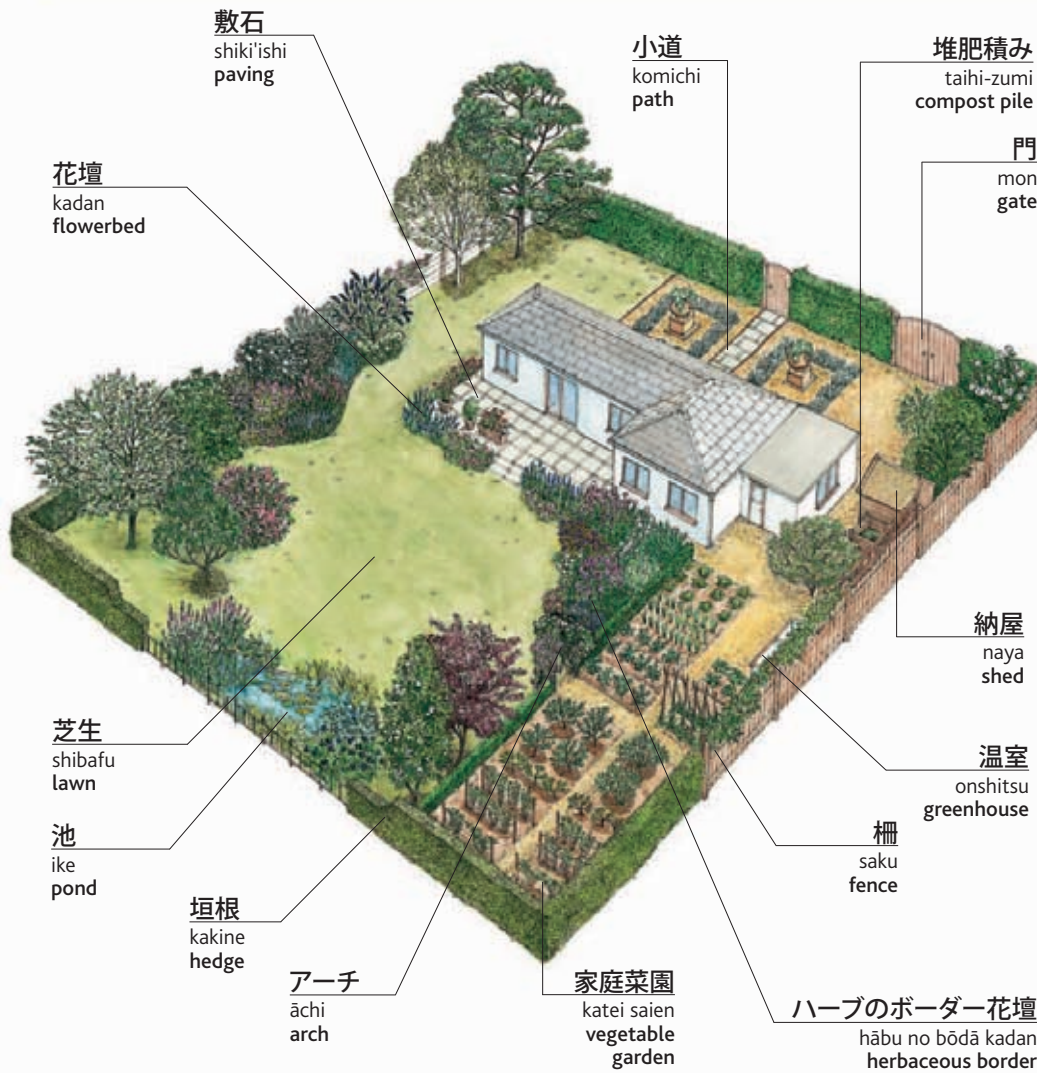

## 土壌 dojō

• soil



表土  
hyōdo  
topsoil



砂土  
sunatsuchi  
sand



石灰質土壌  
sekkai-shitsu dojō  
chalk



沈泥  
chindei  
silt



粘土  
nendo  
clay



デッキ  
dekki  
deck



噴水 funsui | fountain

# 庭の植物 niwa no shokubutsu • garden plants

## 植物の種類 shokubutsu no shurui • types of plants



一年草  
ichinensō  
annual



二年草  
ninensō  
biennial



多年草  
tanensō  
perennial



球根植物  
kyūkon shokubutsu  
bulb



シダ  
shida  
fern



い草  
igusa  
rush



竹  
take  
bamboo



雑草  
zassō  
weed



ハーブ  
hābu  
herb



水草  
mizukusa  
water plant



木  
ki  
tree



落葉樹  
rakuyōju  
deciduous



椰子の木  
yashi no ki  
palm



針葉樹  
shin'yōju  
conifer



常緑樹  
jōryokuju  
evergreen





トピアリー  
topiārī  
topiary



高山植物  
kōzan shokubutsu  
alpine



多肉植物  
taniku shokubutsu  
succulent



サボテン  
saboten  
cactus

植木  
ueki  
potted plant

陰性植物  
insei shokubutsu  
shade plant

蔓性植物  
tsurusei shokubutsu  
climber

顕花性低木  
kenkasei teiboku  
flowering shrub

グランドカバー  
gurando kabā  
ground cover



匍匐植物  
hofuku shokubutsu  
creeper

観葉植物  
kan'yō  
shokubutsu  
ornamental

草  
kusa  
grass

# 園芸用品 engei yōhin • garden tools



ショベル  
shoiberu  
spade



フォーク  
fōku  
fork



雑草刈り鋏  
zassō kari-basami  
long-handled shears



レーキ  
rēki  
rake



鍬  
kuwa  
hoe



堆肥  
taihi  
compost



種  
tane  
seeds



骨粉  
kotsufun  
bone meal



砂利  
jari  
gravel



集草バッグ  
shūsō baggu  
grass bag

モーター  
mōtā  
motor

取っ手  
totte  
handle

シールド  
shirudo  
shield

トリマー  
torimā  
trimmer

芝刈り機  
shibakariki  
lawnmower



トラグ  
toragu  
trug



スタンド  
sutando  
stand

一輪台車  
ichirin daisha  
wheelbarrow





ハンドフォーク  
hando fōku  
hand fork



剪定鋏  
sentei-basami  
pruners

園芸用手袋  
engi-yō tebukuro  
gardening gloves



スコップ  
sukoppu  
trowel



種蒔きトレイ  
tanemaki torei  
seed tray

結束紐  
kessoku himo  
twine

ラベル  
raberu  
labels

刃  
ha  
blade



刈り込み鋏  
karikomi-basami  
shears



殺虫剤  
satchūzai  
pesticide



支え棒  
sasaebō  
stakes

ビニールタイ  
binīru tai  
twist ties

リングタイ  
ringu tai  
ring ties



剪定鋸  
sentei noko  
hand saw



篩  
furui  
sieve

植木鉢  
uekibachi  
plant pot



ゴム長靴  
gomunagagutsu  
rubber boots

## 水やり mizuyari • watering



霧吹き kirifuki | spray gun



スプリンクラー  
supurinkurā  
sprinkler

ノズル  
nozuru  
nozzle

じょうろ  
jōro  
watering can

ホース  
hōsu  
hosepipe

薔薇  
bara  
rose



ホースリール hōsu rīru | hose reel



# 園芸 engei • gardening

芝生  
shibafu  
lawn

花壇  
kadan  
flowerbed

芝刈り機  
shibakariki  
lawnmower



垣根  
kakine  
hedge

杭  
kui  
stake

芝刈りする shibakari suru | mow (v)



芝で覆う  
shiba de ōu  
sod (v)



刺す  
sasu  
spike (v)



掃く  
haku  
rake (v)



刈り込む  
karikomu  
trim (v)



掘る  
horu  
dig (v)



種を植える  
tane o ueru  
sow (v)



追肥する  
tsuihi suru  
top-dress (v)



水をやる  
mizu o yaru  
water (v)



整枝する  
seishi suru  
train (v)



(終わった花を) 摘み取る  
(owatta hana o) tsumitoru  
deadhead (v)

噴霧する  
funmu suru  
spray (v)



支え棒  
sasaebō  
stake



接ぎ木する  
tsugiki suru  
graft (v)



切り枝  
kirieda  
cutting



剪定する  
sentei suru  
prune (v)

(支えに) 繋ぐ  
(sasaeni) tsunagu  
stake (v)



植え替える  
ue-kaeru  
transplant (v)



除草する  
josō suru  
weed (v)



根覆いする  
neōi suru  
mulch (v)



収穫する  
shūkaku suru  
harvest (v)

関連用語 kanrenyōgo • vocabulary

栽培する  
saibai suru  
cultivate (v)

造園する  
zōen suru  
landscape (v)

肥料をやる  
hiryō o yaru  
fertilize (v)

篩にかける  
furui ni kakeru  
sieve (v)

有機  
yūki  
organic

苗  
nae  
seedling

心土  
shindo  
subsoil

手入れする  
teire suru  
tend (v)

(大きな鉢に) 植え替える  
(ōkina hachi ni) ue-kaeru  
pot up (v)

摘む  
tsumu  
pick (v)

空気に曝す  
kūki ni sarasu  
aerate (v)

排水  
haisui  
drainage

肥料  
hiryō  
fertilizer

除草剤  
josōzai  
weedkiller







職務 shokumu  
services

# 緊急サービス kinkyū sābisu • emergency services

## 救急車 kyūkyūsha • ambulance



救急車 kyūkyūsha | ambulance



救急医療隊員 kyūkyū iryō tai'in  
paramedic

担架  
tanka  
stretcher

## 警察 keisatsu • police



バッジ  
bajji  
badge

制服  
seifuku  
uniform

サイレン  
sairin  
siren

警光灯  
keikōtō  
lights



パトカー  
patokā  
police car



警察署  
keisatsusho  
police station

警棒  
keibō  
nightstick



手錠  
tejō  
handcuffs

拳銃  
kenjū  
gun

警官 keikan | police officer

### 関連用語 kanrenyōgo • vocabulary

警部  
keibu  
lieutenant

容疑者  
yōgisha  
suspect

申し立て  
mōshitate  
complaint

逮捕  
taiho  
arrest

犯罪  
hanzai  
crime

暴行  
bōkō  
assault

調査  
chōsa  
investigation

留置場  
ryūchijō  
jail cell

刑事  
keiji  
detective

指紋  
shimon  
fingerprint

押し込み強盗  
oshikomi gōtō  
burglary

告訴  
kokuso  
charge

# 消防隊 shōbōtai • fire department



火事 kaji | fire

煙

kemuri  
smoke

ヘルメット

herumetto  
helmet

ホース

hōsu  
hose

バスケット

basuketto  
cradle

水ジェット

mizu jetto  
water jet

消防士  
shōbōshi  
firefighters

腕

ude  
boom

梯子

hashigo  
ladder

運転台

untendai  
cab



消防署  
shōbōsho  
fire station



非常階段  
hijō kaidan  
fire escape



消防車  
shōbōsha  
fire engine



煙報知器  
kemuri hōchiki  
smoke alarm



火災警報機  
kasai keihōki  
fire alarm



防災斧  
bōsai ono  
ax



消火器  
shōkaki  
fire extinguisher



消火栓  
shōkasen  
hydrant

警察／消防車／救急車が必要です。  
keisatsu/shōbōsha/kyūkyūsha ga hitsuyō  
desu.  
I need the police/fire department/  
ambulance.

...で火が出ています。  
... de hi ga dete imasu.  
There's a fire at...

事故がありました。  
jiko ga arimashita.  
There's been an accident.

警察を呼んでください。  
keisatsu o yonde kudasai!  
Call the police!



# 銀行 ginkō • bank

客  
kyaku  
customer

窓口  
madoguchi  
window

出納係  
suitō-gakari  
cashier



リーフレット  
rifuretto  
brochures

カウンター  
kauntā  
counter

入金書  
nyūkin-sho  
deposit slips

デビットカード  
debitto kādo  
debit card

半券  
hanken  
stub

口座番号  
kōza bangō  
account number

署名  
shomei  
signature

金額  
kingaku  
amount



支店長  
shitenchō  
bank manager



クレジットカード  
kurejitto kādo  
credit card



小切手帳  
kogitte-chō  
checkbook

小切手  
kogitte  
check

## 関連用語 kanrenyōgo • vocabulary

貯金  
chokin  
savings

住宅ローン  
jūtaku rōn  
mortgage

支払い  
shiharai  
payment

入金する  
nyūkin suru  
deposit (v)

当座預金口座  
tōzayokin kōza  
checking account

税  
zei  
tax

超過引き出し  
chōka hikidashi  
overdraft

自動引き落とし  
jidō hikiotoshi  
automatic payment

銀行手数料  
ginkō tesūryō  
fee

普通預金口座  
futsūyokin kōza  
savings account

ローン  
rōn  
loan

金利  
kinri  
interest rate

出金依頼書  
shukkin irai-sho  
withdrawal slip

銀行振込  
ginkō furikomi  
electronic transfer

暗証番号  
anshō bangō  
PIN

硬貨  
kōka  
coin



金銭 kinsen | money

紙幣  
shihei  
bill

画面  
gamen  
screen

キーパッド  
kipaddo  
keypad



ATM ē tī emu | ATM

カード挿入口  
kādo sōnyū-guchi  
card slot

## 外貨 gaika • foreign currency



両替所  
ryōgaejo  
bureau de change



旅行小切手  
ryokō kogitte  
traveler's check



換算率  
kansan ritsu  
exchange rate

## 関連用語 kanrenyōgo • vocabulary

換金する  
kankin suru  
cash (v)

株  
kabu  
shares

額面金額  
gakumen kingaku  
denomination

配当  
haitō  
dividends

手数料  
tesuryō  
commission

会計士  
kaikeishi  
accountant

投資  
tōshi  
investment

ポートフォリオ  
pōtoforio  
portfolio

株式  
kabushiki  
stocks

エクイティ  
ekuiti  
equity

## 金融 kin'yū • finance

株価  
kabuka  
share price



金融アドバイザー  
kin'yū adobaizā  
financial advisor

ブローカー  
burōkā  
stockbroker



証券取引所 shōken torihiki-jo  
stock exchange

これを両替できますか。  
kore o ryōgae dekimasuka?  
May I change this please?

今日の換算率は何ですか。  
kyō no kansan ritsu wa nandesuka?  
What is today's exchange rate?

# コミュニケーション komyunikēshon • communications

郵便局員  
yūbinkyoku-in  
postal worker

窓口  
madoguchi  
window

秤  
hakari  
scale

カウンター  
kauntā  
counter



郵便局 yūbinkyoku | post office

消印  
keshi'in  
postmark

切手  
kitte  
stamp

住所  
jūsho  
address

郵便番号  
yūbim-bangō  
ZIP code



封筒 fūtō | envelope



郵便配達人  
yūbin haitatsunin  
mail carrier

## 関連用語 kanrenyōgo • vocabulary

手紙  
tegami  
letter

差出人住所  
sashidashinin jūsho  
return address

配達  
haitatsu  
delivery

壊れ物  
kowaremono  
fragile

折曲厳禁  
orimage genkin  
do not bend (v)

航空便  
kōkūbin  
by airmail

署名  
shomei  
signature

郵便為替  
yūbin kawase  
money order

郵便袋  
yūbim-bukuro  
mailbag

こちらが上  
kochira ga ue  
this way up

書留郵便  
kakitome yūbin  
registered mail

集荷  
shūka  
pickup

郵送料  
yūsō-ryō  
postage

電報  
dempō  
telegram

ファクス  
fakusu  
fax





郵便ポスト  
yūbin posuto  
mailbox



郵便受け  
yūbin-uke  
letter slot



小包  
kozutsumi  
package



宅配  
takuhai  
courier

## 電話 denwa • telephone

受話器  
juwaki  
handset

ベース  
bēsu  
base station



コードレス電話  
kōdoresu denwa  
cordless phone

留守番電話  
rusuban denwa  
answering machine



ビデオ電話  
bideo denwa  
video phone



公衆電話ボックス  
kōshū-denwa bokkusu  
telephone box



携帯電話  
keitai denwa  
cell phone

キーパッド  
kīpaddo  
keypad

受話器  
juwaki  
receiver

おつり  
otsuri  
coin return



硬貨式公衆電話  
kōka-shiki kōshū-denwa  
coin phone



カード式公衆電話  
kādo-shiki kōshū-denwa  
card phone

## 関連用語 kanrenyōgo • vocabulary

番号案内  
bangō annai  
directory assistance

電話に出る  
denwa ni deru  
answer (v)

交換手  
kōkanshu  
operator

...の電話番号を教えてください。  
... no denwa bangō o oshiete kudasai.  
Please give me the number for...

コレクトコール  
korekuto kōru  
collect call

携帯メール  
keitai mēru  
text message

通話中  
tsūwa-chū  
busy

...の局番は何ですか。  
... no kyokuban wa nandesuka?  
What is the area code for...?

電話する  
denwa suru  
dial (v)

音声メッセージ  
onsei messēji  
voice message

不通  
futsū  
disconnected

# ホテル hoteru • hotel

## ロビー robī • lobby

宿泊客  
shukuhaku kyaku  
guest

部屋の鍵  
heya no kagi  
room key

メッセージ  
messēji  
messages

分類棚  
bunrui-dana  
pigeonhole

フロント係  
furonto-gakari  
receptionist

宿泊者名簿  
shukuhaku-  
sha meibo  
register

カウンター  
kauntā  
counter



フロント furonto | reception



荷物  
nimotsu  
luggage

カート  
kāto  
cart

ポーター pōtā | porter



エレベーター erebētā | elevator



部屋番号  
heya bangō  
room number

## 客室 kyakushitsu • rooms



シングルルーム  
shinguru rūmu  
single room

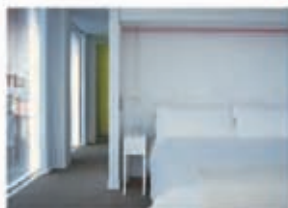

ダブルルーム  
daburu rūmu  
double room



ツインルーム  
tsuin rūmu  
twin room



客室付きバスルーム  
kyakushitsu-zuki basurūmu  
private bathroom

## 職務 shokumu • services



掃除サービス  
sōji sābisu  
maid service



洗濯サービス  
sentaku sābisu  
laundry service

朝食トレイ  
chōshoku torei  
breakfast tray



ルームサービス rūmu sābisu | room service



ミニバー  
minibā  
minibar



レストラン  
restoran  
restaurant



ジム  
jimu  
gym



プール  
pūru  
swimming pool

## 関連用語 kanrenyōgo • vocabulary

朝食付き  
chōshoku-tsuki  
bed and breakfast

3食付き  
sanshoku-tsuki  
all meals included

2食付き  
nishoku-tsuki  
some meals included

空室はありますか。  
kūshitsu wa arimasuka?  
Do you have any vacancies?

予約してあります。  
yoyaku shite arimasu.  
I have a reservation.

シングルルームをお願いします。  
shinguru rūmu o onegai shimasu.  
I'd like a single room.

3泊お願いします。  
sampaku onegai shimasu.  
I'd like a room for three nights.

一泊いくらですか。  
ippaku ikura desuka?  
What is the charge per night?

チェックアウトは何時ですか。  
chekkuauto wa nanji desuka?  
When do I have to vacate the room?









買い物 kaimono  
shopping



# ショッピングセンター shoppingu sentā • shopping center

アトリウム  
atoriumu  
atrium

看板  
kaban  
sign

エレベーター  
erebētā  
elevator



3階  
sangai  
second floor

2階  
nikai  
first floor

エスカレーター  
esukarētā  
escalator

1階  
ikkai  
ground floor

客  
kyaku  
customer

## 関連用語 kanrenyōgo • vocabulary

子供用品売場  
kodomo yōhin uriba  
children's department

売場案内  
uriba annai  
store directory

試着室  
shichaku shitsu  
fitting rooms

これは、いくらですか。  
kore wa ikura desuka?  
How much is this?

鞆売場  
kaban uriba  
luggage department

店員  
ten'in  
sales clerk

ベビールーム  
bebī rūmu  
baby changing facilities

これを交換できますか。  
kore o kōkan dekimasuka?  
May I exchange this?

靴売場  
kutsu uriba  
shoe department

カスタマーサービス  
kasutamā sābisu  
customer services

お手洗い  
o-tearai  
restrooms



デパート depāto • department store



紳士服  
shinshi fuku  
men's wear



婦人服  
fujin fuku  
women's wear



ランジェリー  
ranjerī  
lingerie



香水売場  
kōsui uriba  
perfume



化粧品  
keshōhin  
beauty



寝具・タオル類  
shingu taoru rui  
bed and bath



家具  
kagu  
home furnishings



小間物  
komamono  
notions



台所用品  
daidokoro yōhin  
kitchenware



陶磁器  
tōjiki  
china



電気製品  
denki seihin  
electronics



照明器具  
shōmei kigu  
lighting



スポーツ用品  
supōtsu yōhin  
sporting goods



玩具  
omocha  
toys



文房具  
bumbōgu  
stationery



食品売場  
shokuhin uriba  
groceries

# スーパーマーケット sūpāmāketto • supermarket

通路  
tsūro  
aisle

棚  
tana  
shelf

ベルトコンベア  
beruto kombea  
conveyer belt

レジ係 特売品  
reji-gakari tokubaihin  
cashier specials



チェックアウト chekkuauto | checkout

客  
kyaku  
customer

レジ  
reji  
cash register

買い物袋  
kaimono-bukuro  
shopping bag



カート kato | cart

食料品  
shokuryōhin  
groceries

取っ手  
totte  
handle



籠 kago | basket



バーコード  
bākōdo  
bar code



バーコード読み取り装置 bākōdo yomitori sōchi | scanner





パン類  
pan rui  
bakery



乳製品  
nyūseihin  
dairy



シリアル食品  
shiriaru shokuhin  
breakfast cereals



缶詰  
kanzume  
canned food



菓子類  
kashi rui  
confectionery



野菜  
yasai  
vegetables



果物  
kudamono  
fruit



肉  
niku  
meat and poultry



魚  
sakana  
fish



デリカテッセン  
derikatessen  
deli



冷凍食品  
reitō shokuhin  
frozen food



インスタント食品  
insutanto shokuhin  
convenience food



飲物  
nomimono  
drinks



家庭用品  
katei yōhin  
household products



化粧品  
keshōhin  
toiletries



ベビー用品  
bebī yōhin  
baby products



電気製品  
denki seihin  
electrical goods



ペットフード  
petto fūdo  
pet food



雑誌 zasshi | magazines



# 薬局 yakkyoku • drugstore



アフターサンケア  
afutāsankea  
aftersun

サンスクリーン  
sansukurin  
sunscreen



日焼け止め  
hiyakedome  
sunblock



虫除け  
mushiyoke  
insect repellent



ウェットティッシュ  
wetto tisshu  
wet wipe



ティッシュ  
tissu  
tissue



生理用ナプキン  
seiri-yō napukin  
sanitary napkin



タンポン  
tampon  
tampon



パンティライナー  
panti rainā  
panty liner



カプセル  
kapuseru  
capsule



錠剤  
jōzai  
tablet

計量スプーン  
keiryō supūn  
measuring spoon



シロップ  
shiroppu  
syrup

用法  
yōhō  
instructions



吸入器  
kyūnyūki  
inhaler



クリーム  
kurīmu  
cream



軟膏  
nankō  
ointment



ジェル  
jeru  
gel



坐薬  
zayaku  
suppository



液体薬  
ekitai-gusuri  
drops

スポイト  
supoito  
dropper



注射器  
chūshaki  
syringe

注射針  
chūsha-bari  
needle



スプレー  
supurē  
spray



粉薬  
kona-gusuri  
powder

関連用語 kanrenyōgo • vocabulary

鉄分  
tetsubun  
iron

インスリン  
insurin  
insulin

使い捨て  
tsukaisute  
disposable

医薬品  
iyakuhin  
medicine

痛み止め  
itamidome  
analgesic

カルシウム  
karashiumu  
calcium

副作用  
fukusayō  
side-effects

水溶性  
suiyōsei  
soluble

下剤  
gezai  
laxative

鎮静剤  
chinsei-zai  
sedative

マグネシウム  
maguneshiumu  
magnesium

使用期限  
shiyō kigen  
expiration date

用量  
yōryō  
dosage

下痢  
geri  
diarrhea

睡眠薬  
suimin'yaku  
sleeping pill

マルチビタミン  
maruchi bitamin  
multivitamins

酔い止め  
yoidome  
travel sickness pills

投薬  
tōyaku  
medication

のど飴  
nodo ame  
sore throat lozenge

抗炎症剤  
kōenshō-zai  
antiinflammatory



# 花屋 hanaya • florist

花  
hana  
flowers

百合  
yuri  
lily

アカシア  
akashia  
acacia

カーネーション  
kâneshon  
carnation

植木  
ueki  
potted plant



グラジオラス  
gurajiorasu  
gladiolus

菖蒲  
ayame  
iris

ひな菊  
hinagiku  
daisy

菊  
kiku  
chrysanthemum

かすみ草  
kasumisō  
gypsophila



アラセイトウ  
araseitō  
stocks



ガーベラ  
gābera  
gerbera



群葉  
gun'yō  
foliage



薔薇  
bara  
roses



フリージア  
furijia  
freesia



アレンジメント arenjimento • arrangements

花瓶  
kabin  
vase



蘭  
ran  
orchid



牡丹  
botan  
peony

花束  
hanataba  
bunch

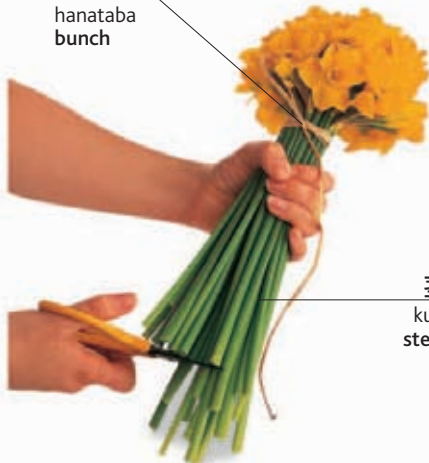

水仙  
suisen  
daffodil

茎  
kuki  
stem

蕾  
tsubomi  
bud



包装紙  
hōsō-shi  
wrapping

チューリップ chūrippu | tulip



リボン  
ribon  
ribbon

ブーケ  
būke  
bouquet



ドライフラワー  
dorai furawā  
dried flowers



ポプリ popuri | potpourri



花輪 hanawa | wreath



ガーランド  
gārando  
garland

メッセージを付けてください。  
messēji o tsukete kudasai?  
Can I attach a message?

何日ぐらい保ちますか。  
nannichi gurai tamochimasuka?  
How long will these last?

包んでください。  
tsutsunde kudasai?  
Can I have them wrapped?

香りがしますか。  
kaori ga shimasuka?  
Are they fragrant?

...に送っていただけますか。  
... ni okutte itadakemasuka?  
Can you send them to...?

...の花束をください。  
... no hanataba o kudasai?  
Can I have a bunch of... please?

# 新聞販売店 shimbun hambaiten • newsstand



煙草  
tabako  
cigarettes

煙草一箱  
tabako hitohako  
pack of cigarettes

マッチ  
matchi  
matches

宝くじ  
takarakuji  
lottery tickets

切手  
kitte  
stamps



絵葉書  
ehagaki  
postcard



漫画本  
manga-bon  
comic book



雑誌  
zasshi  
magazine



新聞  
shimbun  
newspaper

# 喫煙 kitsuen • smoking



刻み煙草  
kizami tabako  
tobacco



ライター  
raitā  
lighter

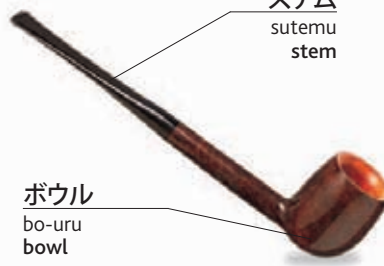

ボウル  
bo-uru  
bowl

パイプ  
paipu  
pipe

ステム  
sutemu  
stem



葉巻  
hamaki  
cigar



# 菓子屋 kashiya • confectioner

箱詰めチョコレート  
hako-zume chokorēto  
box of chocolates

チョコバー  
chokobā  
snack bar

ポテトチップス  
poteto chippusu  
chips



飴屋 ameya | sweet shop

## 関連用語 kanrenyōgo • vocabulary

ミルクチョコレート  
miruku chokorēto  
milk chocolate

キャラメル  
kyarameru  
caramel

スイートチョコレート  
suīto chokorēto  
dark chocolate

トラuffle  
toraffuru  
truffle

ホワイトチョコレート  
howaito chokorēto  
white chocolate

クッキー  
kukki  
cookie

ピクンミックス  
pikkunmikkusu  
pick-and-mix

飴  
ame  
hard candy

# 菓子 kashi • candy



チョコレート  
chokorēto  
chocolate



板チョコ  
itachoko  
chocolate bar



飴  
ame  
candies



棒付きキャンディー  
bō-tsuki kyandī  
lollipop



トフィー tofi | toffee



ヌガー  
nugā | nougat



マシュマロ  
mashumaro  
marshmallow



ハッカ飴  
hakka ame  
mint



ガム  
gamu  
chewing gum



ゼリービーンズ  
zerībinzu  
jellybean



フルーツガム  
furūtsu gamu  
gum drop



甘草飴  
kanzō ame  
licorice



## その他の店 sonota no mise • other stores



パン屋  
pan'ya  
bakery



ケーキ屋  
kēkiya  
pastry shop



肉屋  
nikuya  
butcher shop



魚屋  
sakanaya  
fish store



八百屋  
yaoya  
greengrocer



食料品店  
shokuryōhin-ten  
grocery store



靴屋  
kutsuya  
shoe store



金物屋  
kanamonoya  
hardware store



骨董屋  
kottōya  
antique shop



ギフトショップ  
gifuto shoppu  
gift shop



旅行代理店  
ryokō dairiten  
travel agency



宝石店  
hōseki-ten  
jewelry store



本屋  
hon'ya  
bookstore



レコード店  
rekōdo-ten  
record store



酒屋  
sakaya  
liquor store



ペットショップ  
petto shoppu  
pet store



家具屋  
kaguya  
furniture store



ブティック  
butikku  
boutique



仕立屋  
shitateya  
tailor



美容院  
biyōin  
salon

関連用語 kanrenyōgo • vocabulary

不動産屋  
fudōsan-ya  
real estate agency

カメラ屋  
kamera-ya  
camera store

園芸センター  
engei sentā  
garden center

健康食品店  
kenkō shokuhin-ten  
health food store

クリーニング屋  
kurīningu-ya  
dry cleaner's

画材屋  
gazai-ya  
art supply store

コインランドリー  
koin randorī  
laundromat

中古販売店  
chūko hambai-ten  
secondhand store



市場 ichiba | market







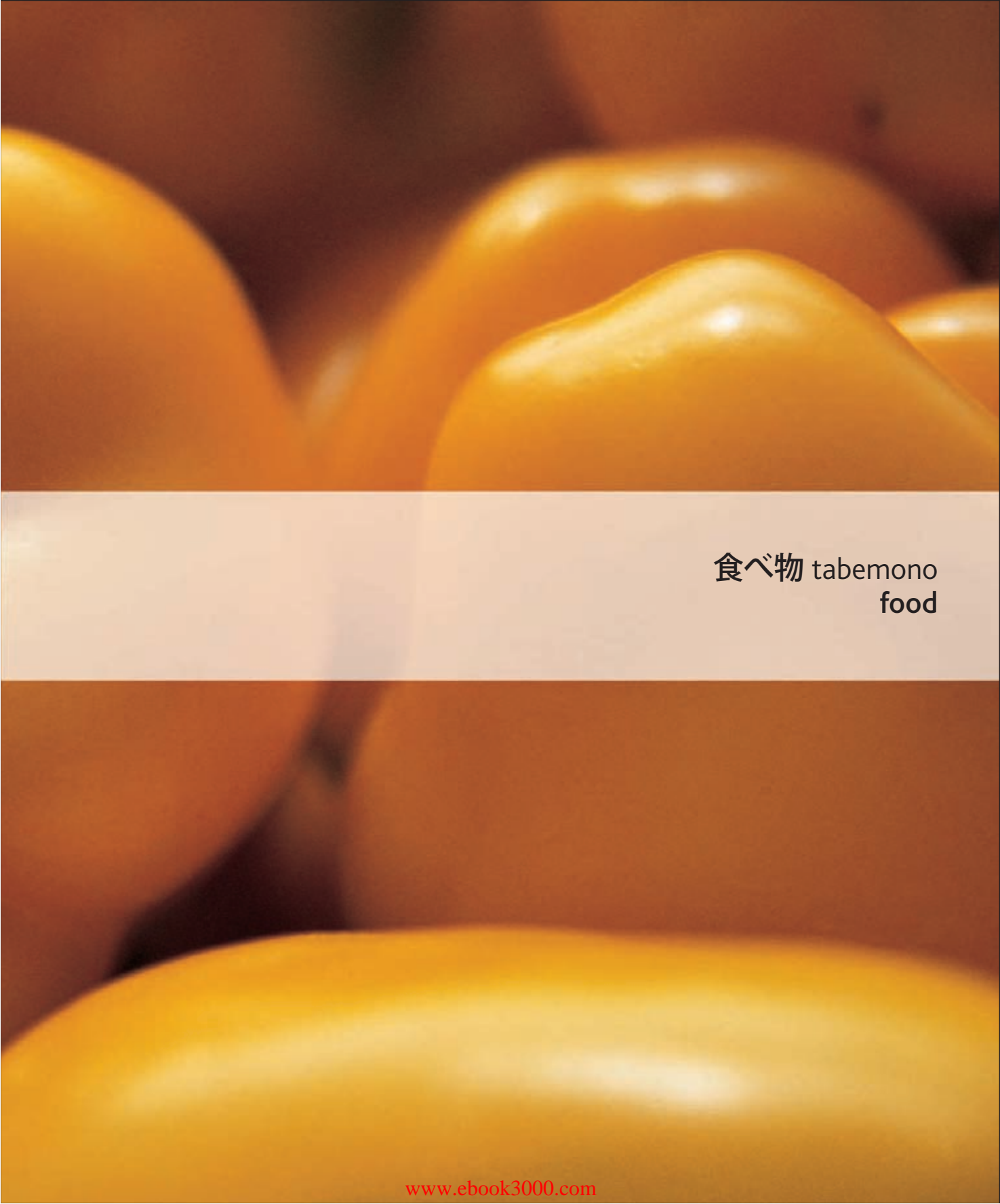

食べ物 tabemono  
food

# 肉 niku • meat



ラム肉  
ramu niku  
lamb

肉屋  
nikuya  
butcher

肉フック  
niku fukku  
meat hook

秤  
hakari  
scale

研ぎ棒  
togi-bō  
knife sharpener

ベーコン  
bēkon  
bacon

ソーセージ  
sōsēji  
sausages

レバー  
rebā  
liver

## 関連用語 kanrenyōgo • vocabulary

豚肉  
butaniku  
pork

鹿肉  
shika niku  
venison

内蔵  
naizō  
offal

放し飼いの  
hanashigai no  
free range

調理済み肉  
chōri-zumi niku  
cooked meat

牛肉  
gyūniku  
beef

ウサギ肉  
usagi niku  
rabbit

保存処理  
hozon shori  
cured

有機性  
yūki-sei  
organic

白身肉  
shiromi niku  
white meat

子牛肉  
ko-ushi niku  
veal

タン  
tan  
tongue

薫製  
kunsei  
smoked

低脂肪肉  
teishibō niku  
lean meat

赤身肉  
akami niku  
red meat

切り身 kirimi • cuts

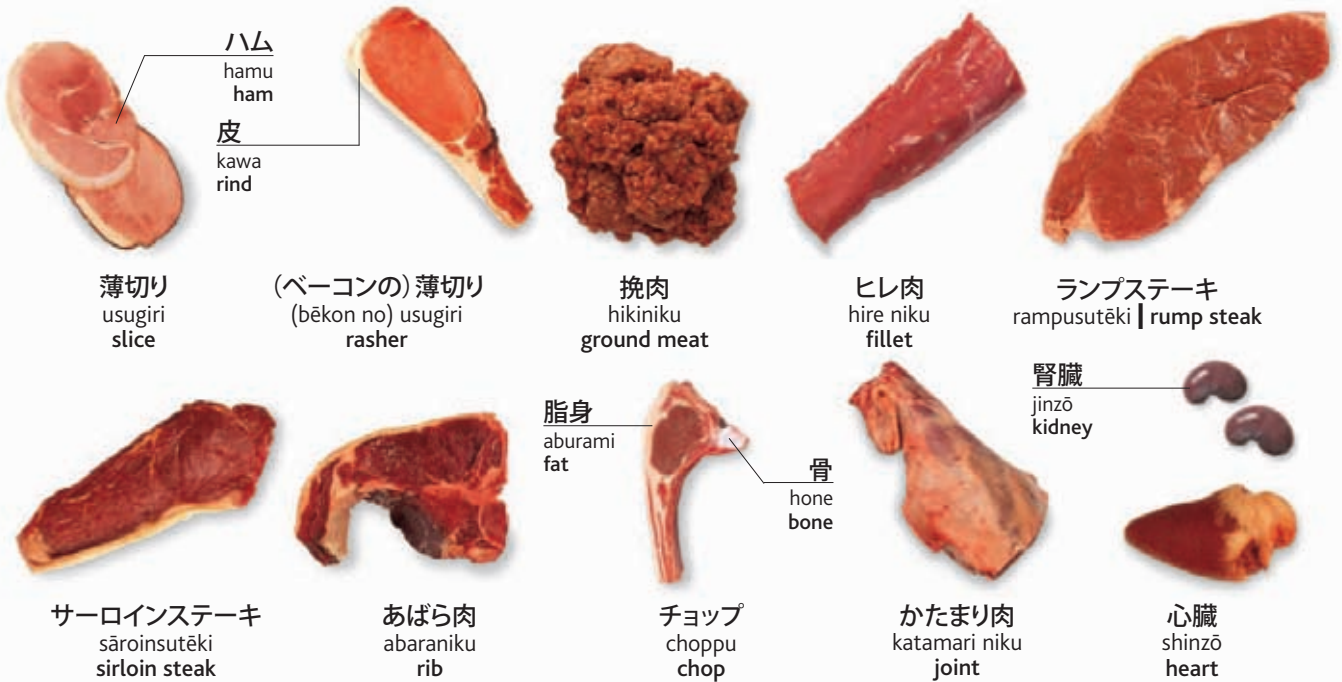

鳥肉 toriniku • poultry

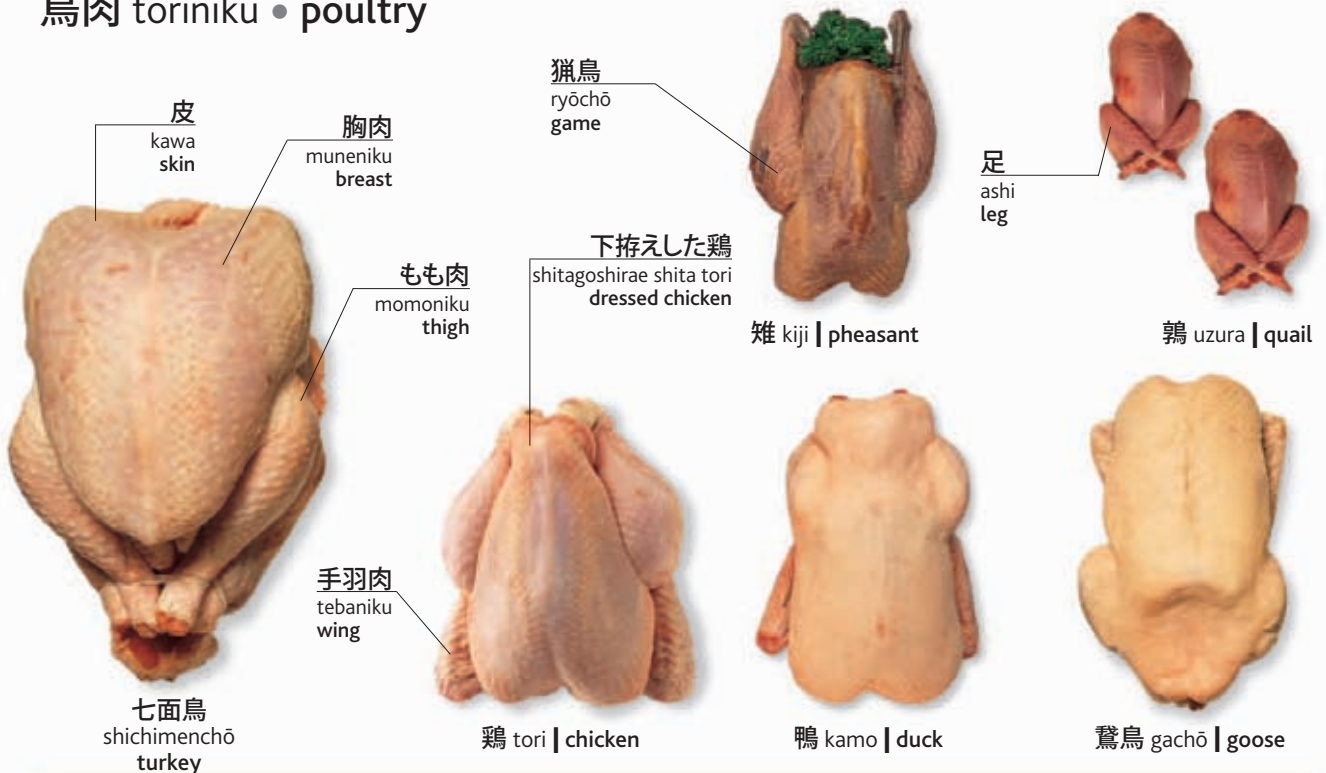



# 魚 sakana • fish

剥き海老  
mukiebi  
peeled shrimp

氷  
kōri  
ice

ヒメジ  
himeji  
red mullet

オヒョウの切り身  
ohyō no kirimi  
halibut fillets

虹鱒  
nijimasu  
rainbow trout

ガンギエイのヒレ  
gangiei no hire  
skate wings

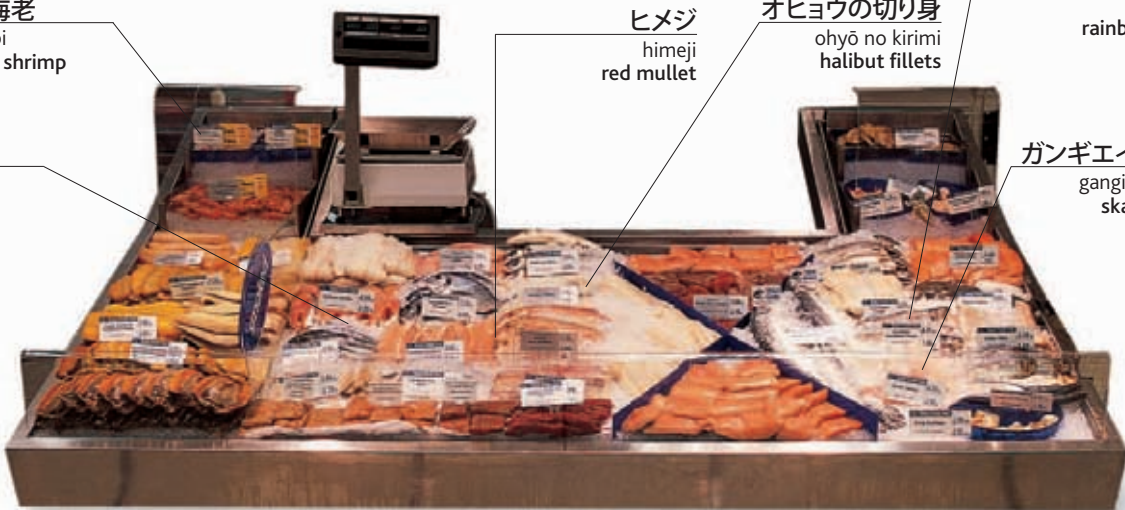

魚屋  
sakanaya  
fishmonger's



アンコウ  
ankō  
monkfish



鯖  
saba  
mackerel



鱒  
masu  
trout



メカジキ  
mekajiki  
swordfish



ドーバーカレイ  
dōbā karei  
Dover sole



レモンガレイ  
remon garei  
lemon sole



コダラ  
kodara  
haddock



鰯  
iwashi  
sardine



ガンギエイ  
gangiei  
skate



ホワイティング  
howaitingu  
whiting



スズキ  
suzuki  
sea bass



鮭 sake | salmon



鱈  
tara  
cod



鯛  
tai  
sea bream



鮪  
maguro  
tuna

海産物 kaisambutsu • seafood

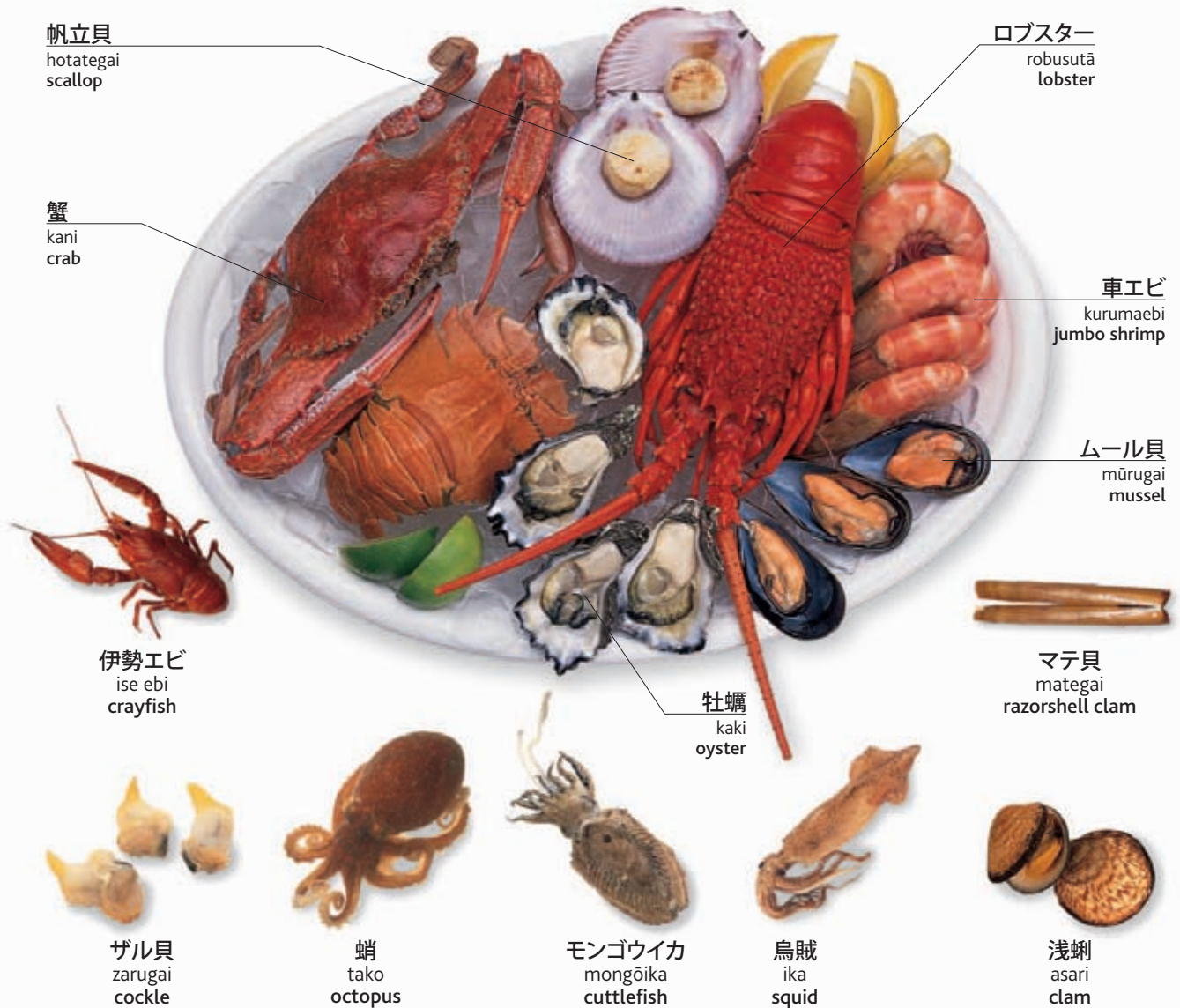

関連用語 kanrenyōgo • vocabulary

|                        |                                  |                                  |                                    |                              |                            |  |                   |                     |                      |                          |
|------------------------|----------------------------------|----------------------------------|------------------------------------|------------------------------|----------------------------|--|-------------------|---------------------|----------------------|--------------------------|
| 冷凍<br>reitō<br>frozen  | 塩ふり<br>shio-furi<br>salted       | 薫製<br>kunsei<br>smoked           | 鱗を取った<br>uroko o totta<br>descaled | 切り身<br>kirimī<br>fillet      | 厚切り<br>atsu-giri<br>loin   | 尾<br>o<br>tail   | 骨<br>hone<br>bone | 鱗<br>uroko<br>scale | 寿司<br>sushi<br>sushi | 刺身<br>sashimi<br>sashimi |
| 新鮮<br>shinsen<br>fresh | 腸を取った<br>wata o totta<br>cleaned | 皮を剥いた<br>kawa o muita<br>skinned | 骨を取った<br>hone o totta<br>boned     | おろした<br>oroshita<br>filleted | 筒切り<br>tsutsugiri<br>steak | 腸を取ってください。<br>wata o totte kudasai?<br>Will you clean it for me? |                   |                     |                      |                          |

# 野菜1 yasai • vegetables 1



空豆  
raimame  
fava bean



ライ豆  
sayamame  
runner beans

実  
mi  
seed



インゲン豆  
ingenmame  
green beans



エンドウ豆  
endōmame  
peas



トウモロコシ  
tōmorokoshi  
corn



もやし  
moyashi  
bean sprouts



筍  
takenoko  
bamboo

莢  
saya  
pod



オクラ  
okura  
okra



セロリ  
serori  
celery



チコリ  
chikori  
chicory



茴香  
uikyō  
fennel



パルメット椰子の芯  
parumetto yashi no shin  
palm hearts

## 関連用語 kanrenyōgo • vocabulary

白菜  
hakusai  
Chinese leaves

莖  
kuki  
stalk

種  
tane  
kernel

芯  
shin  
heart

有機野菜はありますか。  
yūki yasai wa arimasuka?  
Do you sell organic vegetables?

葉  
ha  
leaf

房  
fusa  
florete

先端  
sentan  
tip

有機(栽培)  
yūki (saibai)  
organic

これは地元産ですか。  
kore wa jimoto-san desuka?  
Are these grown locally?





ロケットサラダ  
rokettsarada  
arugula



クレソン  
kureson  
watercress



赤チコリ  
aka chikori  
radicchio



芽キャベツ  
mekyabetsu  
brussels sprouts



フダンソウ  
fudansō  
Swiss chard



ケール  
kēru  
kale



ギシギシ  
gishigishi  
sorrel



エンダイブ  
endaibu  
endive



タンポポ  
tampopo  
dandelion



ほうレン草  
hōrensō  
spinach



コールラビ  
kōrurabi  
kohlrabi



チンゲン菜  
chingensai  
bok choy



レタス  
retasu  
lettuce



ブロッコリ  
burokkori  
broccoli



キャベツ  
kyabetsu  
cabbage



新キャベツ  
shin kyabetsu  
spring greens

# 野菜2 yasai • vegetables 2



## 関連用語 kanrenyōgo • vocabulary

プチトマト  
puchi tomato  
cherry tomato

タロ芋  
taroimo  
taro root

冷凍  
reitō  
frozen

苦い  
nigai  
bitter

ジャガイモを1キロください。  
jagaimo o ichi kiro kudasai.  
One kilo of potatoes, please.

人参  
ninjin  
carrot

菱の実  
hishi no mi  
water chestnut

生  
nama  
raw

硬い  
katai  
firm

1キロいくらですか。  
ichi kiro ikura desuka?  
What's the price per kilo?

新ジャガ  
shinjaga  
new potato

椎茸  
shītake  
shitake  
mushrooms

辛い  
karai  
hot (spicy)

果肉  
kaniku  
flesh

あれは何と言いますか。  
are wa nan to īmasuka?  
What are those called?

セロリアック  
seroriakku  
celeriac

わさび  
wasabi  
Japanese  
horseradish

甘い  
amai  
sweet

根  
ne  
root



薩摩芋  
satsumaimo  
sweet potato



山芋  
yamaimo  
yam



ビートルート  
bītorūto  
beet



ルタバガ  
rutabaga  
rutabaga



菊芋  
kikuimo  
jerusalem artichoke



西洋ワサビ  
seiyouwasabi  
horseradish



パースニップ  
pāsunippu  
parsnip



生姜  
shōga  
ginger



茄子  
nasu  
eggplant



トマト  
tomato  
tomato



スプリングオニオン  
supringu onion  
green onion



ニラネギ  
niranegi  
leek



エシャロット  
esharotto  
shallot



大蒜  
ninniku  
garlic

丁字  
chōji  
clove



トリュフ  
toryufu  
truffle

マッシュルーム  
masshurūmu  
mushrooms



胡瓜  
kyūri  
cucumber



ズッキーニ  
zukkīni  
zucchini



バターナットスクワッシュ  
batānatto sukuwasshu  
butternut squash



ドングリカボチャ  
donguri kabocha  
acorn squash



南瓜  
kabocha  
pumpkin



# 果物1 kudamono • fruit 1

## 柑橘類 kankitsu rui • citrus fruit



オレンジ  
orenji  
orange



クレメンティン  
kurementin  
clementine



アグリフルーツ  
agurifurūtsu  
ugli fruit

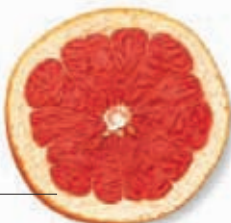

グレープフルーツ  
gurēpufurūtsu  
grapefruit

筋  
suji  
pith

房  
fusa  
segment



薩摩みかん  
satsuma mikan  
satsuma



タンジェリン  
tanjerin  
tangerine



ライム  
raimu  
lime

皮  
kawa  
zest



レモン  
remon  
lemon



金柑  
kinkan  
kumquat

## 石果 sekika • stone fruit



桃  
momo  
peach



ネクタリン  
nektarin  
nectarine



杏  
anzu  
apricot



プラム  
puramu  
plum



さくらんぼ  
sakurambo  
cherry

洋梨  
yōnashi  
pear

林檎  
ringo  
apple



果物籠 kudamono kago | basket of fruit

液果とメロン ekika to meron • berries and melons



苺  
ichigo  
strawberry



ラズベリー  
razuberī  
raspberry



メロン  
meron  
melon



葡萄  
budō  
grapes



ブラックベリー  
burakkuberī  
blackberry



レッドカラント  
reddokaranto  
redcurrant

皮  
kawa  
rind



ブラックカラント  
burakkukaranto  
blackcurrant

種  
tane  
seed



クランベリー  
kuranberī  
cranberry



ブルーベリー  
burūberī  
blueberry



ホワイトカラント  
howaitokaranto  
whitecurrant

果肉  
kaniku  
flesh



西瓜  
suika  
watermelon



ローガンベリー  
rōganberī  
loganberry



グーズベリー  
gūzuberī  
gooseberry

関連用語 kanrenyōgo • vocabulary

ダイオウ  
daiō  
rhubarb

酸っぱい  
suppai  
sour

パリッとした  
parittoshita  
crisp

果汁  
kajū  
juice

熟していますか。  
jukushite imasuka?  
Are they ripe?

繊維  
sen'i  
fiber

新鮮  
shinsen  
fresh

腐った  
kusatta  
rotten

芯  
shin  
core

試食できますか。  
shishoku dekimasuka?  
May I try one?

甘い  
amai  
sweet

みずみずしい  
mizumizushī  
juicy

(柔らかい) 果肉  
(yawarakai) kaniku  
pulp

種なし  
tanenashi  
seedless

何日ぐらい保ちますか。  
nannichi gurai tamochimasuka?  
How long will they keep?

# 果物2 kudamono 2 • fruit 2



マルメロ  
marumero  
quince



パッションフルーツ  
passhonfurūtsu  
passion fruit



バナナ  
banana  
banana



グアバ  
guaba  
guava



石榴  
zakuro  
pomegranate



柿  
kaki  
persimmon



フェイスジョア  
fejjoa  
fejjoa



ウチワサボテン  
uchiwasaboten  
prickly pear



スターフルーツ  
sutāfurūtsu  
starfruit



コダチトマト  
kodachitomato  
tamarillo



ナッツとドライフルーツ nattsu to doraifurūtsu • nuts and dried fruit



松の実  
matsu no mi  
pine nut



ピスタチオ  
pisutachio  
pistachio



カシューナッツ  
kashūnattsu  
cashew



ピーナッツ  
pīnattsu  
peanut



ヘーゼルナッツ  
hēzerunattsu  
hazelnut



ブラジルナッツ  
burajirunattsu  
brazil nut



ピーカンナッツ  
pīkannattsu  
pecan



アーモンド  
āmondo  
almond



胡桃  
kurumi  
walnut



栗  
kuri  
chestnut



マカデミアナッツ  
makademianattsu  
macadamia



無花果  
ichijiku  
fig



棗  
natsume  
date



李  
sumomo  
prune

殻  
kara  
shell



果肉  
kaniku  
flesh



サルタナレーズン  
sarutana rēzun  
seedless raisin



干し葡萄  
hoshibudō  
raisin



カラント  
karanto  
currant

ココナッツ  
kokonattsu  
coconut

関連用語 kanrenyōgo • vocabulary

青い  
aoi  
green

硬い  
katai  
hard

仁  
nin  
kernel

塩  
shio  
salted

煎った  
itta  
roasted

殻を剥いた  
kara o muita  
shelled

砂糖漬け果物  
satōzuke  
kudamono  
candied fruit

完熟  
kanjuku  
ripe

柔らかい  
yawarakai  
soft

乾燥  
kansō  
desiccated

生  
nama  
raw

季節もの  
kisetsu mono  
seasonal

丸ごと  
marugoto  
whole

熱帯果実  
nettai kajitsu  
tropical fruit

# 穀類と豆類 kokurui to mamerui • grains and legumes

## 穀類 kokurui • grains



小麦  
komugi  
wheat



からす麦  
karasumugi  
oats



大麦  
omugi  
barley



キビ  
kibi  
millet



トウモロコシ  
tomorokoshi  
corn

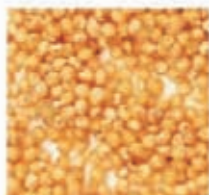

キノア  
kinoa  
quinoa

### 関連用語 kanrenyōgo • vocabulary

|                          |   |                                      |
|--------------------------|---|--------------------------------------|
| 種<br>tane<br>seed        | 香りのある<br>kaori no aru<br>fragranced       | スピードクック<br>supīdo kukku<br>easy cook |
| 殻<br>kara<br>husk        | シリアル食品<br>shiriaru shokuhin<br>cereal     | 長粒<br>chōryū<br>long-grain           |
| 穀粒<br>kokuryū<br>kernel  | 全粒<br>zenryū<br>whole-grain               | 短粒<br>tanryū<br>short-grain          |
| 乾燥<br>kansō<br>dry       | (水に) 漬ける<br>(mizu ni) tsukeru<br>soak (v) |                                      |
| 新しい<br>atarashī<br>fresh |   |                                      |

## 米 kome • rice



白米  
hakumai  
white rice



玄米  
genmai  
brown rice



野生米  
yasei mai  
wild rice



プディングライス  
pudinguraisu  
arborio rice

## 加工穀物 kakō kokumotsu • processed grains



クスクス  
kusukusu  
couscous



粗挽き麦  
arabiki mug  
cracked wheat



セモリナ  
semorina  
semolina



糠  
fusuma  
bran



豆類 mamerui • beans and peas



ライ豆  
raimame  
butter beans



いんげん豆  
ingenmame  
navy beans



金時豆  
kintoki mame  
red kidney beans



小豆  
azuki  
aduki beans



空豆  
soramame  
lima beans



大豆  
daizu  
soybeans



黒目豆  
kurome mame  
black-eyed beans



鶉豆  
uzura mame  
pinto beans



緑豆  
ryukutō  
mung beans



フラジョレ豆  
furajore mame  
flageolet beans



レンズ豆  
renzumame  
brown lentils



赤レンティル  
aka rentiru  
red lentils



グリーンピース  
gurin pīsu  
green peas



雛豆  
hiyoko mame  
chick peas



スプリットピー  
supuritto pī  
split peas

種 tane • seeds



南瓜の種  
kabocha no tane  
pumpkin seed



辛子の種  
karashi no tane  
mustard seed



キャラウェイシード  
kyarawei shīdo  
caraway



胡麻  
goma  
sesame seed



向日葵の種  
himawari no tane  
sunflower seed



# ハーブと香辛料 hābu to kōshinryō • herbs and spices

## 香辛料 kōshinryō • spices



バニラ banira | vanilla



ナツメグ  
natsumeggu  
nutmeg



メース  
mēsu  
mace



ウコン  
ukon  
turmeric



クミン  
kumin  
cumin



ブーケガルニ  
būkegaruni  
bouquet garni



オールスパイス  
ōrusupaisu  
allspice



胡椒の実  
koshō no mi  
peppercorn



フェヌグreek  
fenugurīku  
fenugreek



唐辛子  
tōgarashi  
chili pepper

丸ごと  
marugoto  
whole

つぶした  
tsubushita  
crushed



サフラン  
safuran  
saffron



カルダモン  
karudamon  
cardamom



カレー粉  
karēko  
curry powder



パウダー  
paudā  
ground

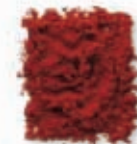

パプリカ  
papurika  
paprika

フレーク  
furēku  
flakes



大蒜  
ninniku  
garlic

ハーブ hābu • herbs

スティック  
sutikku  
sticks



シナモン  
shinamon  
cinnamon



レモングラス  
remongurasu  
lemongrass



クローブ  
kurōbu  
cloves



大茴香  
daiiikyō  
star anise



生姜  
shōga  
ginger

茴香の種  
uikyō no tane  
fennel seeds



茴香  
uikyō  
fennel



朝葱  
asatsuki  
chives



ハッカ  
hakka  
mint



タラゴン  
taragon  
tarragon



マジョラム  
majoramu  
marjoram



オレガノ  
oregano  
oregano



コリアンダー  
koriandā  
cilantro



ローリエ  
rōrie  
bay leaf



タイム  
taimu  
thyme



バジリコ  
bajiriko  
basil



ディル  
diru  
dill



パセリ  
paseri  
parsley



セージ  
sēji  
sage



ローズマリー  
rōzumarī  
rosemary



# 瓶詰め食品 binzume shokuhin • bottled foods



# 甘味スプレッド kanmi supureddo • sweet spreads





薬味とスプレッド yakumi to supureddo  
 ● condiments and spreads



マヨネーズ  
mayonēzu  
mayonnaise



チャツネ  
chatsune  
chutney

林檎酢  
ringo su  
cider vinegar



モルト酢  
moruto su  
malt vinegar



バルサミコ酢  
barusamiko su  
balsamic vinegar



ワイン酢  
wain su  
wine vinegar

酢  
su  
vinegar

瓶  
bin  
bottle



ケチャップ  
kechappu  
ketchup



ソース  
sōsu  
sauce



イングリッシュマスタード  
ingurisshu masutādo  
English mustard



ディジョンマスタード  
dijon masutādo  
French mustard



粒マスタード  
tsubu masutādo  
whole-grain mustard

密封瓶  
mippū bin  
sealed jar



ピーナッツバター  
pīnattsubatā  
peanut butter



チョコレートスプレッド  
chokorēto supureddo  
chocolate spread



瓶詰めフルーツ  
binzume furūtsu  
preserved fruit

関連用語 kanrenyōgo

● vocabulary

コーン油  
kōn yu  
corn oil

落花生油  
rakkasei yu  
peanut oil

サラダ油  
sarada yu  
vegetable oil

菜種油  
natane abura  
canola oil

コールドプレス油  
kōrudopuresu yu  
cold-pressed oil

醤油  
shōyu  
soy sauce

米酢  
komezu  
rice vinegar

# 乳製品 nyūseihin • dairy produce

## チーズ chīzu • cheese

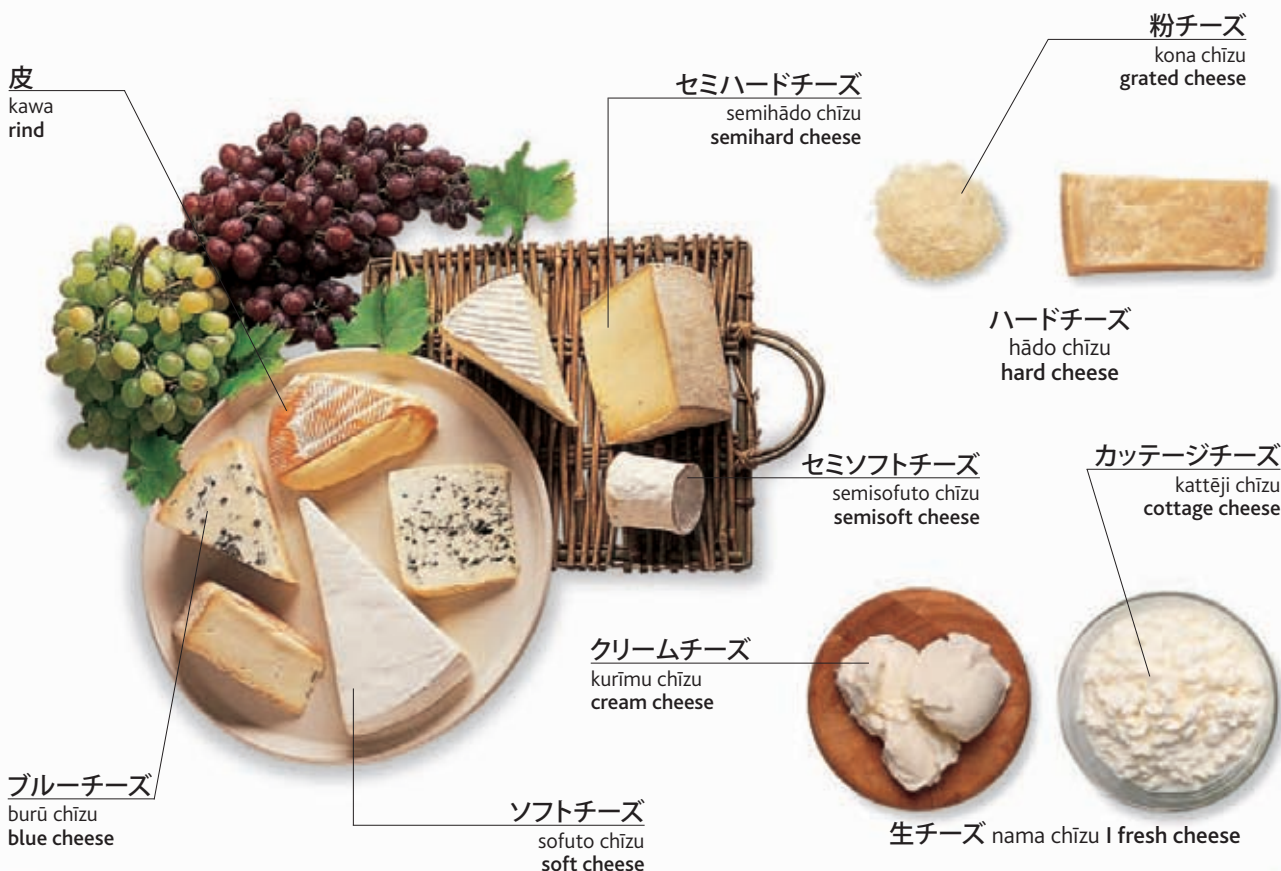

## ミルク miruku • milk





バター  
batā  
butter



マーガリン  
māgarin  
margarine



生クリーム  
nama kurīmu  
cream



シングルクリーム  
shinguru kurīmu  
light cream



ダブルクリーム  
daburu kurīmu  
double cream



ホイップクリーム  
hoippu kurīmu  
whipped cream



サワークリーム  
sawā kurīmu  
sour cream



ヨーグルト  
yōguruto  
yogurt



アイスクリーム  
aisukurīmu  
ice cream

## 卵 tamago • eggs

卵黄  
ran'ō  
yolk

卵白  
rampaku  
egg white

殻  
kara  
shell

エッグカップ  
eggu kappu  
egg cup

ゆで卵 yudetamago | boiled egg



鶏卵  
keiran  
hen's egg



家鴨の卵  
ahiru no tamago  
duck egg



鵞鳥の卵  
gachō no tamago  
goose egg



鶉卵  
uzura tamago  
quail egg

## 関連用語 kanrenyōgo • vocabulary

低温殺菌  
teionsakkin  
pasteurized

ミルクセーキ  
mirukuseki  
milkshake

塩入り  
shio-iri  
salted

羊乳  
yōnyū  
sheep's milk

乳糖  
nyūtō  
lactose

ホモジナイズ  
homojinaizu  
homogenized

低温殺菌していない  
teionsakkin shiteinai  
unpasteurized

フローズンヨーグルト  
furōzun yōguruto  
frozen yogurt

無塩  
muen  
unsalted

バターミルク  
batāmiruku  
buttermilk

無脂肪  
mu-shibō  
fat-free

粉乳  
funnyū  
powdered milk



# パンと小麦粉 pan to komugiko • breads and flours

スライス食パン  
suraisu shokupan  
sliced bread

ケシの実  
keshi no mi  
poppy seeds

ライ麦パン  
raimugi pan  
rye bread

バゲット  
bagetto  
baguette



パン屋 pan'ya | bakery

## パン作り pan-zukuri • making bread



白小麦粉  
shiro komugiko  
white flour



黒小麦粉  
kuro komugiko  
brown flour



全粒粉  
zenryū-fun  
whole-wheat flour



酵母  
kōbo  
yeast



篩にかける furui ni kakeru  
sift (v)



混ぜる mazeru | mix (v)

パン生地  
pan kiji  
dough



こねる koneru | knead (v)



焼く yaku | bake (v)



耳  
mimi  
crust

白パン  
shiro pan  
white bread



食パンの塊  
shokupan no  
katamari  
loaf

黒パン  
kuro pan  
brown bread



全粒パン  
zenryū pan  
whole-wheat bread

スライス  
suraisu  
slice



グラナリブレッド  
guranari bureddo  
multigrain bread



とうもろこしパン  
tōmorokoshi pan  
cornbread



ソーダパン  
sōda pan  
soda bread



サワードウブレッド  
sawādo-u bureddo  
sourdough bread



フラットブレッド  
furattobureddo  
flatbread



ベーグル  
bēguru  
bagel



バップ  
bappu | bun



ロールパン  
rōrupan | roll



フルーツパン  
furūtsu pan  
fruit bread



種入りパン  
tane-iri pan  
seeded bread



ナン  
nan  
naan bread



ピタパン  
pita pan  
pita bread



クリスプブレッド  
kurisupu bureddo  
crispbread

関連用語 kanrenyōgo • vocabulary

強力粉  
kyōrikiko  
bread flour

膨れる  
fukureru  
rise (v)

発酵させる  
hakkō saseru  
prove (v)

パン粉  
panko  
breadcrumbs

スライサー  
suraisā  
slicer

膨らし粉入り小麦粉  
fukurashiko-iri komugiko  
self-raising flour

薄力粉  
hakurikiko  
all-purpose flour

グレーズを塗る  
gurēzu o nuru  
glaze (v)

波形  
namigata  
flute

パン職人  
pan shokunin  
baker

# ケーキとデザート kēki to dezāto • cakes and desserts

エクレア  
ekurea  
éclair

クリーム  
kurīmu  
cream

具  
gu  
filling

シュー皮  
shū-gawa  
choux pastry

パイ生地  
pai kiji  
puff pastry

フィロペストリー  
firo pesutori  
phyllo pastry



フルーツケーキ  
furūtsu kēki  
fruit cake

フルーツタルト  
furūtsu taruto  
fruit tart

メランゲ  
merange  
meringue

チョコレートを被せた  
chokorēto o kabuseta  
chocolate-coated

マフィン  
mafin  
muffin

スポンジケーキ  
suponji kēki  
sponge cake



ケーキ kēki | cakes

## 関連用語 kanrenyōgo • vocabulary

カスタードクリーム  
kasutādo kurīmu  
crème pâtissière

丸い小型パン  
marui kogata pan  
bun

ペストリー  
pesutori  
pastry

ライスプディング  
raisu pudingu  
rice pudding

一切れください。  
hitokire kudasai?  
May I have a slice please?

チョコレートケーキ  
chokorēto kēki  
chocolate cake

カスタード  
kasutādo  
custard

一切れ  
hitokire  
slice

お祝い  
oiwai  
celebration



チョコレートチップス  
chokorêto chippusu  
chocolate chip



スポンジフィンガー  
suponji fingā  
lady finger



フロレンティン  
furorentin  
florentine

トライフル  
toraifuru  
trifle

ビスケット bisuketto | biscuits



ムース  
mūsu  
mousse



シャーベット  
shābetto  
sorbet



クリームパイ  
kurīmu pai  
cream pie



プリン  
purin  
crème caramel

## お祝い用ケーキ oiwai-yō kēki • celebration cakes

最上段  
saijōdan  
top tier

リボン  
ribon  
ribbon

下段  
gedan  
bottom tier

アイシング  
aishingu  
icing

マジパン  
majipan  
marzipan



ウェディングケーキ wedingu kēki  
wedding cake

飾り  
kazari  
decoration

誕生日ケーキの蝋燭  
tanjōbi kēki no rōsoku  
birthday candles

吹き消す  
fukikesu  
blow out (v)



誕生日ケーキ tanjōbi kēki | birthday cake

# デリカテッセン derikatessen • delicatessen



油  
abura  
oil

スパイスの利いたソーセージ  
supaisu no kita sōsēji  
spicy sausage

酢  
su  
vinegar

生肉  
namaniku  
uncooked meat

カウンター  
kauntā  
counter

サラミ  
sarami  
salami

ペパロニ  
peparoni  
pepperoni



フラン  
furan  
flan

パテ  
pate  
pâté



モツアレチーズ  
motsarera chīzu  
mozzarella



ブリーチーズ  
burī chīzu  
brie



山羊チーズ  
yagi chīzu  
goat cheese



チェダーチーズ  
chedā chīzu  
cheddar



パルメザンチーズ  
parumezan chīzu  
parmesan



カマンベールチーズ  
kamanbēru chīzu  
camembert

皮  
kawa  
rind



エダムチーズ  
edamu chīzu  
edam



マンチェゴチーズ  
manchego chīzu  
manchego

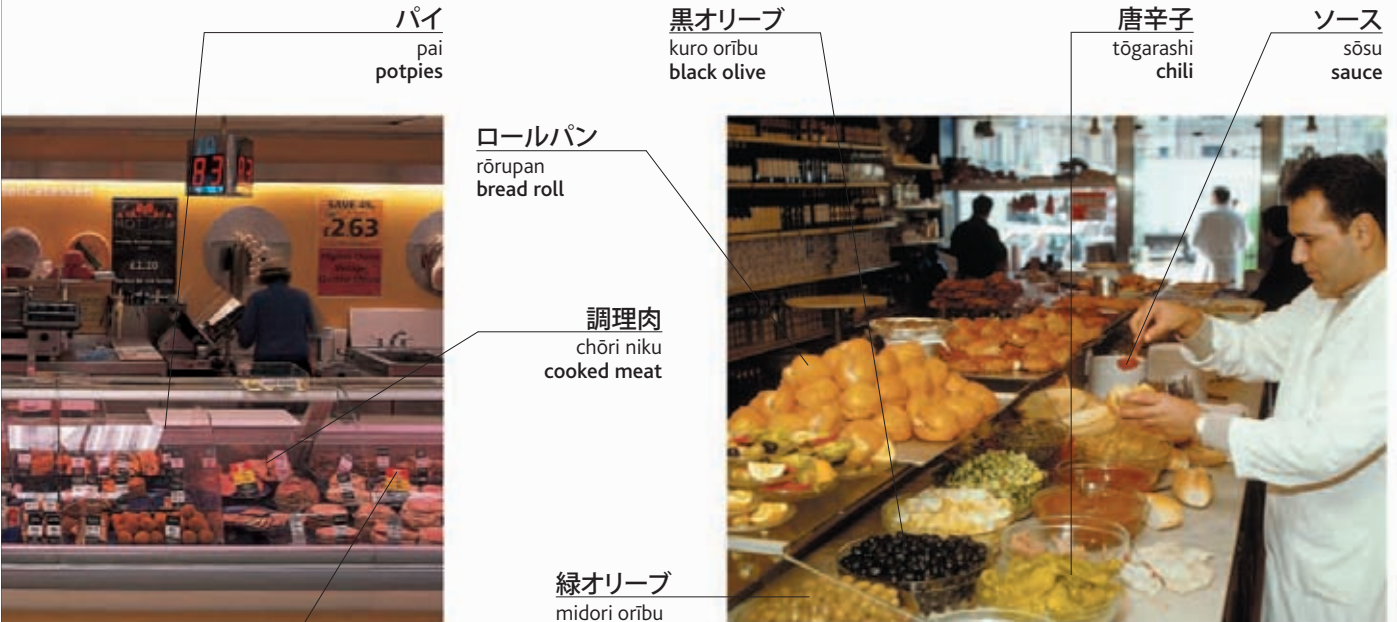

パイ  
pai  
potpies

黒オリーブ  
kuro oribu  
black olive

唐辛子  
tōgarashi  
chili

ソース  
sōsu  
sauce

ロールパン  
rōrupan  
bread roll

調理肉  
chōri niku  
cooked meat

緑オリーブ  
midori oribu  
green olive

ハム  
hamu  
ham

サンドイッチ売場 sandoitchi uriba | sandwich counter



魚の薫製  
sakana no kunsei  
smoked fish



ケーパー  
kēpā  
capers



プロシュット  
puroshutto  
prosciutto

チョリソ  
choriso  
chorizo



スタッフドオリーブ  
sutaffudo oribu  
stuffed olive

関連用語 kanrenyōgo • vocabulary

油漬け  
abura-zuke  
in oil

マリネ  
marine  
marinated

薫製  
kunsei  
smoked

塩水漬け  
shiomizu-zuke  
in brine

塩漬け  
shiozuke  
salted

保存処理  
hozon shori  
cured

番号札を取ってください。  
bangō fuda o totte kudasai.  
Take a number please.

それを試食できますか。  
sore o shishoku dekimasuka?  
May I try some of that please?

それを6切れください。  
sore o rokkire kudasai.  
Six slices of that, please



# 飲物 nomimono • drinks

## 水 mizu • water

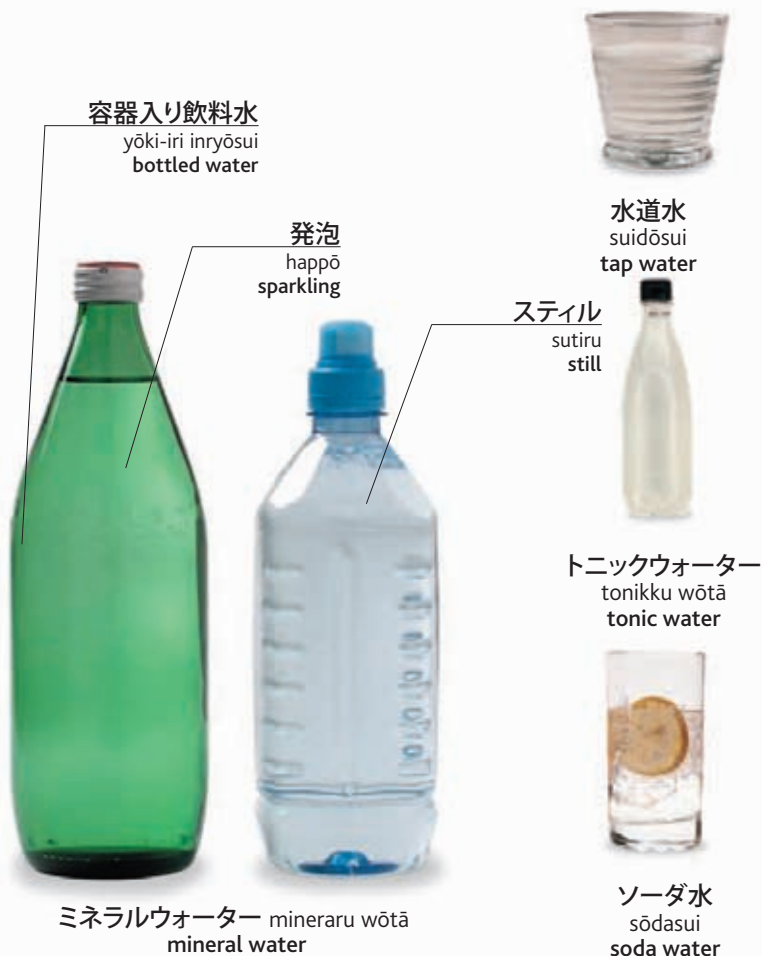

## 暖かい飲物 atataakai nomimono • hot drinks



## ソフトドリンク sofuto dorinku • soft drinks



アルコール飲料 arukōru inryō • alcoholic drinks



ジン  
jin | gin



ビール  
bīru  
beer

缶  
kan  
can



林檎酒  
ringoshu  
hard cider



ビター  
bitā  
bitter



黒ビール  
kurobīru  
stout



ウォッカ  
wokka | vodka



ウイスキー uisukī | whisky



ラム酒  
ramushu  
rum



ブランデー  
burandē  
brandy



ポートワイン  
pōtowain  
port



シェリー  
sherī  
sherry

辛口  
karakuchi  
dry



カンパリ  
kampari  
campari

ロゼ(ワイン)  
roze (wain)  
rosé (wine)

白(ワイン)  
shiro (wain)  
white (wine)

赤(ワイン)  
aka (wain)  
red (wine)



リキュール  
rikyūru  
liqueur



テキーラ  
tekīra  
tequila



シャンパン  
shampan  
champagne



ワイン wain | wine







外食 gaishoku  
eating out

# カフェ kafe • café



メニュー  
menyū  
menu

オーニング  
ōningu  
awning

路上カフェ rojō kafe | pavement café



パラソル  
parasoru  
umbrella

テラスカフェ  
terasu kafe  
terrace café

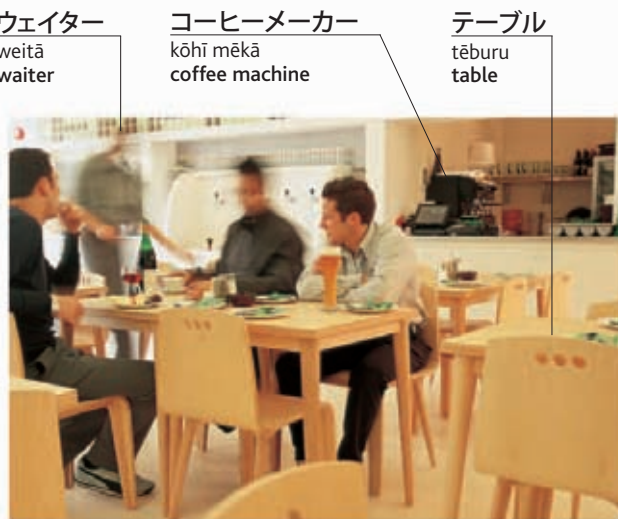

ウェイター  
weitā  
waiter

コーヒーマーカー  
kōhī mēkā  
coffee machine

テーブル  
tēburu  
table

スナックバー sunakku bā | snack bar

# コーヒー kōhī • coffee



ミルクコーヒー  
miruku kōhī  
white coffee

ブラックコーヒー  
burak kukōhī  
black coffee

ココアパウダー  
kokoa paudā  
cocoa powder

泡  
awa  
foam

フィルターコーヒー  
firutā kōhī  
filter coffee

エスプレッソ  
esupresso  
espresso

カプチーノ  
kapuchīno  
cappuccino

アイスコーヒー  
aisu kōhī  
iced coffee

## 紅茶 kōcha • tea

ハーブ茶  
hābu cha  
herbal tea



ミルクティー  
miruku tī  
tea with milk

紅茶  
kōcha  
black tea



カモミール茶  
kamomīru cha  
camomile tea



レモンティー  
remon tī  
tea with lemon



緑茶  
ryokucha  
green tea



ミントティー  
minto tī  
mint tea



アイスティー  
aisu tī  
iced tea

## ジュースとミルクセーキ jūsu to mirukusēki • juices and milkshakes



オレンジジュース  
orenji jūsu  
orange juice



林檎ジュース  
ringo jūsu  
apple juice



パイナップルジュース  
painappuru jūsu  
pineapple juice



トマトジュース  
tomato jūsu  
tomato juice

チョコレートミルクセーキ  
chokorēto mirukusēki  
chocolate milkshake

苺のミルクセーキ  
ichigo no mirukusēki  
strawberry milkshake

コーヒーミルクセーキ  
kōhī mirukusēki  
coffee milkshake



## 食べ物 tabemono • food

黒パン  
kuro pan  
brown bread

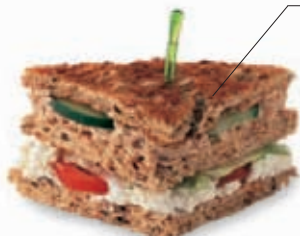

トーストサンド  
tōsuto-sando  
toasted sandwich



サラダ  
sarada  
salad

スクープ  
sukūpu  
scoop



アイスクリーム  
aisukurīmu  
ice cream



ペストリー  
pesutorī  
pastry



# バー bā • bar



グラス  
gurasu  
glasses

計量器  
keiryōki  
dispenser

レジ  
reji  
cash register

バーテン  
bāten  
bartender

タップ  
tappu  
beer tap

コーヒーマーカー  
kōhī mēkā  
coffee machine

アイスバケツ  
aisu baketsu  
ice bucket

バースツール  
bā sutsūru  
bar stool

灰皿  
haizara  
ashtray

コースター  
kōsutā  
coaster

カウンター  
kauntā  
bar counter

栓抜き  
sennuki  
bottle opener



レバー  
rebā  
lever

コルク栓抜き koruku sennuki | corkscrew

氷ばさみ  
kōri-basami  
tongs

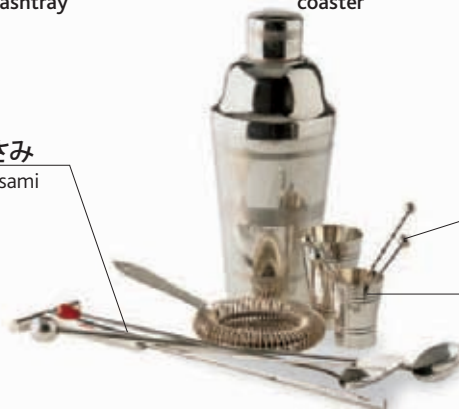

マドラー  
madorā  
stirrer

メジャーカップ  
mejā kappu  
measure

シェーカー shēkā  
cocktail shaker



ジントニック  
jintonikku  
gin and tonic

水差し  
mizusashi  
pitcher



スコッチの水割り  
sukotchi no mizuwari  
scotch and water



キューバリブレ  
kyūba ribure  
rum and coke

角氷  
kaku-gōri  
ice cube



スクリュードライバー  
sukuryū doraibā  
vodka and orange



マティーニ  
matīni  
martini



カクテル  
kakuteru  
cocktail



ワイン  
wain  
wine



ビール bīru | beer



ワンショット  
wanshotto  
a shot

シングル  
shinguru  
single



分量  
bunryō  
measure

ダブル  
daburu  
double



氷無し  
kōri nashi  
without ice

氷とレモン  
kōri to remon  
ice and lemon



氷入り  
kōri-iri  
with ice

## おつまみ o-tsumami • bar snacks



ポテトチップス poteto chippusu  
potato chips

アーモンド  
āmondo  
almonds



ナッツ nattsu | nuts

ピーナッツ  
pīnattsu  
peanuts



オリーブ oribu | olives

# レストラン resutoran • restaurant

**禁煙席**

kin'en seki  
nonsmoking  
section

**ナプキン**

napukin  
napkin

**コミシェフ**

komi shefu  
commis chef



キッチン kitchin | kitchen

**テーブルセッティング**

tēburu settingu  
table setting

**シェフ**

shefu  
chef



ウェイター weitā | waiter

**グラス**

gurasu  
glass

**トレイ**

torei  
tray

## 関連用語 kanrenyōgo • vocabulary

**ワインリスト**  
wain risuto  
wine list

**デザートワゴン**  
dezāto wagon  
dessert cart

**領収書**  
ryōshūsho  
receipt

**サービス料抜き**  
sābisu-ryō nuki  
service not included

**喫煙席**  
kitsuen seki  
smoking section

**胡椒**  
koshō  
pepper

**酒**  
sake  
rice wine

**値段**  
nedan  
price

**チップ**  
chippu  
tip

**ビュッフェ**  
byuffe  
buffet

**客**  
kyaku  
customer

**座卓**  
zatakō  
(low Japanese) table

**アラカルト**  
arakaruto  
à la carte

**会計**  
kaikei  
check

**サービス料込み**  
sābisu-ryō komi  
service included

**お薦め料理**  
o-susume ryōri  
specials

**塩**  
shio  
salt

**座布団**  
zabutōn  
(Japanese) cushion





メニュー  
menyū  
menu



お子様メニュー  
okosama menyū  
child's meal



注文する chūmon suru | order (v)



支払う shiharau | pay (v)

## コース料理 kōsu ryōri • courses



食前酒  
shokuzenshu  
aperitif



前菜  
zensai  
appetizer



スープ  
sūpu  
soup



主菜  
shusai  
main course



サイドオーダー  
saido ōdā  
side order

フォーク  
fōku  
fork



デザート dezāto  
dessert

コーヒースプーン  
kōhī supūn  
coffee spoon



コーヒー kōhī | coffee

2人分の席をお願いします。  
futari-bun no seki o onegaishimasu.  
A table for two please.

メニュー/ワインリストを見せてください。  
menyū/wainrisuto o misete kudasai?  
May I see the menu/winelist please?

セットメニューはありますか。  
setto menyū wa arimasuka?  
Is there a fixed price menu?

ベジタリアン料理はありますか。  
bejitarian ryōri wa arimasuka?  
Do you have any vegetarian dishes?

会計/領収書をお願いします。  
o-kaikai/ryōshūsho o onegaishimasu?  
Could I have the check/a receipt please?

会計は別々にお願いします。  
kaikai wa betsubetsu ni onegaishimasu?  
Can we pay separately?

お手洗いはどこですか。  
o-tearai wa doko desuka?  
Where are the restrooms, please?

# ファーストフード fāsuto fūdo • fast food

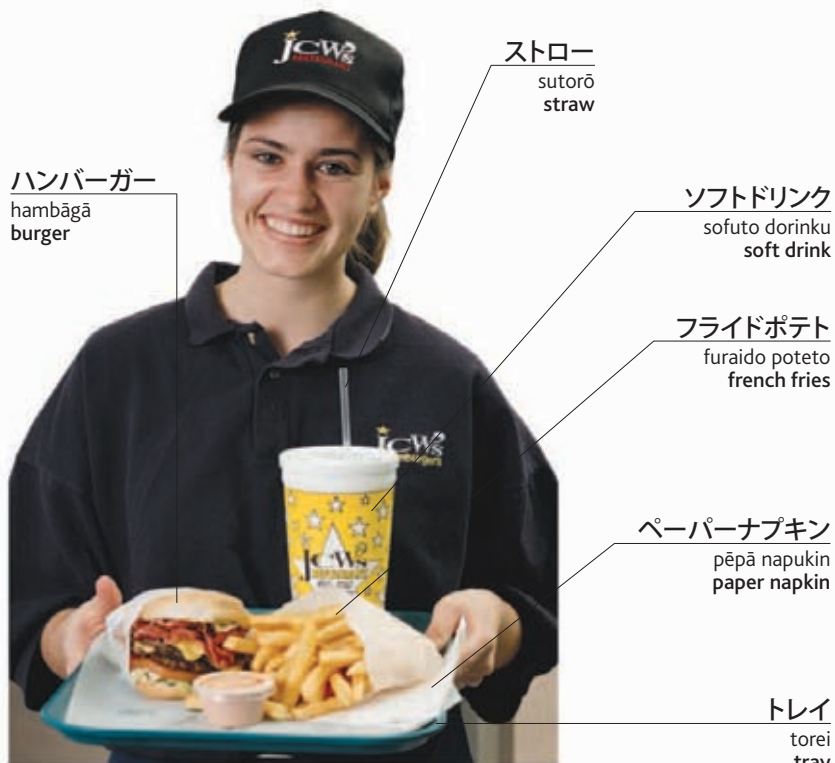

ハンバーガー  
hambāgā  
burger

ストロー  
sutorō  
straw

ソフトドリンク  
sofuto dorinku  
soft drink

フライドポテト  
furaido poteto  
french fries

ペーパーナプキン  
pēpā napukin  
paper napkin

トレイ  
torei  
tray

バーガーミール bāgā mīru | burger meal

ピザ  
piza  
pizza

価格表  
kakaku hyō  
price list

缶飲料  
kan inryō  
canned drink



宅配 takuhai | home delivery



露店 roten | street stand

## 関連用語 kanrenyōgo • vocabulary

ピザ屋  
piza-ya  
pizza parlor

ハンバーガー屋  
hambāgā-ya  
burger bar

メニュー  
menyū  
menu

店内飲食  
tennai inshoku  
eat-in

持ち帰り  
mochikaeri  
takeout

温め直す  
atatamaaosu  
reheat (v)

ケチャップ  
ketchappu  
ketchup

おにぎり  
onigiri  
rice ball

弁当  
bentō  
lunch box

それを持ち帰りにしてください。  
sore o mochikaeri ni shite kudasai?  
Can I have that to go, please?

出前はできますか。  
demaie wa dekimasuka?  
Do you deliver?



ハンバーガー  
hambāgā  
hamburger



チキンバーガー  
chikin bāgā  
chicken burger

バンズ  
banzu  
bun



ベジバーガー  
beji bāgā  
veggie burger

マスタード  
masutādo  
mustard

ソーセージ  
sōseji  
sausage



ホットドッグ hotto doggu  
hot dog



サンドイッチ  
sandoitchi  
sandwich



クラブサンド  
kurabu-sando  
club sandwich



オープンサンド  
ōpun-sando  
open-face sandwich

具  
gu  
filling



ラップサンド  
rappu-sando  
wrap



ケバブ  
kebabu  
kebab

ソース  
sōsu  
sauce



チキンナゲット  
chikin nagetto  
chicken nuggets

塩味  
shioaji  
savory



クレープ kurēpu | crêpes



甘い  
amai  
sweet

トッピング  
toppingu  
topping



フィッシュ&チップス  
fisshu ando chippusu  
fish and chips



スペアリブ  
supea ribu  
ribs



フライドチキン  
furaido chikin  
fried chicken



ピザ  
pizza  
pizza



# 朝食 chōshoku • breakfast

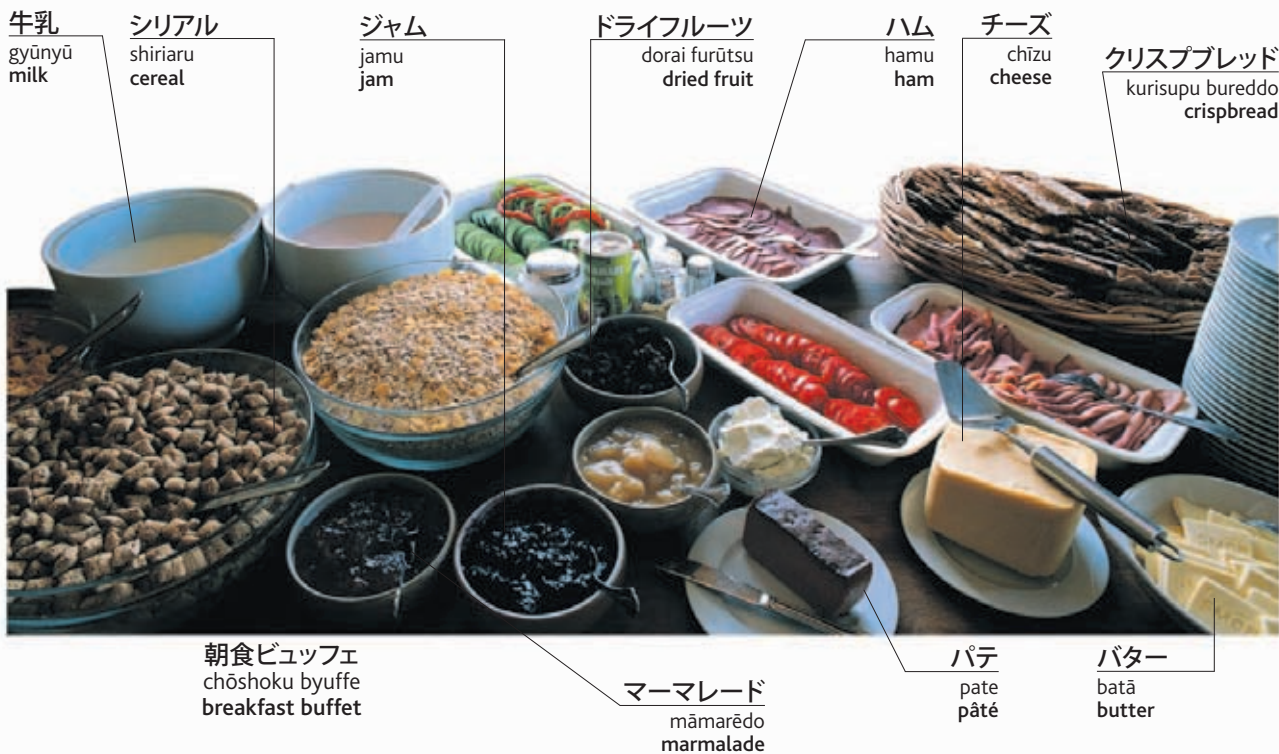

朝食のテーブル chōshoku no tēburu | breakfast table

飲物 nomimono | drinks



ブリオッシュ  
buriioshu  
brioche



パン  
pan  
bread

トースト  
tōsuto  
toast

目玉焼き  
medamayaki  
fried egg

トマト  
tomato  
tomato

ブラックプディング  
burakku pudingu  
black pudding

ソーセージ  
sōsēji  
sausage

ベーコン  
bēkon  
bacon

イングリッシュ・ブレイクファースト  
ingurissu burekkufāsuto  
English breakfast



薫製ニシン  
kunsei nishin  
kippers



フレンチトースト  
furenchi tōsuto  
french toast

黄身  
kimi  
yolk



ゆで卵  
yudetamago  
boiled egg



スクランブルエッグ  
sukuramburu eggu  
scrambled eggs

クリーム  
kurīmu  
cream



パンケーキ  
pankēki  
pancakes



ワッフル  
waffuru  
waffles

フルーツヨーグルト  
furūtsu yōguruto  
fruit yogurt



ポリッジ  
porijji  
oatmeal



フルーツサラダ  
furūtsu sarada  
fruit salad



# 食事 shokuji • dinner



スープ sūpu | soup



コンソメ konsome | broth



シチュー shichū | stew



カレー karē | curry



ロースト rōsuto | roast



ミートパイ mītopai | potpie



スフレ sufure | soufflé



ケbabu kebabu | kebab



ミートボール mīto bōru  
meatballs



オムレツ omuretsu  
omelet



焼きそば yaki shoba  
fried noodles

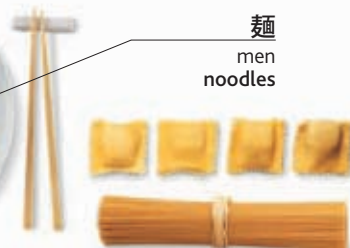

麵  
men  
noodles

パスタ pasuta  
pasta



ご飯 gohan | rice



ミックスサラダ mikkusu sarada  
tossed salad



グリーンサラダ gurīn sarada  
green salad



サラダドレッシング sarada  
doresshingu | dressing



調理方法 chōri hōhō • techniques



詰め物 tsumemono  
stuffed



煮込んだ nikonda | in sauce



(グリルで) 焼いた  
(guriru de) yaita | grilled



マリネ marine | marinated



(沸騰前の温度で) 茹でた (futto  
mae no ondo de) yudeta | poached



つぶした tsubushita  
mashed



(オーブンで) 焼いた  
(ōbun de) yaita | baked



(フライパンで) 焼いた  
(furaipan de) yaita | pan-fried



炒めた itameta | fried



ピクルス pikurusu | pickled



薫製 kunsei | smoked



揚げた ageta | deep-fried



シロップ漬け shiropu-zuke  
in syrup



ドレッシングをかけた  
doresshingu o kaketa | dressed



蒸した mushita | steamed



保存処理した  
hozon shori shita | cured









学習 *gakushū*  
study



# 学校 gakkō • school

先生  
sensei  
teacher

黒板  
kokuban  
blackboard



教室 kyōshitsu | classroom



男子生徒 danshi seito  
schoolboy

生徒  
seito  
pupil

学校の制服  
gakkō no seifuku  
school uniform

机  
tsukue  
desk

通学鞆  
tsūgaku kaban  
school bag

チョーク  
chōku  
chalk



女子生徒  
joshi seito  
schoolgirl

## 関連用語 kanrenyōgo • vocabulary

歴史  
rekishi  
history

科学  
kagaku  
science

物理  
butsuri  
physics

外国語  
gaikokugo  
languages

美術  
bijutsu  
art

化学  
kagaku  
chemistry

文学  
bungaku  
literature

音楽  
ongaku  
music

生物  
seibutsu  
biology

地理  
chiri  
geography

数学  
sūgaku  
math

体育  
tai'iku  
physical  
education

## 学業 gakugyō • activities



読む yomu | read (v)



書く kaku | write (v)



綴る tsuzuru | spell (v)



描く egaku | draw (v)



質問する shitsumon suru  
question (v)



答える kotaeru | answer (v)



話し合う hanashiau | discuss (v)



学ぶ manabu | learn (v)

関連用語 kanrenyōgo • vocabulary

校長先生  
kōchō sensei  
principal

答え  
kotae  
answer

成績  
seiseki  
grade

授業  
jugyō  
lesson

宿題  
shukudai  
homework

学年  
gakunen  
year

質問  
shitsumon  
question

試験  
shiken  
test

辞書  
jisho  
dictionary

ノートを取る  
nōto o toru  
take notes (v)

作文  
sakubun  
essay

百科事典  
hyakkajiten  
encyclopedia

# 数学 sūgaku • math

## 平面図形 heimenzukei • shapes

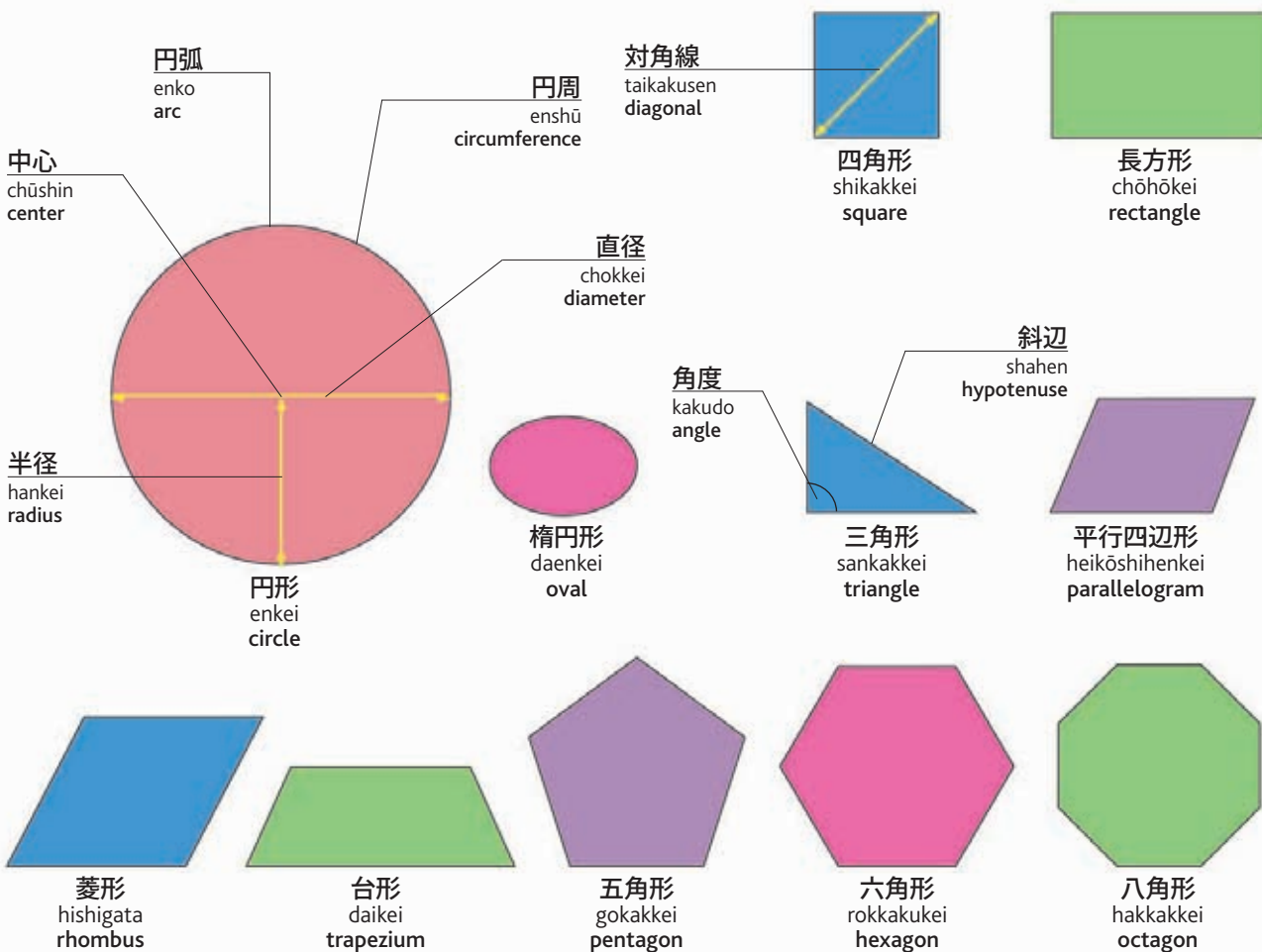

## 立体図形 rittaizukei • solids

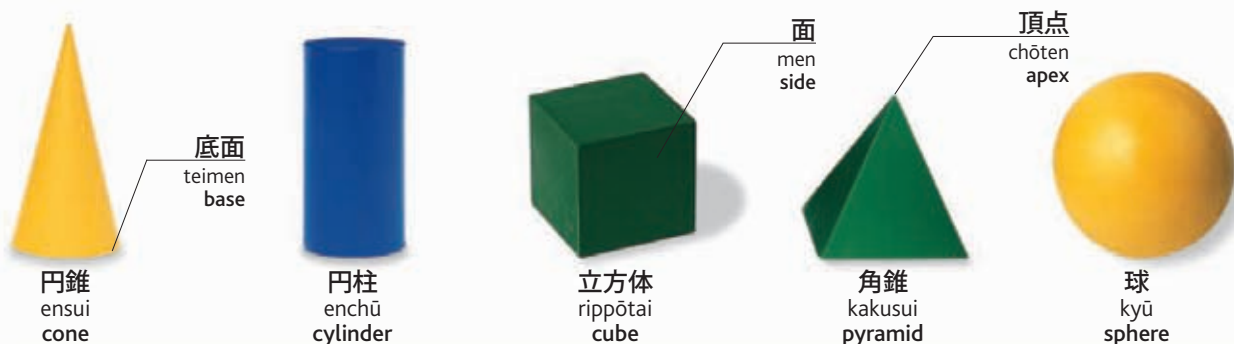



線 sen • lines



測定 sokutei • measurements

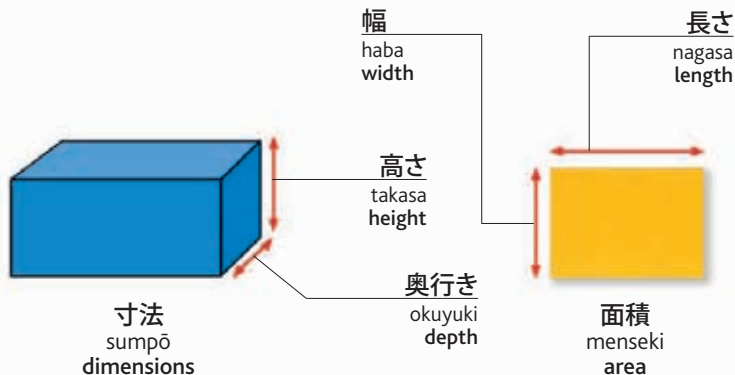
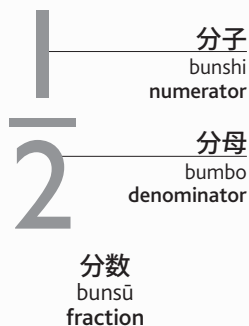

数学用品 sūgaku yōhin • equipment



関連用語 kanrenyōgo • vocabulary

幾何学  
kikagaku  
geometry

プラス  
purasu  
plus

掛ける  
kakeru  
times

イコール  
ikōru  
equals

足す  
tasu  
add (v)

掛ける  
kakeru  
multiply (v)

数式  
sūshiki  
equation

算数  
sansū  
arithmetic

マイナス  
mainasu  
minus

割る  
waru  
divided by

数える  
kazoeru  
count (v)

引く  
hiku  
subtract (v)

割る  
waru  
divide (v)

百分率  
hyakubunritsu  
percentage

# 科学 kagaku • science



実験室  
jikken shitsu  
laboratory

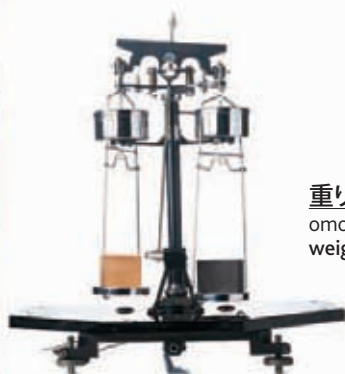

天秤  
tembin  
scale

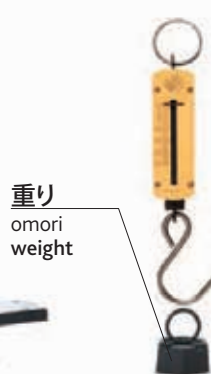

重り  
omori  
weight

バネ秤  
banebakari  
spring balance

坩堝  
rutsubo  
crucible



ブンゼンバーナー  
bunzen bānā  
bunsen burner

三脚  
sankyaku  
tripod



ガラス瓶  
garasu bin  
glass bottle

漏斗  
rōto  
funnel

フラスコ  
furasuko  
flask



スタンド  
sutando  
clamp stand

クランプ  
kurampu  
clamp

ストッパー  
sutoppā  
stopper

実験 jikken | experiment

試験管  
shikenkan  
test tube



試験管立て  
shikenkan-tate  
rack



タイマー  
taimā  
timer



シャーレー  
shārē  
petri dish



温度計  
ondokei  
thermometer

注射器  
chūshaki  
syringe

ピンセット  
pinsetto  
tweezers

メス  
mesu  
scalpel



スポイト supoito | dropper



鉗子 kanshi | forceps



トング tongu | tongs



へら hera | spatula

乳棒  
nyūbō  
pestle



乳鉢  
nyūbachi  
mortar



濾紙  
roshi  
filter paper



安全ゴーグル  
anzen gōguru  
safety goggles

接眼レンズ  
setsugan renzu  
eyepiece

焦点調節ノブ  
shōten chōsetsu nobu  
focusing knob



対物レンズ  
taibutsu renzu  
objective lens

試料台  
shiryō dai  
stage

スライド  
suraido  
slide

反射鏡  
hanshakyō  
mirror

顕微鏡 kembikyō | microscope



ガラス棒  
garasubō  
glass stirring rod



ビーカー  
bikā  
beaker

ピペット  
pipetto  
pipette



磁石  
jishaku  
magnet



鱷口クリップ  
waniguchi kurippu  
crocodile clip

負極  
fukyoku  
negative electrode



正極  
seikyoku  
positive electrode

電池 denchi | battery



# 大学 daigaku • college

スポーツフィールド

supōtsu firudo  
playing field

入学事務局

nyūgaku  
jimukyoku  
admissions

学生食堂

gakusei shokudō  
refectory

医療センター

iryō sentā  
health center



学生寮

gakusei ryō  
residence hall

図書目録

toshō mōkuroku  
card catalog

キャンパス kyampusu | campus

司書

shisho  
librarian



貸出カウンター

kashidashi kauntā  
circulation desk

書架

shoka  
bookshelf

定期刊行物

teiki kankōbutsu  
periodical

雑誌

zasshi  
journal



図書館 toshokan | library

## 関連用語 kanrenyōgo • vocabulary

図書カード

toshō kādo  
library card

問い合わせ

toiawase  
help desk

借出し

karidashi  
loan

閲覧室

etsuran shitsu  
reading room

借りる

kariru  
borrow (v)

本

hon  
book

読書リスト

dokusho risuto  
reading list

予約する

yoyaku suru  
reserve (v)

題名

daimēi  
title

返却日

henkyaku-bi  
return date

延長する

enchō suru  
renew (v)

通路

tsūro  
aisle

大学生  
daigakusei  
undergraduate

講師  
kōshi  
lecturer



講堂 kōdō | lecture hall

卒業生  
sotsugyōsei  
graduate

ローブ  
rōbu  
robe



卒業式 sotsugyō-shiki | graduation ceremony

## 専門学校 senmongakkō • schools



モデル  
moderu  
model

美術大学 bijutsu daigaku  
art college



音楽学校 ongaku gakkō  
music school



舞踊学院 buyō gakuin  
dance academy

## 関連用語 kanrenyōgo • vocabulary

奨学金  
shōgakuin  
scholarship

研究  
kenkyū  
research

学位論文  
gakui-rombun  
dissertation

医学  
igaku  
medicine

哲学  
tetsugaku  
philosophy

卒業証書  
sotsugyō-shōsho  
diploma

修士号  
shūshi gō  
master's

学部  
gakubu  
department

動物学  
dōbutsugaku  
zoology

文学  
bungaku  
literature

学位  
gakui  
degree

博士号  
hakase gō  
doctorate

法学  
hōgaku  
law

物理学  
butsurigaku  
physics

美術史  
bijutsushi  
art history

大学院  
daigakuin  
postgraduate

卒業論文  
sotsugyō-rombun  
thesis

工学  
kōgaku  
engineering

政治学  
seijigaku  
politics

経済学  
keizaigaku  
economics



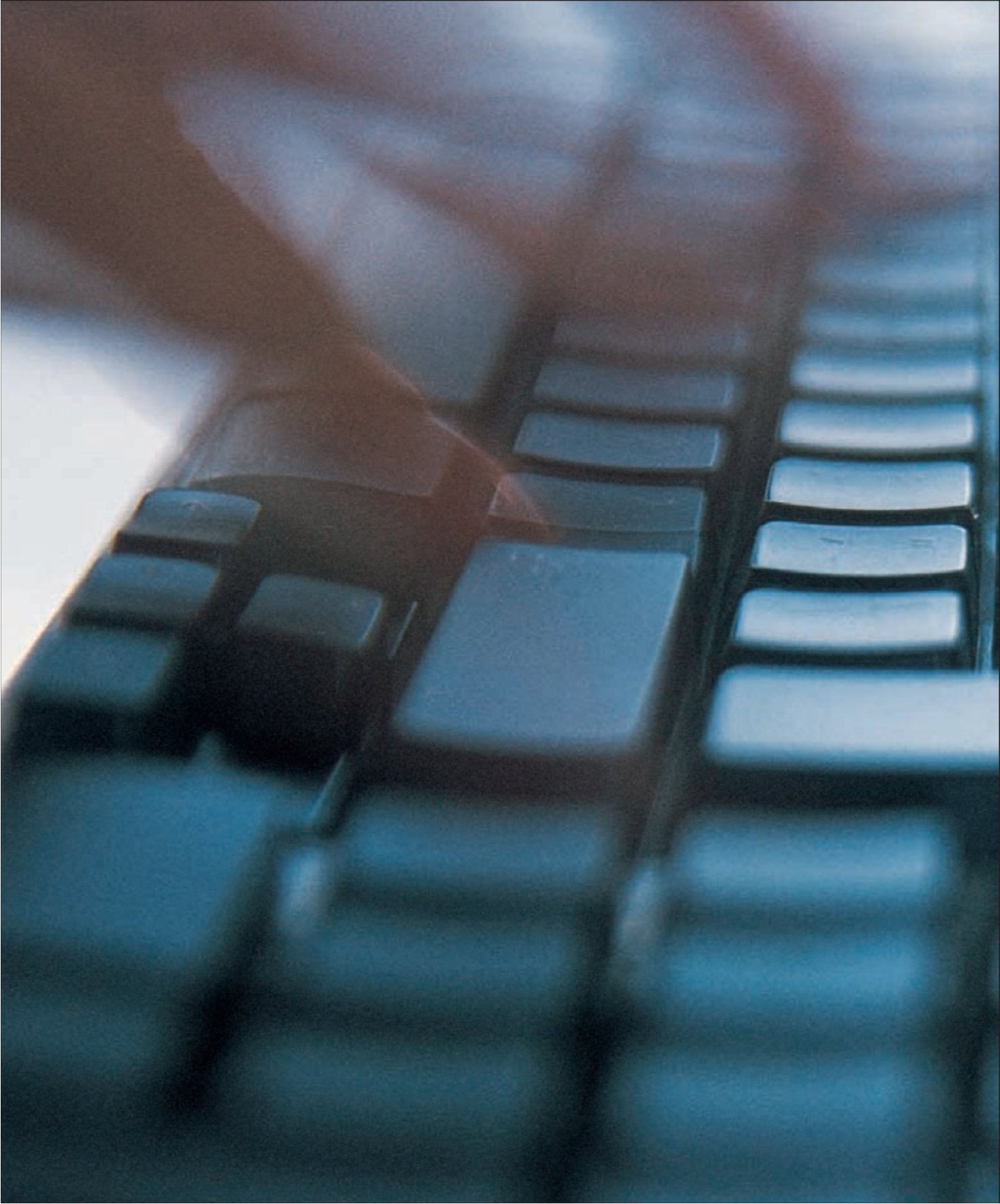



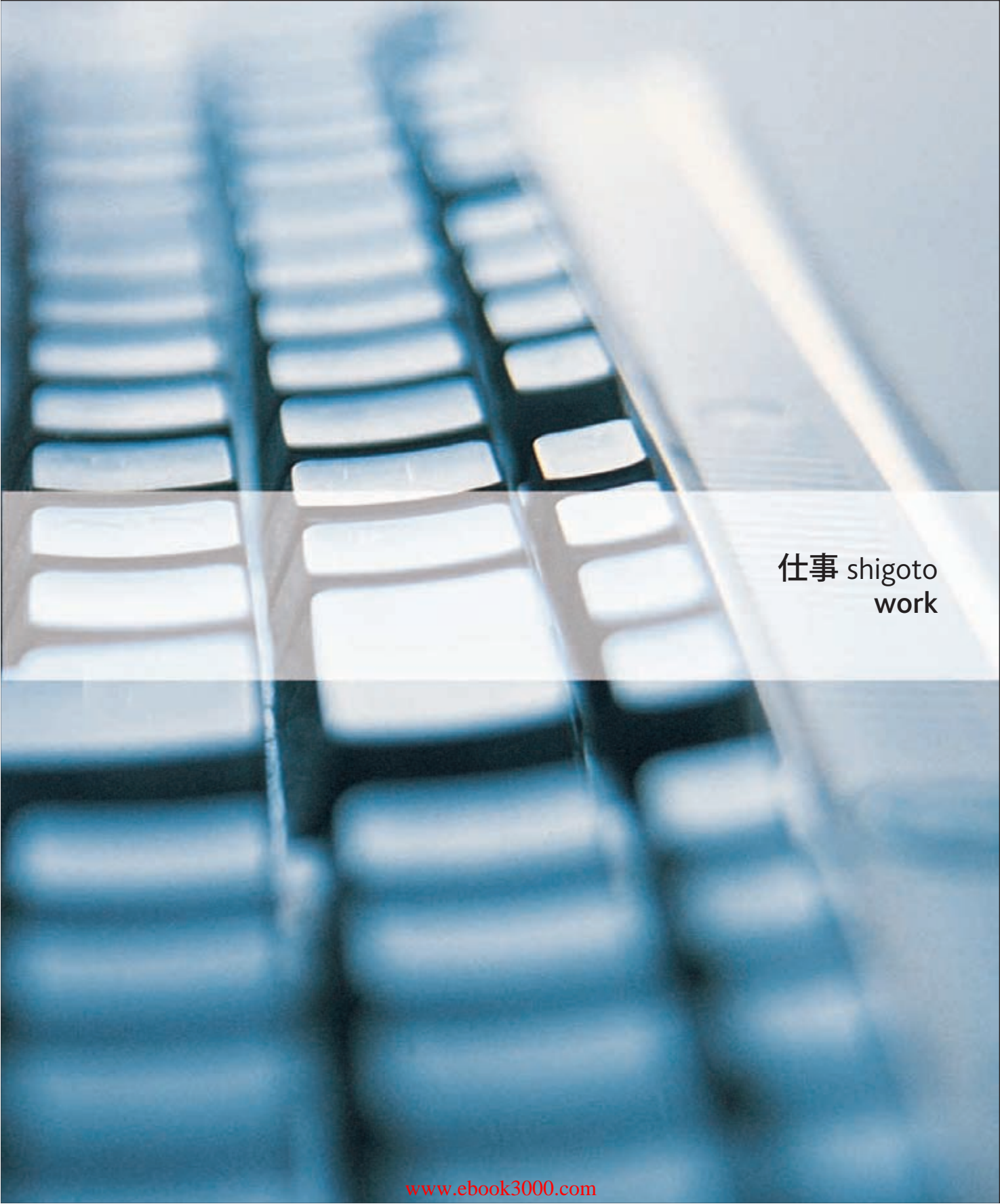

仕事 shigoto  
work

# 事務所1 jimusho • office 1

## 事務所 jimusho • office



## 事務機器 jimū kiki • office equipment

給紙トレイ  
kyūshi torei  
paper tray



プリンタ purinta | printer

用紙ガイド  
yōshi gaido  
paper guide



ファックス fakkusu | fax machine

ファックス  
fakkusu  
fax

### 関連用語 kanrenyōgo • vocabulary

印刷する  
insatsu suru  
print (v)

拡大する  
kakudai suru  
enlarge (v)

複写する  
fukusha suru  
copy (v)

縮小する  
shukushō suru  
reduce (v)

コピーを取らなければなりません。  
kopī o toranakereba narimasen.  
I need to make some copies.

事務用品 jimū yōhin • office supplies



謹呈スリップ  
kintei surippu  
notecard

レターヘッド  
retāheddo  
letterhead



封筒  
fūtō  
envelope

箱型ファイル  
hako-gata fairu  
file box



仕切りカード  
shikiri kādo  
divider



クリップボード  
kurippubōdo  
clipboard



ノート  
nōto  
notepad



インデックス  
indekkusu  
tab

吊り下げ式フォルダー  
tsurisage-shiki forudā  
hanging file



ドキュメントファイル  
dokyumento fairu  
accordion file

レバーアーチ式ファイル  
rebā'āchi-shiki fairu  
binder



システム手帳  
shisutemu techō  
personal organizer

(ホチキスの) 針  
(hochikisu no) shin  
staples



ホチキス  
hochikisu  
stapler

セロテープ  
serotēpu  
sticky tape

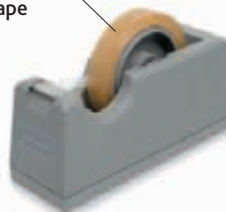

テープカッター  
tēpu kattā  
tape dispenser



穴あけパンチ  
ana'ake panchi  
hole punch

スタンプ台  
sutampu dai  
ink pad



ゴム印  
gomuin  
rubber stamp



輪ゴム  
wagomu  
rubber band



目玉クリップ  
medama kurippu  
bulldog clip



ゼムクリップ  
zemu kurippu  
paper clip

画鋏  
gabyō  
push pin



掲示板 keijiban | bulletin board



# 事務所2 jimusho • office 2

フリップチャート  
furippu chāto  
flipchart

議事録  
gijiroku  
minutes

イーゼル  
izeru  
easel

報告書  
hōkokusho  
report

マネージャー  
manējā  
manager

提案書  
teian sho  
proposal

幹部  
kambu  
executive



会議 kaigi | meeting

## 関連用語 kanrenyōgo • vocabulary

会議室  
kaigi shitsu  
meeting room

出席する  
shusseki suru  
attend (v)

議題  
gidai  
agenda

議長を務める  
gichō o tsutomeru  
chair (v)

会議は何時ですか。  
kaigi wa nanji desuka?  
What time is the meeting?

営業時間は何時から何時までですか。  
eigyōjikan wa nanji kara nanji made desuka?  
What are your office hours?

プロジェクター  
purojekutā  
projector

プレゼンター  
purezentā  
speaker



プレゼンテーション purezentēshon | presentation

# ビジネス bijinesu • business

ノートパソコン  
nōtopasokon  
laptop

メモ  
memo  
notes

ビジネスマン  
bijinesuman  
businessman

ビジネスウーマン  
bijinesu'ūman  
businesswoman



ビジネスランチ bijinesu ranchi | business lunch



出張 shutchō | business trip



手帳 techō | diary

取引先  
torihikisaki  
client

予定  
yotei  
appointment

電子手帳  
denshitechō  
electronic diary



商取引 shōtorihiki | business deal

社長  
shachō  
CEO

## 関連用語 kanrenyōgo • vocabulary

会社  
kaisha  
company

従業員  
jūgyōin  
staff

経理部  
keiri bu  
accounts department

法務部  
hōmu bu  
legal department

本社  
honsha  
headquarters

給料  
kyūryō  
salary

市場開発部  
shijōkaihatsu bu  
marketing department

顧客サービス部  
kōkyaku sābisu bu  
customer service department

支社  
shisha  
regional office

従業員名簿  
jūgyōin meibo  
payroll

営業部  
eigyō bu  
sales department

人事部  
jinji bu  
human resources department

# コンピュータ kompyūta • computer



**関連用語 kanrenyōgo • vocabulary**

|                             |  |  |
|-----------------------------|--|--|
| メモリ<br>memori<br>memory     | ソフト<br>sofuto<br>software              | サーバー<br>sābā<br>server                 |
| RAM<br>ramu<br>RAM          | アプリケーション<br>apurikēshon<br>application | ポート<br>pōto<br>port                    |
| バイト<br>baito<br>bytes       | プログラム<br>puroguramu<br>program         | プロセッサ<br>purosesa<br>processor         |
| システム<br>shisutemu<br>system | ネットワーク<br>nettowāku<br>network         | 電源ケーブル<br>dengen kēburu<br>power cable |



ディスク disuku | disk



ノートパソコン nōtopasokon laptop



ハードドライブ hādo doraibu hard drive

モデム modemu modem



## デスクトップ desukutoppu ・ desktop

メニューバー  
menyūbā  
menubar

ツールバー  
tsūrubā  
toolbar

壁紙  
kabegami  
wallpaper

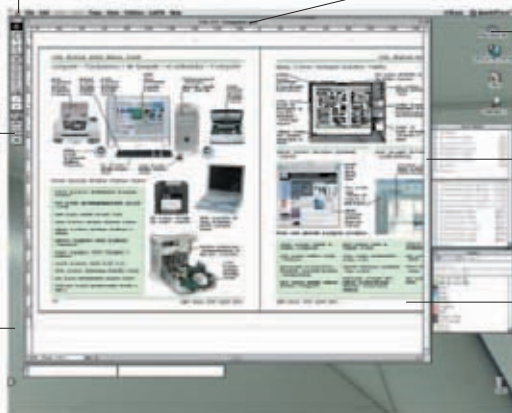

フォント  
fonto  
font

アイコン  
aikon  
icon

スクロールバー  
sukurōrubā  
scrollbar

ウィンドウ  
windo-u  
window



ファイル  
fairu  
file

フォルダ  
foruda  
folder

ごみ箱  
gomibako  
trash

## インターネット intānetto ・ internet

## 電子メール denshimēru ・ email



ブラウザ  
burauza  
browser

受信箱  
jushin-bako  
inbox

ウェブサイト  
webusaito  
website

メールアドレス  
mēru adoresu  
email address

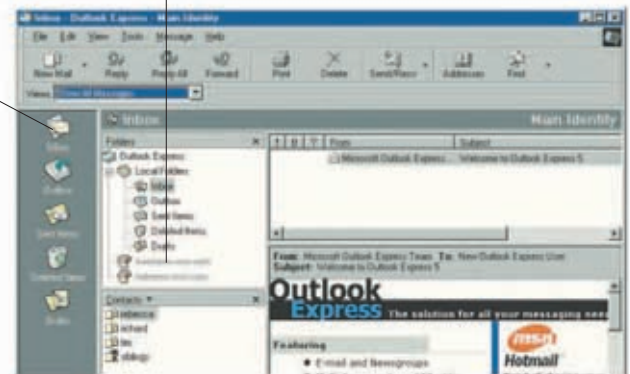

閲覧する etsuran suru | browse (v)

### 関連用語 kanrenyōgo ・ vocabulary

接続する  
setsuzoku suru  
connect (v)

サービスプロバイダ  
sābisu purobaida  
service provider

ログオンする  
roguon suru  
log on (v)

ダウンロードする  
daunrōdo suru  
download (v)

送信する  
sōshin suru  
send (v)

保存する  
hozon suru  
save (v)

インストールする  
insutōru suru  
install (v)

メールアドレス  
mēru akaunto  
email account

オンライン  
onrain  
online

添付書類  
tempu shorui  
attachment

受信する  
jushin suru  
receive (v)

検索する  
kensaku suru  
search (v)

# 報道 hōdō • media

## テレビスタジオ terebi sutajio • television studio

司会者  
shikai-sha  
presenter

照明  
shōmei  
light

セット  
setto  
set



カメラ  
kamera  
camera

カメラ台  
kamera dai  
camera crane

カメラマン  
kameraman  
cameraman

### 関連用語 kanrenyōgo • vocabulary

チャンネル  
channeru  
channel

ニュース  
nyūsu  
news

新聞  
shimbun  
press

連続ドラマ  
renzoku dorama  
soap

アニメ  
anime  
cartoon

ライブ  
raibu  
live

番組制作  
bangumi seisaku  
programming

ドキュメンタリー  
dokyumentarī  
documentary

シリーズ番組  
shirīzu bangumi  
television series

ゲーム番組  
gēmu bangumi  
game show

録画  
rokuga  
prerecorded

放送する  
hōsō suru  
broadcast (v)



インタビュアー intabyuā | interviewer



レポーター repōtā | reporter



テロップ teroppu | teleprompter



ニュースキャスター nyūsukyasutā | news anchor



俳優 haiyū | actors



ブームマイク būmumaiku | sound boom



カチンコ kachinko | clapper board



映画のセット eiga no setto | film set

## ラジオ rajio • radio

調整卓  
chōsei taku  
mixing desk

マイク  
maiku  
microphone

サウンドエンジニア  
saundo enjinia  
sound technician



録音スタジオ rokuon sutajio | recording studio

## 関連用語 kanrenyōgo • vocabulary

ラジオ局  
rajio kyoku  
radio station

中波  
chūha  
medium wave

放送  
hōsō  
broadcast

周波数  
shūhasū  
frequency

波長  
hachō  
wavelength

音量  
onryō  
volume

長波  
chōha  
long wave

合わせる  
awaseru  
tune (v)

短波  
tampa  
short wave

ディスクジョッキー  
disuku jocki  
DJ



# 法律 hōritsu • law

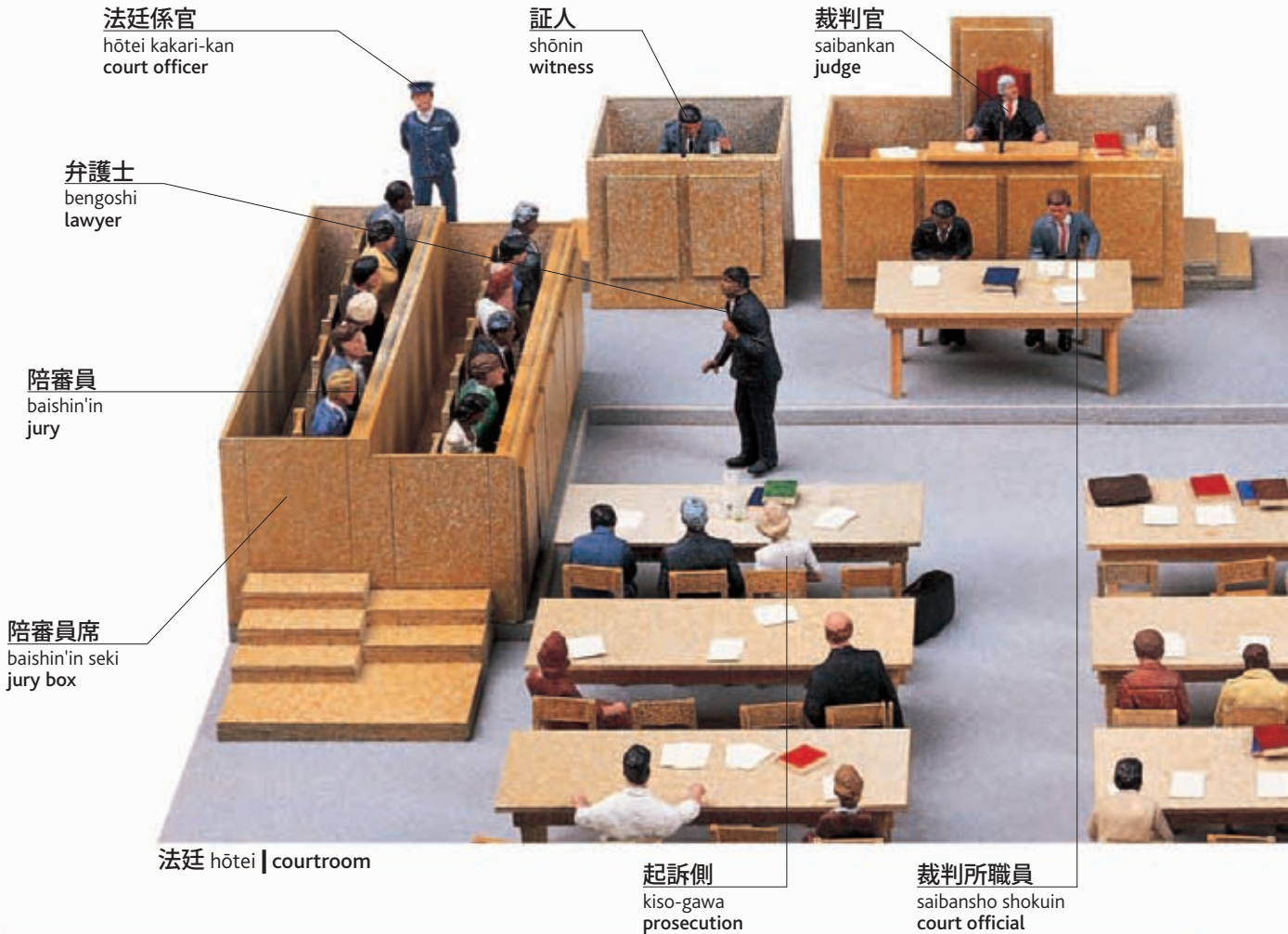

## 関連用語 kanrenyōgo • vocabulary

法律事務所  
hōritsu jimusho  
lawyer's office

呼出し状  
yobidashijō  
summons

命令  
meirei  
writ

訴訟案件  
soshō anken  
court case

法律相談  
hōritsu sōdan  
legal advice

陳述書  
chinjutsu-sho  
statement

公判日  
kōhan-bi  
court date

罪状  
zaijō  
charge

クライアント  
kuraianto  
client

令状  
reijō  
warrant

罪状認否  
zaijōnimpi  
plea

被疑者  
higisha  
accused

速記者  
sokki-sha  
stenographer



容疑者  
yōgisha  
suspect



モンタージュ写真 montāju  
shashin | composite

犯罪者  
hanzai-sha  
criminal



犯罪歴 hanzai-reki  
criminal record

被告人  
hikokunin  
defendant



被告側  
hikoku-gawa  
defense



看守 kanshu | prison guard



監房 kambō | cell



刑務所 keimusho | prison

関連用語 kanrenyōgo • vocabulary

証拠  
shōko  
evidence

有罪  
yūzai  
guilty

保釈金  
hoshakukin  
bail

弁護士に会わせてください。  
bengoshi ni awasete kudasai  
I want to see a lawyer.

判決  
hanketsu  
verdict

無罪  
muzai  
acquitted

上訴  
jōso  
appeal

裁判所はどこですか。  
saibansho wa doko desuka?  
Where is the courthouse?

無実  
mujitsu  
innocent

刑罰  
keibatsu  
sentence

仮釈放  
karishakuho  
parole

保釈金を払えますか。  
hoshakukin o haraemasuka?  
Can I post bail?



# 農場1 nōjō • farm 1



農夫  
nōfu  
farmer

菜園  
saien  
vegetable garden

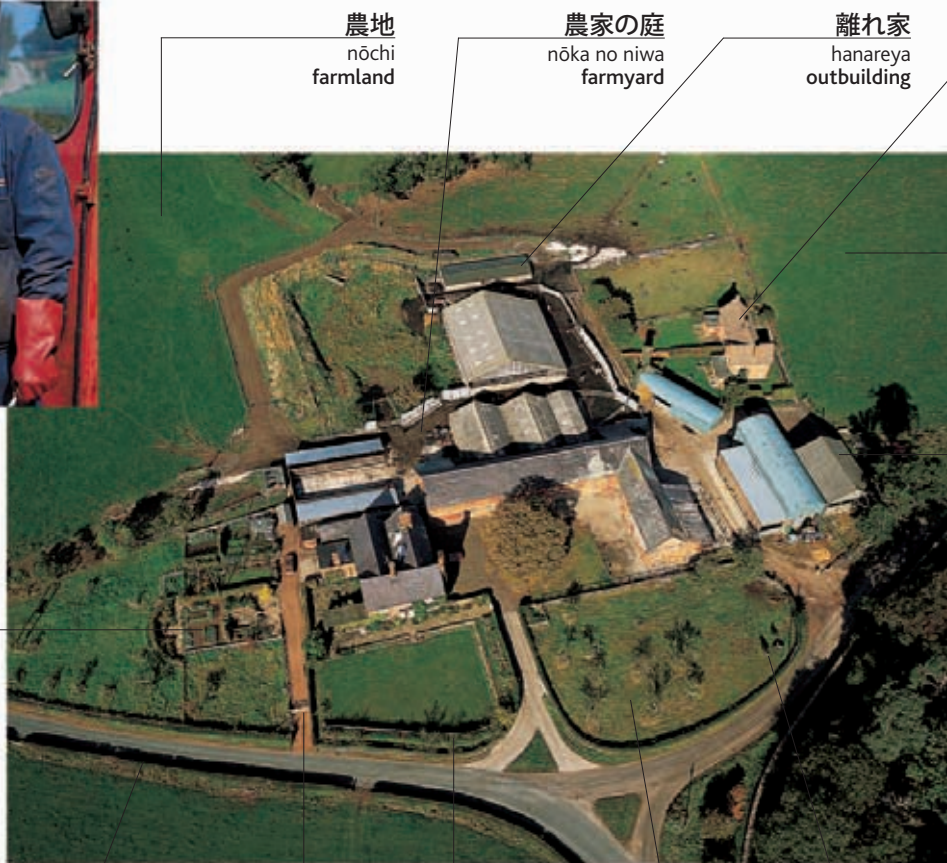

トラクター torakutā | tractor



耕運機  
kō'unki  
cultivator

コンバイン kombain | combine



## 農場の種類 nōjō no shurui • types of farm

作物  
sakumotsu  
crop



耕作農場  
kōsaku nōjō  
crop farm



酪農場  
rakunōjō  
dairy farm

羊の群れ  
hitsuji no mure  
flock



牧羊農場  
bokuyō nōjō  
sheep farm



養鶏場 yōkeijō  
poultry farm

葡萄の木  
budō no ki  
vine



葡萄園  
budōen  
vineyard



養豚場  
yōtonjō  
pig farm



養魚場  
yōgyōjō  
fish farm



果樹園  
kajuen  
fruit farm

## 業務 gyōmu • actions

畦  
aze  
furrow



耕す  
tagayasu  
plow (v)



種を蒔く  
tane o maku  
sow (v)



乳を搾る  
chichi o shiboru  
milk (v)

餌を与える  
esa o ataeru  
feed (v)



水を引く mizu o hiku  
water (v)



刈り入れる kari'ireru  
harvest (v)

### 関連用語 kanrenyōgo • vocabulary

除草剤  
josōzai  
herbicide

群れ  
mure  
herd

かえば桶  
kaibaoke  
trough

殺虫剤  
satchūzai  
pesticide

サイロ  
sairo  
silo

植える  
ueru  
plant (v)

# 農場2 nōjō • farm 2

## 作物 sakumotsu • crops



小麦  
komugi  
wheat



トウモロコシ  
tōmorokoshi  
corn



大麦  
ōmugi  
barley



菜種  
natane  
rapeseed



向日葵  
himawari  
sunflower



俵  
tawara  
bale

干し草  
hoshikusa  
hay



アルファルファ  
arufarufa  
alfalfa



煙草  
tabako  
tobacco



米  
kome  
rice



茶  
cha  
tea



コーヒー  
kōhī  
coffee



亜麻  
ama  
flax



砂糖黍  
satōkibi  
sugarcane



綿花  
menka  
cotton



かかし  
kakashi  
scarecrow



家畜 kachiku • livestock

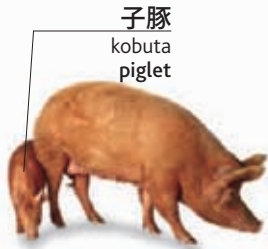

子豚  
kobuta  
piglet

豚  
buta  
pig



子牛  
ko-ushi  
calf

雌牛  
meushi  
cow



雄牛  
o-ushi  
bull



羊  
hitsuji  
sheep



子羊  
kohitsuji  
lamb



子山羊  
koyagi  
kid

山羊  
yagi  
goat



子馬  
ko-uma  
foal

馬  
uma  
horse



驢馬  
roba  
donkey

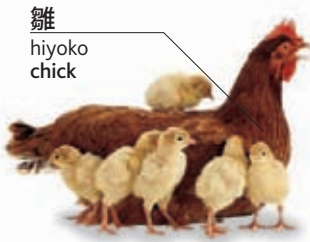

雛  
hiyoko  
chick

鶏  
niwatori  
chicken



雄鶏  
ondori  
cockerel



七面鳥  
shichimenchō  
turkey



子鴨  
kogamo  
duckling

鴨  
kamo  
duck



馬屋  
umaya  
stable



畜舎  
chikusha  
pen



鳥小屋  
torigoya  
chicken coop



豚小屋  
butagoya  
pigsty



# 建設 kensetsu • construction

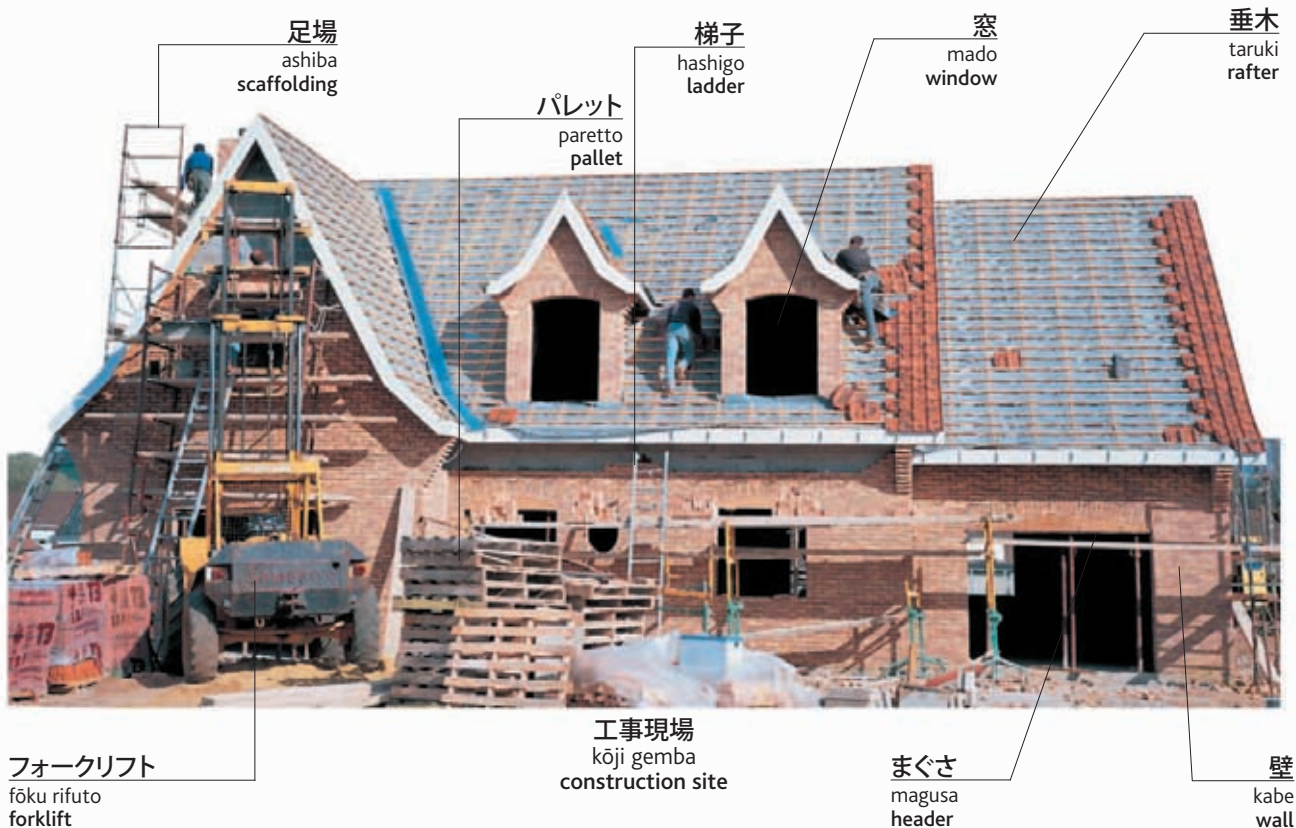

建築材料 kenchiku zairyō • materials



煉瓦  
renga  
brick



材木  
zaimoku  
lumber



屋根瓦  
yane-gawara  
roof tile



コンクリートブロック  
konkurīto burokku  
concrete block

道具 dōgu • tools

モルタル  
morutaru  
mortar



こて  
kote  
trowel



水平器  
suiheiki  
level



大ハンマー  
ōhanmā  
sledgehammer

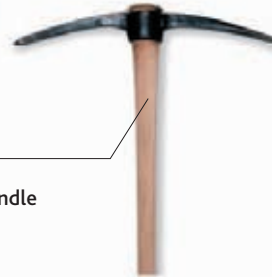

つるはし  
tsuruhashi  
pickax



スコップ  
sukoppu  
shovel

柄  
e  
handle

機械 kikai • machinery



ローラー  
rōrā  
roller



ダンプカー  
dampukā  
dump truck



フック  
fukku  
hook

クレーン車 kurēn-sha | crane

アウトリガー  
autorigā  
support

道路工事 dōro kōji • roadwork

タールマック  
tārumakku  
asphalt

三角コーン  
sankaku-kōn  
cone



空気ドリル  
kūki-doriru  
pneumatic drill



再舗装  
saihosō  
resurfacing

掘削機  
kussakuki  
excavator



# 職業1 shokugyō • occupations 1



大工  
daiku  
carpenter



電気工  
denkikō  
electrician



配管工  
haikankō  
plumber



建築屋  
kenchiku-ya  
construction worker



庭師  
niwashi  
gardener



掃除機  
sōjiki  
vacuum  
cleaner

掃除夫  
sōjifu  
cleaner



修理工  
shūrikō  
mechanic



肉屋  
nikuya  
butcher



鉋  
hasami  
scissors

美容師  
biyōshi  
hair stylist



魚屋  
sakanaya  
fishmonger



八百屋  
yaoya  
greengrocer



花屋  
hanaya  
florist



床屋  
tokoya  
barber



宝石商  
hōseki-shō  
jeweler



店員  
ten'in  
shop clerk





不動産屋  
fudōsan-ya  
real estate agent



眼鏡屋  
megane-ya  
optician



歯医者  
haisha  
dentist



医者  
isha  
doctor

マスク  
masuku  
mask



薬剤師  
yakuzaishi  
pharmacist



看護婦  
kangofu  
nurse



獣医  
jūi  
veterinarian



農夫  
nōfu  
farmer



漁師  
ryōshi  
fisherman



マシンガン  
mashin-gan  
machine gun



警官  
keikan  
policeman

名札  
nafuda  
identity badge



警備員  
keibi'in  
security guard

制服  
seifuku  
uniform



船員  
sen'in  
sailor



消防士  
shōbōshi  
firefighter

# 職業2 shokugyō • occupations 2



弁護士  
bengoshi  
lawyer



会計士  
kaikeishi  
accountant



建築家 kenchikuka | architect

模型  
mokei  
model



科学者  
kagakusha  
scientist



教師  
kyōshi  
teacher



司書  
shisho  
librarian



受付係  
uketsuke gakari  
receptionist



郵便鞆  
yūbin kaban  
mailbag

郵便配達  
yūbinhaitatsu  
mail carrier



バスの運転手  
basu no untenshu  
bus driver



トラックの運転手  
torakku no untenshu  
truck driver



タクシーの運転手  
takushī no untenshu  
taxi driver



パイロット  
pairotto  
pilot



スチュワーデス  
sichuwādesu  
air stewardess



旅行代理店の社員  
ryokō dairiten no shain  
travel agent

シェフの帽子  
shefu no bōsh  
chef's hat



シェフ  
shefu  
chef





チュチュ  
chuchu  
tutu

音楽家  
ongakuka  
musician



ダンサー  
dansā  
dancer



俳優  
haiyū  
actor



歌手  
kashu  
singer



ウェイトレス  
weitoresu  
waitress



バーテン  
bāten  
bartender



スポーツマン  
supōtsuman  
athlete



彫刻家  
chōkokuka  
sculptor



画家  
gaka  
painter



写真家  
shashinka  
photographer



ニュースキャスター  
nyūskyasutā  
news anchor



メモ  
memo  
notes

ジャーナリスト  
jānarisuto  
journalist

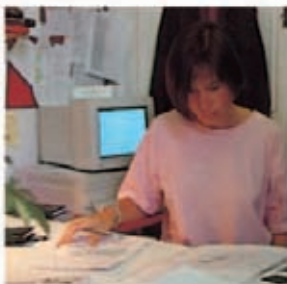

編集者  
henshū-sha  
editor



デザイナー  
dezainā  
designer



針子  
hariko  
seamstress



仕立屋  
shitateya  
tailor









交通 kōtsū  
transportation

# 道路 dōro • roads

高速道路  
kōsoku dōro  
highway

料金所  
ryōkin-jo  
toll booth

路面標識  
romen hyōshiki  
road markings

出入路  
shutsunyū-ro  
on-ramp

一方通行  
ippōt-sūkō  
one-way

分岐帯  
bunki-tai  
divider

ジャンクション  
jankushon  
junction

信号  
shingō  
traffic light

トラック  
torakku  
truck

中央分離帯  
chūō bunri-tai  
median

走行車線  
sōkō shasen  
inside lane

中央車線  
chūō shasen  
middle lane

追い越し車線  
oikoshi shasen  
outside lane

出口ランプ  
deguchi rampu  
exit ramp

交通  
kōtsū  
traffic

高架道路  
kōka dōro  
overpass

路肩  
rokata  
hard shoulder

ガード下通路  
gādo shita tsūro  
underpass





横断歩道  
ōdan hodō  
pedestrian crossing



緊急電話  
kinkyū denwa  
emergency phone



身体障害者用駐車スペース  
shintai shōgaisha-yō  
chūsha supēsu  
disabled parking



交通渋滞  
kōtsū jūtai  
traffic jam

地図  
chizu  
map



パーキングメーター  
pākingu mētā  
parking meter



交通巡査  
kōtsū jūnsa  
traffic police officer

関連用語 kanrenyōgo • vocabulary

環状交差点  
kanjō kōsaten  
traffic circle

往復分離道路  
ōfuku bunri dōro  
divided highway

追い越す  
oikosu  
pass (v)

迂回路  
ukairo  
diversion

駐車する  
chūsha suru  
park (v)

レッカー移動  
rekka idō  
tow away (v)

道路工事  
dōro kōji  
roadwork

運転する  
unten suru  
drive (v)

これは...へ行く道ですか。  
kore wa ... e iku  
michi desuka?  
Is this the road to...?

ガードレール  
gādo rēru  
crash barrier

バックする  
baku suru  
back up (v)

どこに駐車できますか。  
dokoni chūsha dekimasuka?  
Where can I park?

道路標識 dōro hyōshiki • road signs



進入禁止  
shinnyū kinshi  
do not enter



制限速度  
seigen sokudo  
speed limit



危険  
kiken  
hazard



停車禁止  
teisha kinshi  
no stopping



右折禁止  
jusetsu kinshi  
no right turn

# バス basu • bus

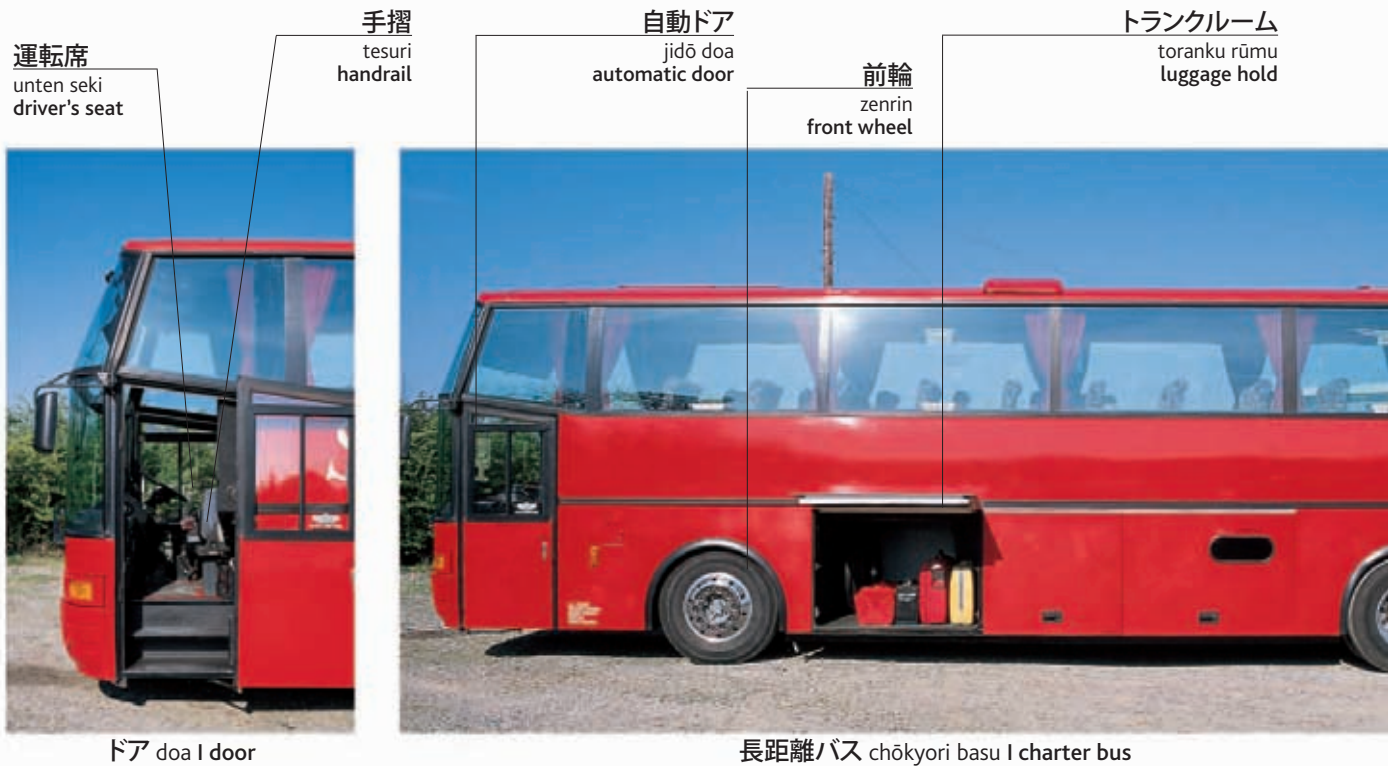

## バスの種類 basu no shurui • types of buses







後輪  
kōrin  
rear wheel

窓  
mado  
window

停車ボタン  
teisha botan  
stop button



乗車券  
jōshaken  
bus ticket



ベル  
beru  
bell



バスターミナル  
basu tāminaru  
bus station



バス停  
basu-tei  
bus stop

関連用語 kanrenyōgo • vocabulary

料金  
ryōkin  
fare

車椅子対応  
kurumaisu taiō  
wheelchair access

時刻表  
jikokuhyō  
timetable

バス待合所  
basu machiai-jo  
bus shelter

...で停まりますか。  
... de tomarimasuka?  
Do you stop at...?

...へ行くのは、どのバスですか。  
... e ikunowa dono basu desuka?  
Which bus goes to...?



マイクロバス  
maikuro basu  
minibus



観光バス kankō basu | tourist bus



シャトルバス shatoru basu | shuttle bus



# 自動車1 jidōsha • car 1

## 外装 gaisō • exterior



## 車の種類 kuruma no shurui • types



コンパクトカー  
kompakuto kā  
compact



ハッチバック  
hatchibakku  
hatchback



セダン  
sedan  
sedan



ステーションワゴン  
sutēshonwagon  
station wagon



オープンカー  
ōpun kā  
convertible



スポーツカー  
supōtsu kā  
sports car



ワンボックスカー  
wambokkusu kā  
minivan



四輪駆動車  
yonrin kudōsha  
four-wheel drive



クラシックカー  
kurashikku kā  
vintage



リムジン  
rimujin  
limousine

ガソリンスタンド gasorin sutando  
• gas station

ガソリンポンプ  
gasorin pompu  
pump

価格  
kakaku  
price



給油場  
kyūyūjō  
forecourt

給気装置  
kyūki sōchi  
air supply

## 関連用語 kanrenyōgo • vocabulary

オイル  
oiru  
oil

有鉛  
yūen  
leaded

洗車  
sensha  
car wash

ガソリン  
gasorin  
gasoline

ディーゼル  
dīzeru  
diesel

不凍剤  
futōzai  
antifreeze

無鉛  
muen  
unleaded

整備工場  
seibi kōjō  
garage

フロントガラス洗浄液  
furon-to-garasu senjōeki  
windshield wash

満タンお願いします。  
mantan onegaishimasu.  
Fill the tank, please.

# 自動車 2 jidōsha • car 2

## 内装 naisō • interior

後部座席  
kōbu zaseki  
back seat

アームレスト  
āmu resuto  
armrest

ヘッドレスト  
heddo resuto  
headrest

ドアロック  
doa rokku  
door lock

ドアハンドル  
doa handoru  
handle



### 関連用語 kanrenyōgo • vocabulary

ツードア  
tsū doa  
two-door

フォードア  
fō doa  
four-door

オートマ  
ōtoma  
automatic

ブレーキ  
burēki  
brake

アクセル  
akuseru  
accelerator

スリードア  
surī doa  
three-door

マニュアル  
manyuaru  
manual

イグニッション  
igunisshon  
ignition

クラッチ  
kuratchi  
clutch

エアコン  
eakon  
air conditioning

...への行き方を教えてください。  
... eno ikikata o oshiete kudasai?  
Can you tell me the way to...?

駐車場はどこですか。  
chūshajō wa doko desuka?  
Where is the parking lot?

ここに駐車できますか。  
kokoni chūsha dekimasuka?  
Can I park here?



## 操作系 sōsakei • controls

**ハンドル**  
handoru  
steering  
wheel

**クラクション**  
kurakushon  
horn

**ダッシュボード**  
dasshubōdo  
dashboard

**ハザードランプ**  
hazādo rampu  
hazard lights

**カーナビ**  
kānabi  
satellite navigation



左ハンドル hidari handoru | left-hand drive

**水温計**  
suionkei  
temperature gauge

**カーオーディオ**  
kā ōdio  
car stereo

**ヒーター調節**  
hitā chōsetsu  
heater controls

**変速レバー**  
hensoku rebā  
gearshift

**タコメーター**  
takomētā  
tachometer



右ハンドル migi handoru | right-hand drive

**速度計**  
sokudokei  
speedometer

**燃料計**  
nenryōkei  
fuel gauge

**ライトスイッチ**  
raito suitchi  
lights switch

**オドメーター**  
odomētā  
odometer

**エアバッグ**  
eabaggu  
air bag

# 自動車 3 jidōsha • car 3

## 機械構造 kikaikōzō • mechanics

フロントガラス洗浄液タンク  
furonto-garasu senjōeki tanku  
windshield fluid reservoir

オイルゲージ  
oiru gēji  
dipstick

エアフィルター  
ea firutā  
air filter

ブレーキフルードタンク  
burēki furūdo tanku  
brake fluid reservoir

バッテリー  
batterī  
battery



車体  
shatai  
body

冷却液タンク  
reikyakueki tanku  
coolant reservoir

シリンダーヘッド  
shirindā heddo  
cylinder head

管  
kan  
pipe

サンルーフ  
sanrūfu  
sunroof

ラジエーター  
rajiētā  
radiator

ファン  
fan  
fan

エンジン  
enjīn  
engine

ホイールキャップ  
hoīru kyappu  
hubcap

ギアボックス  
gia bokkusu  
gearbox

変速機  
hensoku-ki  
transmission

駆動軸  
kudōjiku  
driveshaft

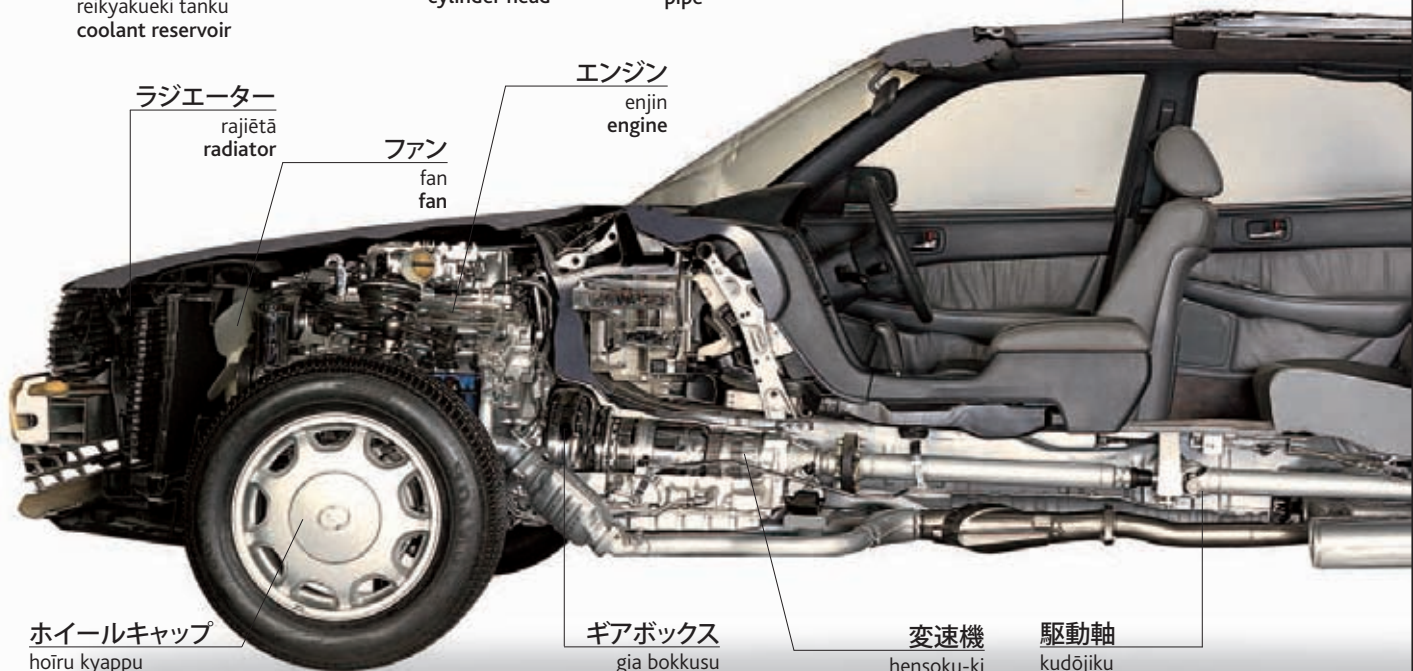

## パンク panku • puncture

スペアタイヤ  
supea taiya  
spare tire

レンチ  
renchi  
tire iron

ホイールナット  
hoīru natto  
lug nuts

ジャッキ  
jakki  
jack

タイヤを交換する  
taiya o kōkan suru  
change a tire (v)

屋根  
yane  
roof

サスペンション  
sasupenshon  
suspension

マフラー  
mafurā  
muffler

排気管  
haiki-kan  
exhaust pipe

## 関連用語 kanrenyōgo • vocabulary

自動車事故  
jidōsha jiko  
car accident

故障  
koshō  
breakdown

保険  
hoken  
insurance

牽引車  
ken'insha  
tow truck

修理工  
shūrikō  
mechanic

タイヤ空気圧  
taiya kūkiatsu  
tire pressure

ヒューズボックス  
hyūzu bokkusu  
fuse box

スパークプラグ  
supāku puragu  
spark plug

ファンベルト  
fam beruto  
fan belt

燃料タンク  
nenryō tanku  
gas tank

タイミング  
taimingu  
timing

ターボチャージャー  
tābochājā  
turbocharger

配電器  
haidenki  
distributor

シャシー  
shashī  
chassis

ハンドブレーキ  
handoburēki  
handbrake

オルタネーター  
orutanēta  
alternator

カムベルト  
kamu beruto  
cam belt

車が故障しました。  
kuruma ga koshō shimashita.  
I've broken down.

車がスタートしません。  
kuruma ga sutāto shimasen.  
My car won't start.

修理はできますか。  
shūri wa dekimasuka?  
Do you do repairs?

エンジンがオーバーヒートしています。  
enjin ga obāhīto shite imasu.  
The engine is overheating.



# オートバイ ōtobai • motorcycle

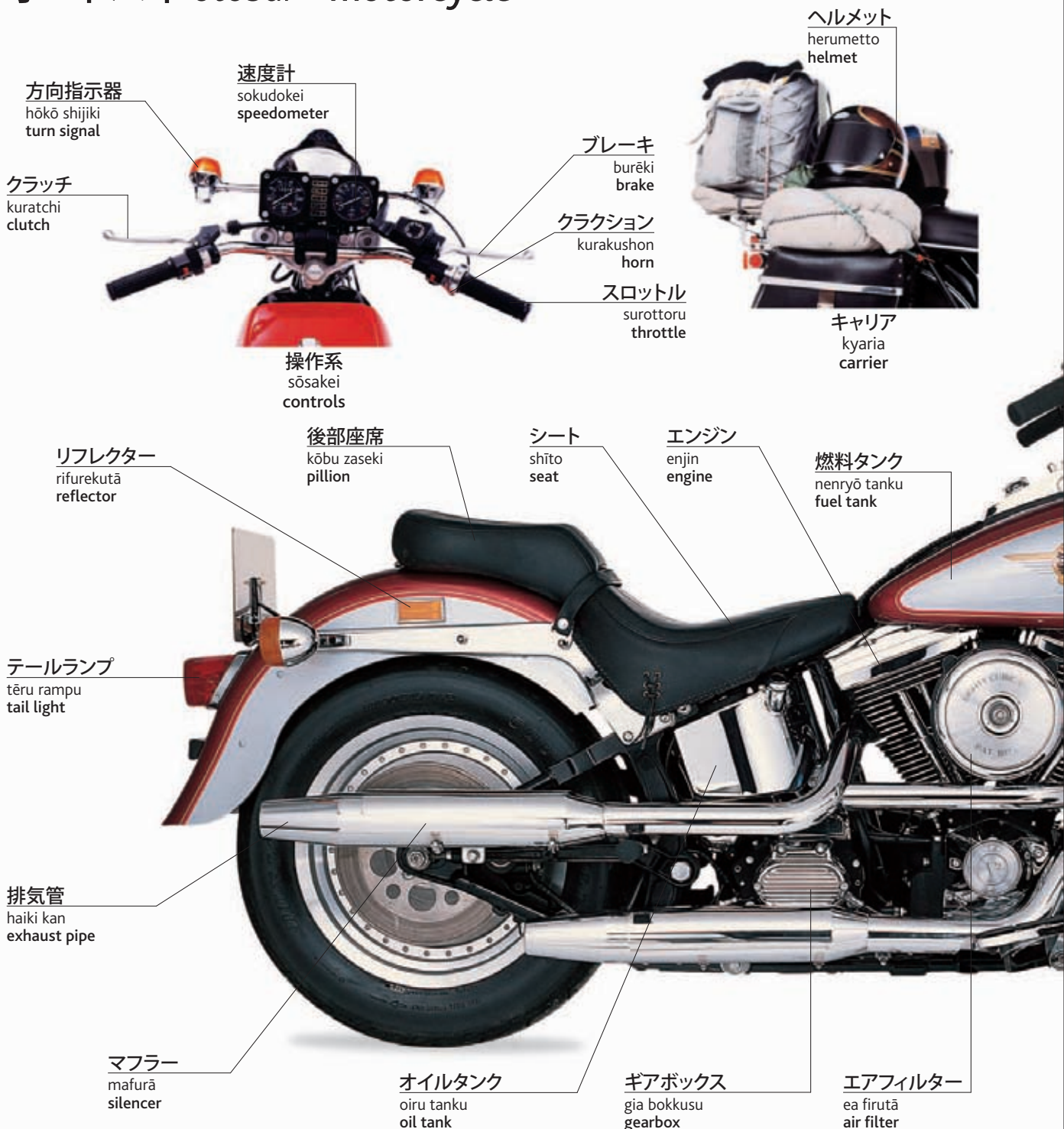

種類 shurui • types

バイザー  
baizā  
visor

革ジャン  
kawajan  
leathers

反射材  
hanshazai  
reflector strap

膝当て  
hiza'ate  
knee pad



バイクウエア baiku uea | clothing

ヘッドライト  
heddo raito  
headlight

サスペンション  
sasupenshon  
suspension

泥除け  
doroyoke  
mudguard

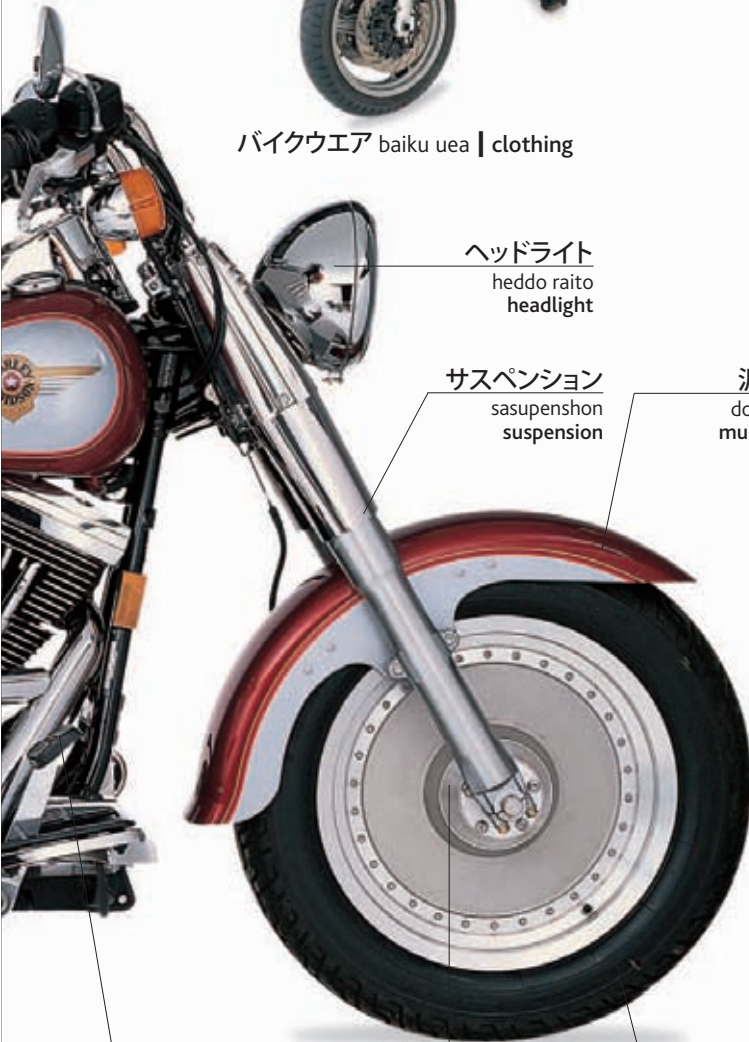

ブレーキペダル  
burēki pedaru  
brake pedal

アクスル  
akusuru  
axle

タイヤ  
taiya  
tire



レーシングバイク rēshingu baiku | racing bike

ウインドシールド  
uindo-shīrudo  
windshield



ツアラー tsuarā | tourer



ダートバイク dāto baiku | dirt bike

スタンド  
sutando  
stand



スクーター sukūtā | scooter



# 自転車 jitensha • bicycle



タンデム自転車 tandemu jitensha  
tandem



ロードレーサー  
rôdo rēsā  
racing bike



マウンテンバイク  
maunten baiku  
mountain bike



ツーリング自転車  
tsūringu jitensha  
touring bike



ロードバイク  
rôdo baiku  
road bike

サドル  
sadoru  
saddle

シートピラー  
shīto pirā  
seat post

水筒  
suitō  
water bottle

フレーム  
furēmu  
frame

ブレーキ  
burēki  
brake

ハブ  
habu  
hub

変速機  
hensoku-ki  
gears

リム  
rimu  
rim

タイヤ  
taiya  
tire

チェーン  
chēn  
chain

ペダル  
pedaru  
pedal

コグ  
kogu  
cog

ヘルメット  
herumetto  
helmet



自転車道 jitensha-dō | bicycle lane





関連用語 kanrenyōgo • vocabulary

|                                    |                                      |  |                           |  |  |
|------------------------------------|--------------------------------------|--|---------------------------|--|--|
| ライト<br>raito<br>lamp               | スタンド<br>sutando<br>kickstand         | ブレーキパッド<br>burēki paddo<br>brake block | 籠<br>kago<br>basket       | トウクリップ<br>to-u kurippu<br>toe clip     | ブレーキをかける<br>burēki o kakeru<br>brake (v) |
| テールライト<br>tēru raito<br>rear light | 自転車ラック<br>jitensha raku<br>bike rack | ケーブル<br>kēburu<br>cable                | ダイナモ<br>dainamo<br>dynamo | トウストラップ<br>to-u sutorappu<br>toe strap | 自転車に乗る<br>jitensha ni noru<br>cycle (v)  |
| リフレクター<br>rifurekutā<br>reflector  | 補助輪<br>hojorin<br>stabilizers        | スプロケット<br>supuroketto<br>sprocket      | パンク<br>panku<br>puncture  | 漕ぐ<br>kogu<br>pedal (v)                | 変速する<br>hensoku suru<br>change gear (v)  |

# 列車 ressha • train

客車  
kyakusha  
car

ホーム  
hōmu  
platform

カート  
kāto  
cart



ホーム番号  
hōmu bangō  
platform number

通勤者  
tsūkinsha  
commuter

駅 eki | train station

## 列車の種類 ressha no shurui • types of train



蒸気機関車  
jōki kikansha  
steam train

エンジン  
enjin  
engine



ディーゼル機関車 dīzeru kikansha | diesel train

運転室  
unten shitsu  
driver's cab

レール  
rēru  
rail



電車  
densha  
electric train



高速列車  
kōsoku ressha  
high-speed train



モノレール  
monorēru  
monorail



地下鉄  
chikatetsu  
subway



路面電車  
romen densha  
tram



貨物列車  
kamotsu ressha  
freight train





客室  
kyakushitsu  
compartment

拡声装置  
kakusei sōchi  
public address system

時刻表  
jikokuhyō  
timetable



切符  
kippu  
ticket

網棚  
amidana  
luggage rack

車窓  
shasō  
window

線路  
senro  
track

扉  
tobira  
door

座席  
zaseki  
seat



改札口 kaisatsu-guchi | ticket gates



食堂車 shokudō-sha | dining car



コンコース konkōsu | concourse



寝台個室  
shindai koshitsu  
sleeping compartment

関連用語 kanrenyōgo • vocabulary

鉄道網  
tetsudō-mō  
rail network

地下鉄路線図  
chikatetsu rosenzu  
subway map

切符売場  
kippu uriba  
ticket office

通電レール  
tsūden rēru  
third rail

インターシティ列車  
intāshiti ressha  
intercity train

遅れ  
okure  
delay

検札員  
kensatsuin  
conductor

信号  
shingō  
signal

新幹線  
shinkansen  
bullet train

料金  
ryōkin  
fare

乗り換える  
norikaeru  
change (v)

非常レバー  
hijō rebā  
emergency lever



# 航空機 kōkūki • aircraft

## 定期旅客機 teiki-ryokakki • airliner



## キャビン kyabin • cabin





熱気球  
netsukikyū  
hot-air balloon



マイクロライト  
maikuroraito  
ultralight



グライダー  
guraidā  
glider



複葉機  
fukuyōki  
biplane

プロペラ  
puropera  
propeller



軽飛行機  
keihikōki  
light aircraft



水上飛行機  
suijō hikōki  
sea plane



自家用ジェット機  
jikayō jettoki  
private jet



超音波ジェット機  
chōompa jettoki  
supersonic jet

ローターブレード  
rōtā burēdo  
rotor blade



ヘリコプター  
herikoputā  
helicopter



爆撃機  
bakugekiki  
bomber



ミサイル  
misairu  
missile

戦闘機  
sentōki  
fighter plane

関連用語 kanrenyōgo • vocabulary

パイロット  
pairotto  
pilot

離陸する  
ririku suru  
takeoff (v)

着陸する  
chakuriku suru  
land (v)

エコノミークラス  
ekonomī kurasu  
economy class

手荷物  
tenimotsu  
hand luggage

副操縦士  
fukusōjūshi  
copilot

飛ぶ  
tobu  
fly (v)

高度  
kōdo  
altitude

ビジネスクラス  
bijinesu kurasu  
business class

シートベルト  
shīto beruto  
seat belt

# 空港 kūkō • airport



定期旅客機 teiki ryokakki | airliner

エプロン  
epuron  
apron

牽引車  
ken'insha  
baggage trailer

ターミナル  
tāminaru  
terminal

作業車  
sagyō-sha  
service vehicle

通路  
tsūro  
walkway

## 関連用語 kanrenyōgo • vocabulary

滑走路  
kassōro  
runway

便名  
binmei  
flight number

カルーセル  
karūseru  
carousel

休暇  
kyūka  
vacation

国際便  
kokusai bin  
international flight

出入国管理  
shutsunyūkoku kanri  
immigration

警備  
keibi  
security

チェックインする  
chekkuin suru  
check in (v)

国内便  
kokunai bin  
domestic flight

税関  
zeikan  
customs

レントゲン検査装置  
rentogen kensa sōchi  
x-ray machine

管制塔  
kanseitō  
control tower

乗り継ぎ  
noritsugi  
connection

超過荷物  
chōka nimotsu  
excess baggage

旅行パンフレット  
ryokō panfuretto  
travel brochure

飛行機を予約する  
hikōki o yoyaku suru  
book a flight (v)



手荷物  
tenimotsu  
hand luggage

荷物  
nimotsu  
luggage

カート  
kâto  
cart



チェックインデスク  
cheku in desuku  
check-in desk



ビザ  
biza  
visa

旅券 ryoken | passport



入国審査  
nyūkoku shinsa  
passport control

搭乗券  
tōjōken  
boarding pass



航空券  
kōkūken  
ticket



出発ロビー  
shuppatsu robī  
departure lounge

ゲート番号  
gēto bangō  
gate number

出発便  
shuppatsu bin  
departures



目的地  
mokutekichi  
destination

到着便  
tōchaku bin  
arrivals

案内板  
annai-ban  
information screen



免税店  
menzeiten  
duty-free shop



荷物引き渡し  
nimotsu hikiwatashi  
baggage claim



タクシー乗り場  
takushī noriba  
cab stand



レンタカー  
rentakā  
car rental

# 船 fune • ship

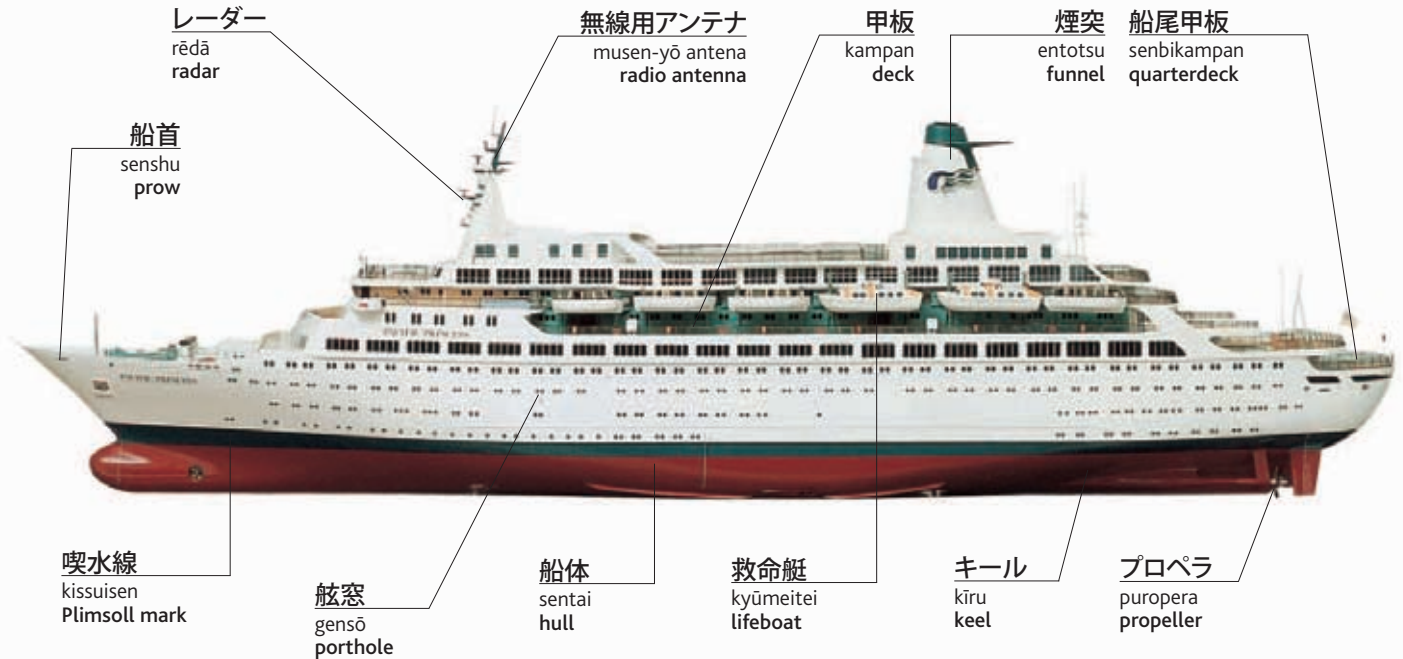

海洋定期船 kaiyō teikisen | ocean liner



船橋  
senkyō  
bridge



機関室  
kikan shitsu  
engine room



船室  
senshitsu  
cabin



調理室  
chōri shitsu  
galley

## 関連用語 kanrenyōgo • vocabulary

ドック  
dokku  
dock

ウィンドラス  
windorasu  
windlass

港湾  
kōwan  
port

船長  
senchō  
captain

舷門  
genmon  
gangway

高速モーターボート  
kōsoku mōtābōto  
speedboat

錨  
ikari  
anchor

ボート  
bōto  
rowboat

係船柱  
keisenchū  
bollard

カヌー  
kanū  
canoe



その他の船舶 sonota no sempaku • other ships



フェリー  
ferī  
ferry



船外機  
sengaiki  
outboard motor

ゴムボート  
gomubōto  
inflatable dinghy



水中翼船  
suichūyoku-sen  
hydrofoil



ヨット  
yotto  
yacht



カタマラン  
katamaran  
catamaran



曳航船  
eikō-sen  
tugboat



ホバークラフト  
hobākurafto  
hovercraft



コンテナ船  
kontena-sen  
container ship



帆船  
hansen  
sailboat

索具  
sakugu  
rigging

船倉  
sensō  
hold



貨物船  
kamotsu-sen  
freighter



石油タンカー  
sekiyu tankā  
oil tanker



航空母艦  
kōkū bokan  
aircraft carrier



戦艦  
senkan  
battleship



展望塔  
tembōtō  
conning tower

潜水艦  
sensuikan  
submarine



# 港湾 kōwan • port

倉庫  
sōko  
warehouse

クレーン  
kurēn  
crane

フォークリフト  
fōkurifuto  
fork-lift

出入道路  
shutsunyū dōro  
access road

税関  
zeikan  
customs house



ドック  
dokku  
dock

コンテナ  
kontena  
container

波止場  
hatoba  
quay

貨物  
kamotsu  
cargo

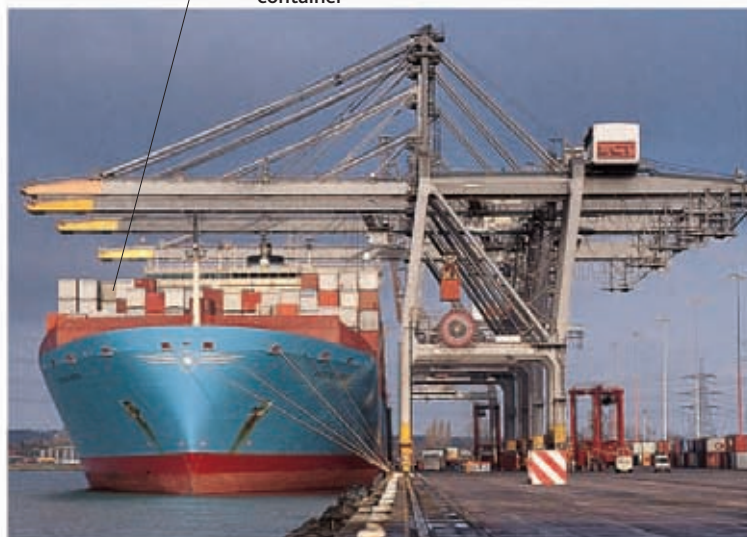

コンテナ港 kontena-kō | container port

フェリー乗り場  
ferī noriba  
ferry terminal

フェリー  
ferī  
ferry

切符売場  
kippu uriba  
ticket office

船客  
senkyaku  
passenger



船客港 senkyaku-kō | passenger port

網  
ami  
net

漁船  
gyosen  
fishing boat

係留索具  
keiryū sakugu  
mooring



漁港 gyokō | fishing port



マリーナ marina | marina



港 minato | harbor



栈橋 sambashi | pier



防波堤  
bōhatei  
jetty



造船所  
zōsen jo  
shipyard



灯台  
tōdai  
lighthouse

ランプ  
rampu  
lamp



ブイ  
bui  
buoy

関連用語 kanrenyōgo • vocabulary

沿岸警備隊  
engan keibitai  
coastguard

港長  
kōchō  
harbour master

錨を下ろす  
ikari o orosu  
drop anchor (v)

乾ドック  
kandokku  
dry dock

係留する  
keiryū suru  
moor (v)

波止場につける  
hatoba ni tsukeru  
dock (v)

乗船する  
jōsen suru  
board (v)

下船する  
gesen suru  
disembark (v)

出港する  
shukkō suru  
set sail (v)





PRESSION

ULTRA  
3

DUNLOP  
DDH III  
4

DUNLOP

TOUR  
EDITION  
1

ProStaff  
4

RANCHO SPRINGS  
GOLF CLUB

TOP-FLITE  
HOT XL  
4

ProStaff  
4

RAM TOUR  
1

MAXFLI  
1

DISTANCE

TOP-FLITE  
STRATA  
3

ProStaff





スポーツ supōtsu  
sports

# アメリカンフットボール amerikan futtobōru

## • American football

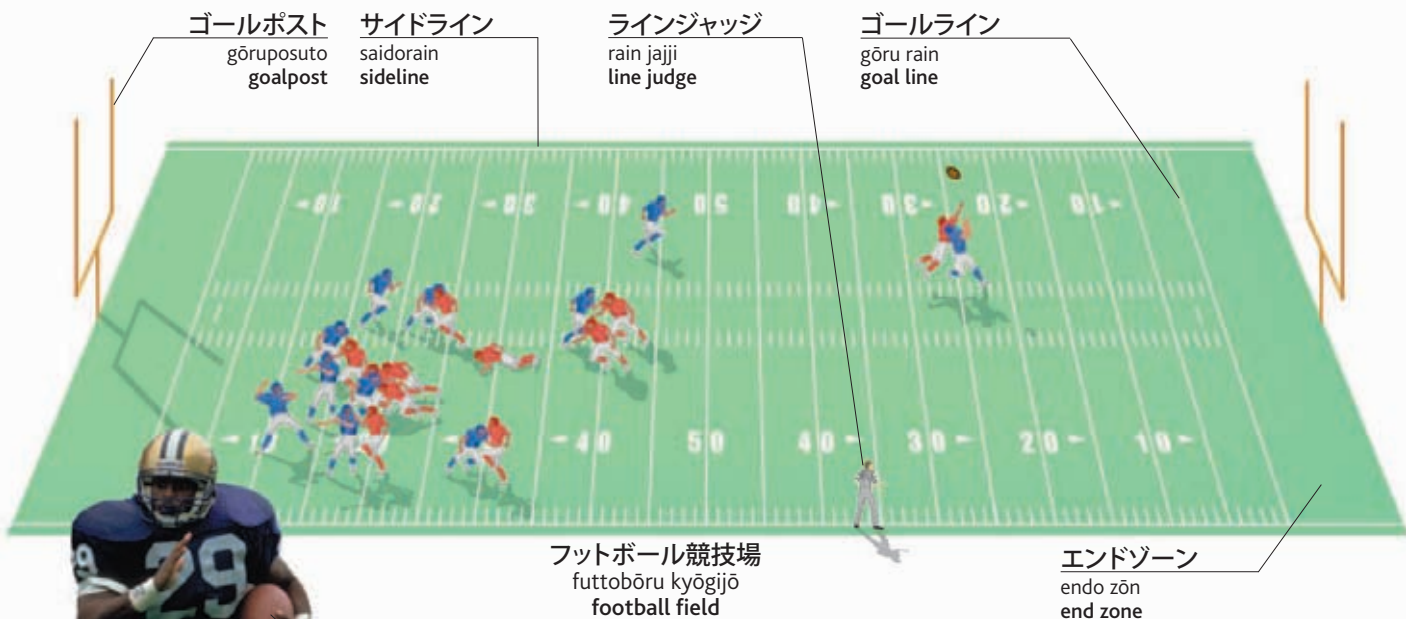

(フットボール用) ボール  
(futtobōru-yō) bōru  
football

パッド  
paddo  
pads

ヘルメット  
herumetto  
helmet

フットボール選手  
futtobōru senshu  
football player



### 関連用語 kanrenyōgo • vocabulary

タイムアウト  
taimu auto  
time out

チーム  
chīmu  
team

防御  
bōgyo  
defense

チアリーダー  
chiaridā  
cheerleader

得点は何点ですか。  
tokuten wa nanten desuka?  
What is the score?

ファンブル  
famburu  
fumble

攻撃  
kōgeki  
attack

得点  
tokuten  
score

タッチダウン  
tatchidaun  
touchdown

どちらが勝っていますか。  
dochira ga katte imasuka?  
Who is winning?



# ラグビー ragubī • rugby

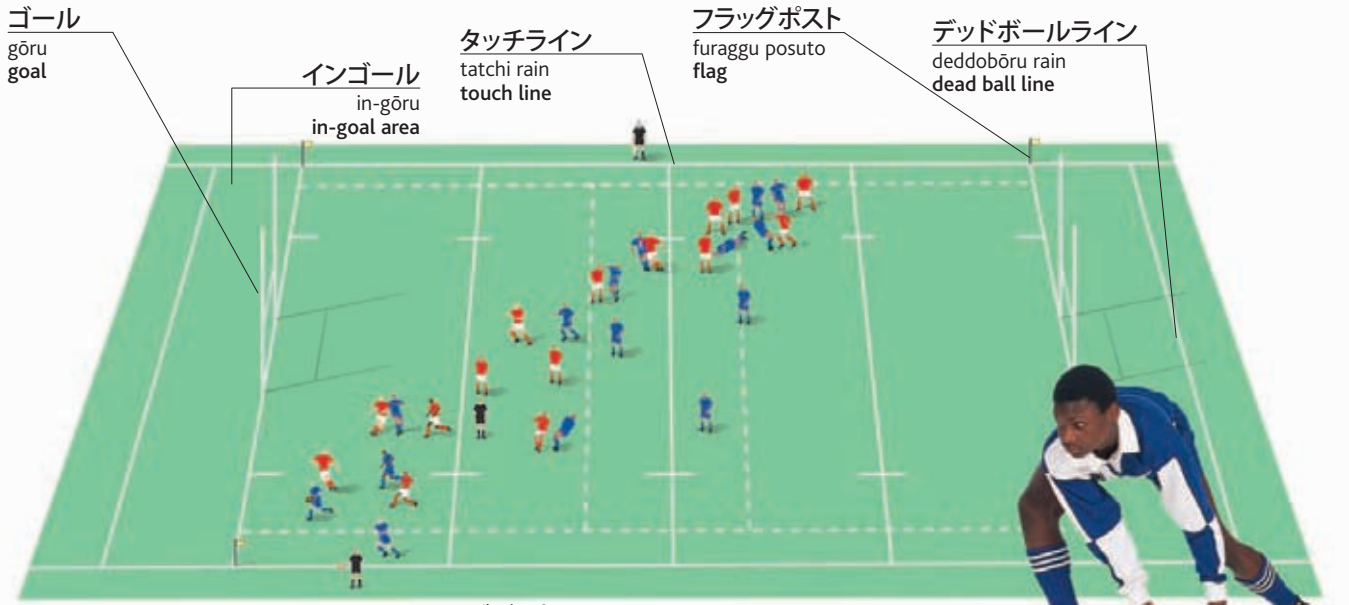

ラグビー場 ragubī-jō | rugby field

ラグビーボール  
ragubī bōru  
ball



蹴る  
keru  
kick (v)

ラグビー着  
ragubī-gi  
rugby uniform



パスする  
pasu suru  
pass (v)



タックルする  
takkuru suru  
tackle (v)

投げる  
nageru  
throw (v)



トライ  
torai  
try

ラグビー選手  
ragubi senshu  
player



ラック raku | ruck



スクラム sukuramu | scrum



# サッカー sakkā • soccer



サッカーボール  
sakkā bōru  
soccer ball

ゴールキーパー  
gōrukīpā  
goalkeeper

サッカー 着  
sakkā-gi  
soccer uniform

サッカー選手  
sakkā senshu  
soccer player

フォワード  
fowādo  
forward

審判  
shimpan  
referee

センターサークル  
sentā sākuru  
center circle



ゴールポスト  
gōruposuto  
goalpost

ネット  
netto  
net

クロスバー  
kurosubā  
crossbar



ゴール gōru | goal

サッカー場  
sakkā-jō  
soccer field



ドリブルする doriburu suru  
dribble (v)



ヘディングする  
hedingu suru  
head (v)



フリーキック furī kikku | free kick

壁  
kabe  
wall

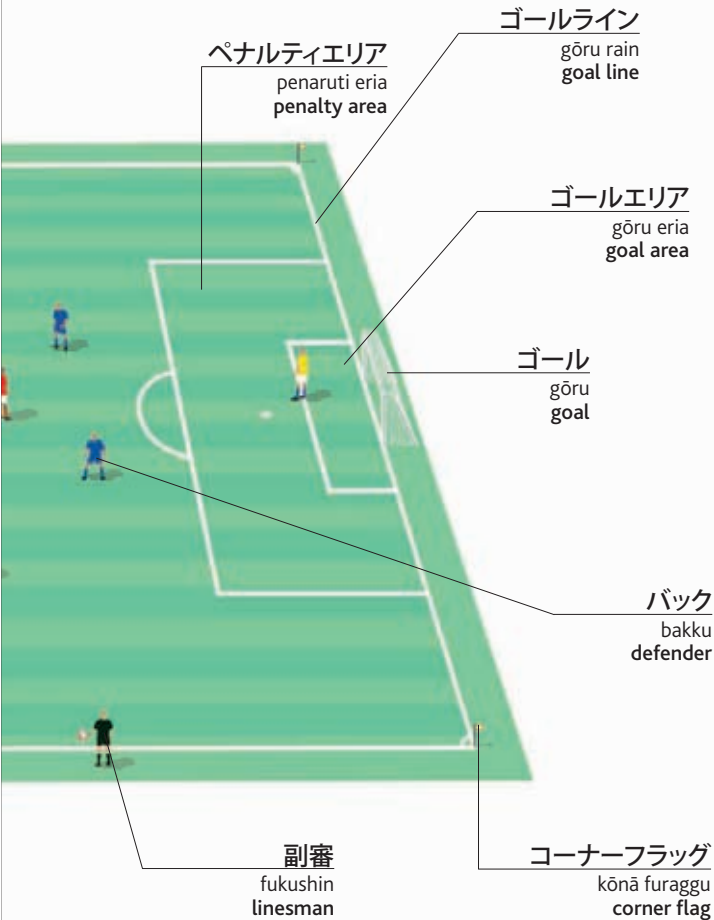

スローイン surō-in  
throw-in



蹴る keru | kick (v)



送球する  
sōkyū suru  
pass (v)

サッカーシューズ  
sakkā shūzu  
boot



シュートする  
shūto suru  
shoot (v)



セーブする  
sēbu suru  
save (v)

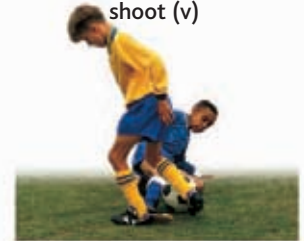

タックルする  
takkuru suru  
tackle (v)

関連用語 kanrenyōgo • vocabulary

競技場  
kyōgijō  
stadium

ファウル  
fauru  
foul

イエローカード  
ierō kādo  
yellow card

連盟  
renmei  
league

延長時間  
enchō jikan  
extra time

1点あげる  
ikken ageru  
score a goal (v)

コーナーキック  
kōnā kikku  
corner

オフサイド  
ofu-saido  
off-side

引分け  
hikiwake  
draw

補欠選手  
hoketsusenshu  
substitute

ペナルティー  
penaruti  
penalty

レッドカード  
reddo kādo  
red card

退場する  
taijō suru  
send off (v)

ハーフタイム  
hāfu taimu  
half time

代理  
dairi  
substitution

# ホッケー hokkē • hockey

## アイスホッケー aisu hokkē • ice hockey



## フィールドホッケー fīrudo hokkē • field hockey

ホッケー用スティック  
hokkē-yō sutikku  
hockey stick



パック  
paku  
puck

アイスホッケー選手 aisu hokkē senshu  
ice hockey player





# クリケット kuriketto • cricket

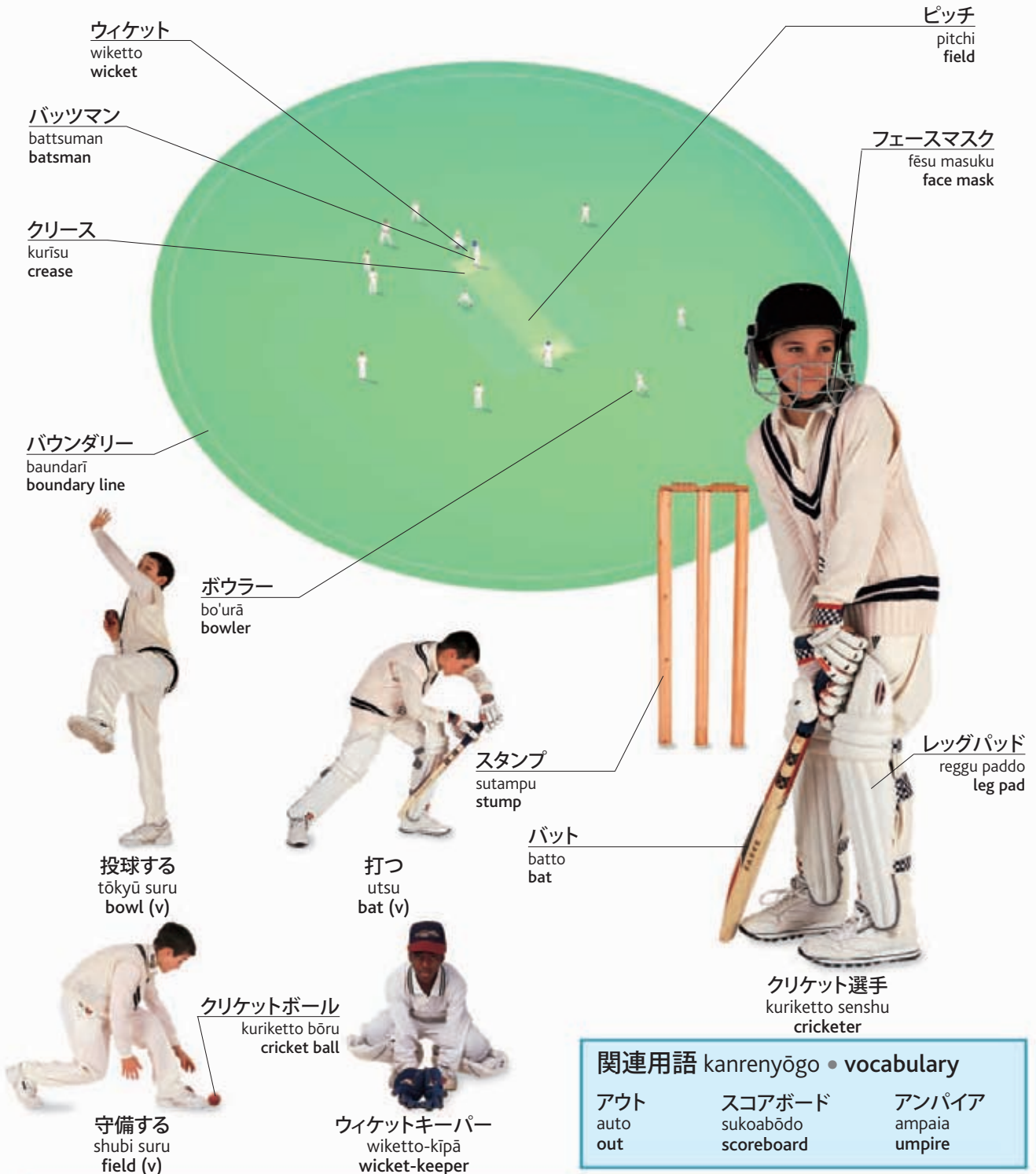

ウィケット  
wiketto  
wicket

バッツマン  
battsuman  
batsman

クリース  
kurīsu  
crease

バウンダリー  
baundarī  
boundary line

ボウラー  
bo'urā  
bowler

投球する  
tōkyū suru  
bowl (v)

打つ  
utsu  
bat (v)

クリケットボール  
kuriketto bōru  
cricket ball

守備する  
shubi suru  
field (v)

ウィケットキーパー  
wiketto-kīpā  
wicket-keeper

スタンプ  
sutampu  
stump

バット  
batto  
bat

クリケット選手  
kuriketto senshu  
cricketer

ピッチ  
pitchi  
field

フェースマスク  
fēsu masuku  
face mask

レッグパッド  
reggu paddo  
leg pad

## 関連用語 kanrenyōgo • vocabulary

アウト  
auto  
out

スコアボード  
sukoabōdo  
scoreboard

アンパイア  
ampaia  
umpire

# バスケットボール basukettobōru • basketball

サイドライン  
saidorain  
sideline

審判  
shimpan  
referee

センターサークル  
sentā sākuru  
center circle

フリースローライン  
furīsurō rain  
free-throw line

エンドライン  
endorain  
endline



ボール  
bōru  
ball

ゼッケン  
zekken  
number

バックボード  
bakkubōdo  
backboard

ゴールリング  
gōru ringu  
hoop

ゴールネット  
gōru netto  
net

バスケット  
basuketto  
basket

コート kōto | court

センターライン  
sentārain  
centerline

スリーポイントライン  
surī-pointo rain  
three-point line

## 関連用語 kanrenyōgo • vocabulary

パス pasu pass  
スローイン surō-in throw-in

ファウル fauru foul  
ジャンプボール jampu bōru jump ball

リバウンド ribaundo rebound  
アウトオブバウンズ auto obu baunzu out of bounds

バスケットボール選手  
basukettobōru senshu | basketball player

動作 dōsa • actions



投げる  
nageru  
throw (v)



受ける  
ukeru  
catch (v)



シュートする  
shūto suru  
shoot (v)



ジャンプする  
jampu suru  
jump (v)



ダンクシュートする  
dankushūto suru  
dunk (v)



マークする  
māku suru  
mark (v)



ブロックする  
burokku suru  
block (v)



バウンドする  
baundo suru  
bounce (v)

バレーボール barēbōru • volleyball

ブロックする  
burokku suru  
block (v)

ネット  
netto  
net

レシーブする  
reshību suru  
dig (v)



審判  
shimpan  
referee

サポーター  
sapōtā  
knee support

コート kōto | court



# 野球 yakyū • baseball

## 球場 kyūjō • field

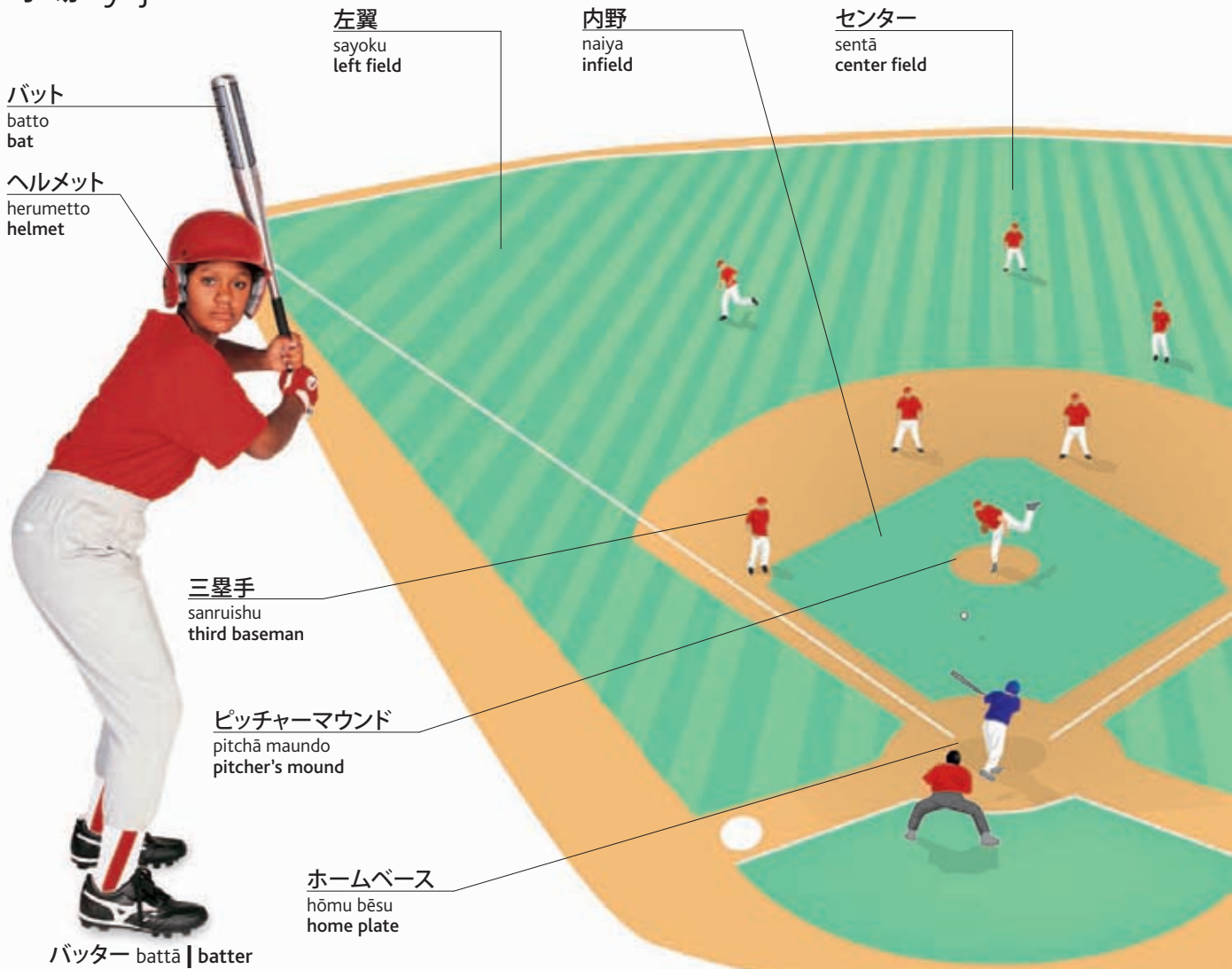

### 関連用語 kanrenyōgo • vocabulary

|                          |                     |                                    |
|--------------------------|---------------------|------------------------------------|
| イニング<br>iningu<br>inning | セーフ<br>sēfu<br>safe | ファウルボール<br>fauru bōru<br>foul ball |
| ラン<br>ran<br>run         | アウト<br>auto<br>out  | ストライク<br>sutoraiku<br>strike       |



ミット mitto  
mitt

ボール  
bōru  
ball



マスク masuku  
mask

動作 dōsa • actions

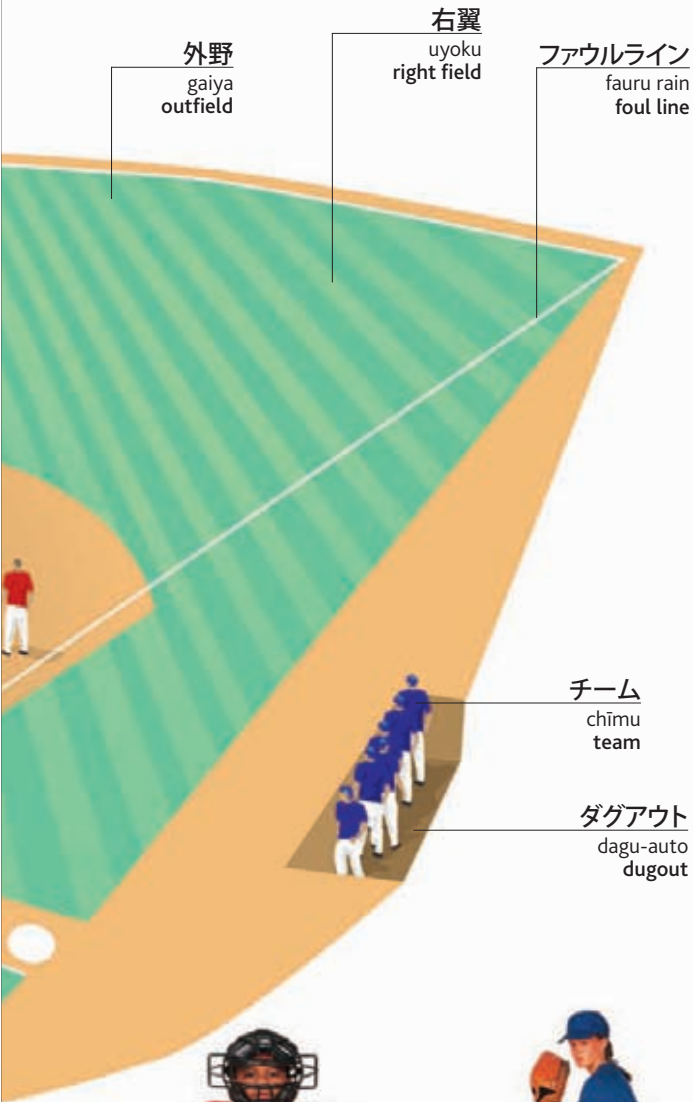

キャッチャー kyatchā  
catcher



ピッチャー pitchā  
pitcher



投げる nageru | throw (v)



捕球する hokyū suru | catch (v)



走る hashiru  
run (v)



フィールディングする  
firudingu suru | field (v)

スライディングする  
suraidingu suru  
slide (v)



タッチアウトする  
tatchiauto suru  
tag (v)

投球する  
tōkyū suru  
pitch (v)



打つ  
utsu  
bat (v)

審判  
shimpan  
umpire

野球をする yakyū o suru | play (v)

# テニス tennis • tennis

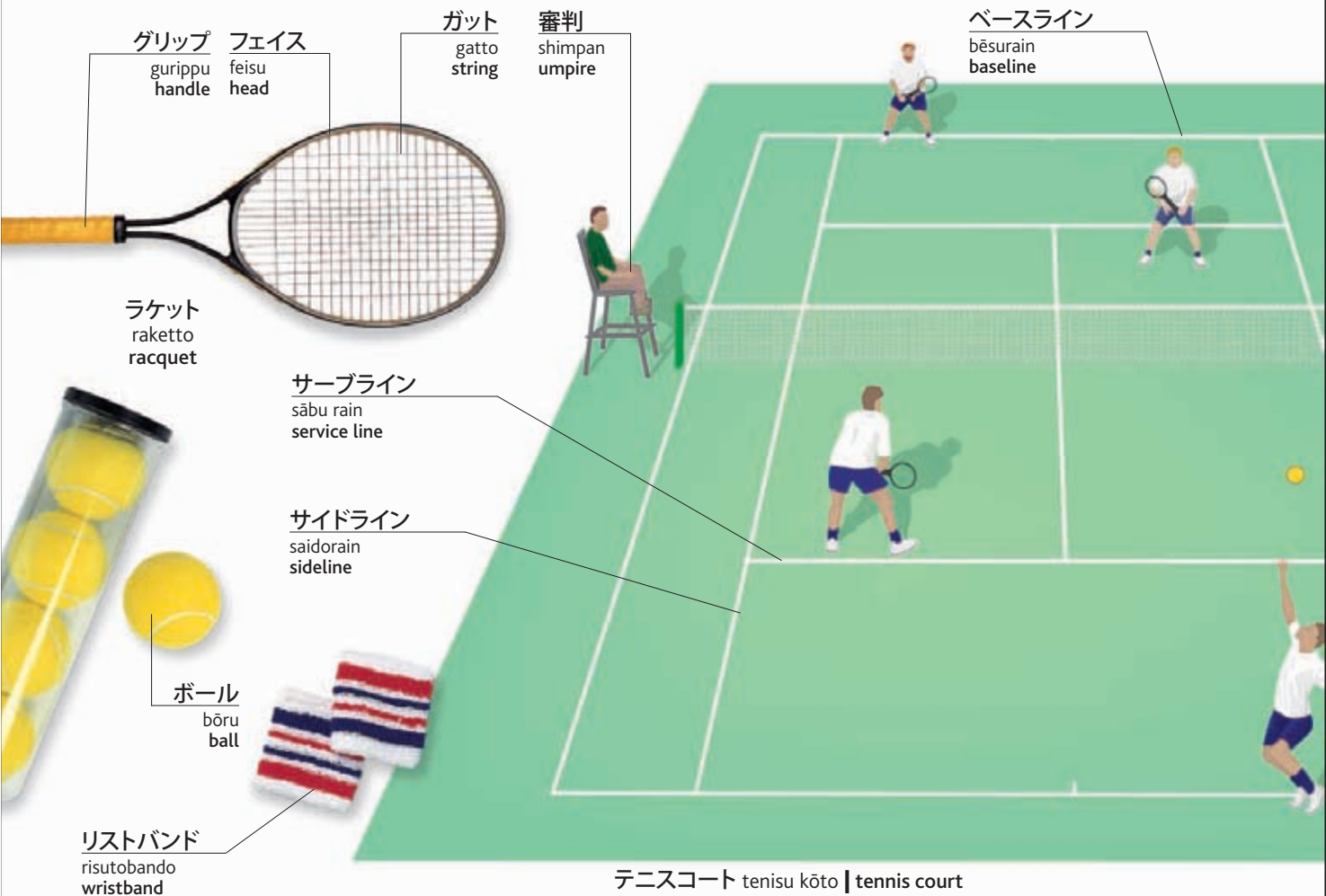

## 関連用語 kanrenyōgo • vocabulary

シングルス  
shingurusu  
singles

セット  
setto  
set

ラブ  
rabu  
love

フォルト  
foruto  
fault

スライス  
suraisu  
slice

線審  
senshin  
linesman

ダブルス  
daburusu  
doubles

マッチ  
matchi  
match

デュース  
dyūsu  
deuce

エース  
ēsu  
ace

ラリー  
rarī  
rally

選手権  
senshuku  
championship

ゲーム  
gēmu  
game

タイブレーク  
taiburēku  
tiebreak

アドバンテージ  
adobantēji  
advantage

ドロブショット  
doroppu shotto  
dropshot

レット  
retto!  
let!

スピン  
supin  
spin





テニス選手 tenisu senshu | player

ストローク sutorōku • strokes



サーブ sābu serve

ボレー borē volley



リターン ritān return



ロボ robu lob



フォアハンド foahando forehand



バックハンド bakkuhando backhand

ラケットスポーツ raketto supōtsu • racquet games



シャトル shatoru shuttlecock

バドミントン badominton badminton



ラケット raketto bat

卓球 takkyū table tennis



スカッシュ sukasshu squash



ラケットボール raketto bōru racquetball

# ゴルフ gorufu • golf



用具 yōgu • equipment



ゴルフクラブ  
gorufu kurabu  
• golf clubs



動作 dōsa • actions



関連用語 kanrenyōgo • vocabulary

|                                       |                              |                                     |                            |                                     |                                      |
|---------------------------------------|------------------------------|-------------------------------------|----------------------------|-------------------------------------|--------------------------------------|
| ホールインワン<br>hōru in wan<br>hole in one | パー<br>pā<br>par              | ハンディキャップ<br>handikyappu<br>handicap | キャディ<br>kyadi<br>caddy     | バックスイング<br>bakkusuingu<br>backswing | ストローク<br>sutorōku<br>stroke          |
| アンダーパー<br>andā pā<br>under par        | オーバーパー<br>ōbā pā<br>over par | トーナメント<br>tōnamento<br>tournament   | 観衆<br>kanshū<br>spectators | 素振り<br>suburi<br>practice swing     | プレーの線<br>purē no sen<br>line of play |



# 陸上競技 rikujō kyōgi • track and field

レーン  
rēn  
lane

トラック  
torakku  
track

ゴール  
gōru  
finishing line

スタートライン  
sutāto rain  
starting line

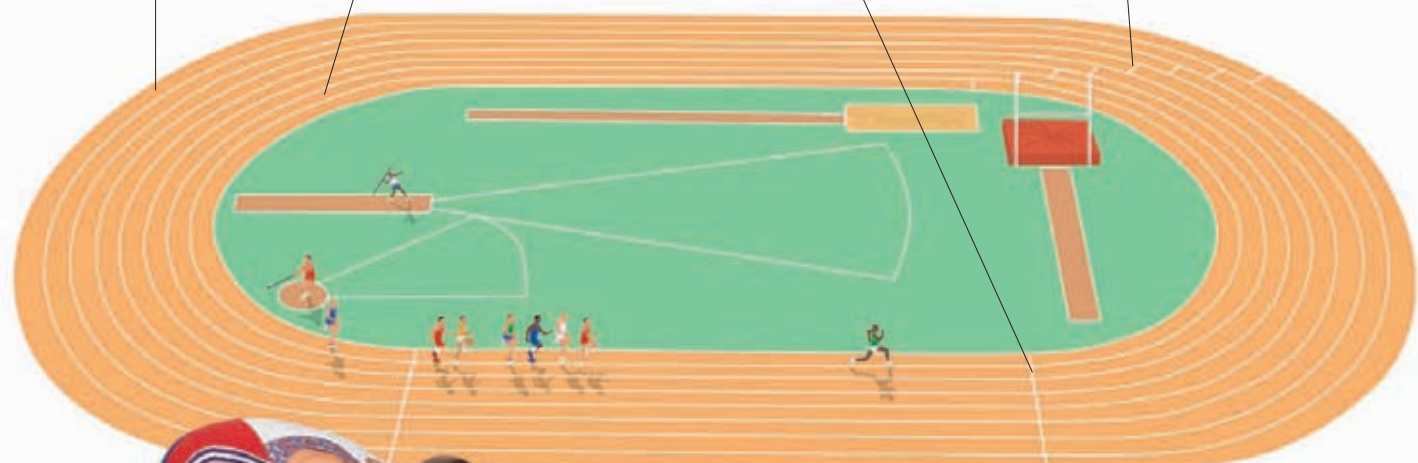

グラウンド  
gurando  
field

陸上競技者  
rikujō kyōgi-sha  
athlete



短距離走者  
tankyori sōsha  
sprinter

スターティングブロック  
sutātingu burokku  
starting blocks

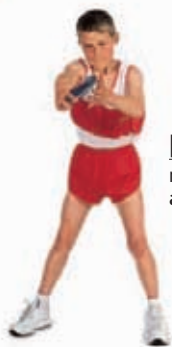

円盤投げ  
emban-nage  
discus



砲丸投げ  
hōgannage  
shotput



槍投げ  
yarinage  
javelin

## 関連用語 kanrenyōgo • vocabulary

競争  
kyōsō  
race

記録  
kiroku  
record

写真判定  
shashin hantei  
photo finish

棒高跳び  
bōtakatobi  
pole vault

時間  
jikan  
time

記録を破る  
kiroku o yaburu  
break a record (v)

マラソン  
marason  
marathon

自己最高記録  
jiko saikō kiroku  
personal best



ストップウォッチ  
sutoppuwotchi  
stopwatch

バトン  
baton  
baton



リレー競争  
rirē kyōsō  
relay race

バー  
bā  
crossbar



走り高跳び  
hashiritakatobi  
high jump



走り幅跳び  
hashirihabatobi  
long jump



ハードル走  
hādorūsō  
hurdles

## 体操競技 taisō kyōgi • gymnastics

跳躍板  
chōyaku-ban  
springboard



宙返り  
chūgaeri  
somersault



マット  
matto  
mat

床運動  
yuka undō  
floor exercises

体操選手  
taisō senshu  
gymnast



平均台 heikindai | beam

リボン  
ribon  
ribbon



側転  
sokuten  
tumble

新体操  
shintai shō  
rhythmic gymnastics

跳馬  
chōba  
horse



跳馬 (項目)  
chōba (kōmoku)  
vault

## 関連用語 kanrenyōgo • vocabulary

鉄棒  
tetsubō  
horizontal bar

鞍馬  
amba  
pommel horse

吊り輪  
tsuriwa  
rings

メダル  
medaru  
medals

銀  
gin  
silver

平行棒  
heikōbō  
parallel bars

段違い平行棒  
danchigai heikōbō  
asymmetric bars

表彰台  
hyōshō dai  
podium

金  
kin  
gold

銅  
dō  
bronze

# 格闘技 kakutōgi • combat sports

相手  
aite  
opponent

ヘッドガード  
heddogādo  
guard

ミット  
mitto  
glove

帯  
obi  
belt

テコンドー tekondō | tae-kwon-do

面  
men  
mask

竹刀  
shinai  
sword

合気道 aikidō | aikido

剣道 kendō | kendo

カンフー kanfū  
kung fu



キックボクシング  
kikkubokushingu | kickboxing

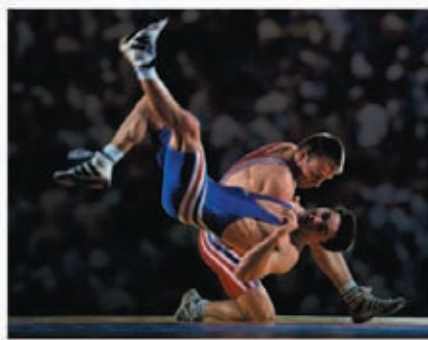

レスリング resuringu | wrestling



ボクシング bokushingu | boxing



空手 karate | karate



柔道 jūdō | judo





技 waza • actions



袈裟固 kesagatame | fall



襟掴み erizukami | hold



投げ nage | throw



抑え osae | pin



蹴り keri | kick



突き tsuki | punch



払い harai | strike



手刀打ち shutō uchi | chop



飛び蹴り tobi-geri | jump



受け uke | block

関連用語 kanrenyōgo • vocabulary

リング  
ringu  
boxing ring

ラウンド  
raundo  
round

拳  
kobushi  
fist

黒帯  
kuro obi  
black belt

カポエイラ  
kapoeira  
capoeira

グローブ  
gurōbu  
boxing gloves

試合  
shiai  
bout

ノックアウト  
nokku auto  
knock out

護身  
goshin  
self defense

相撲  
sumō  
sumo wrestling

マウスピース  
mausu pīsu  
mouth guard

練習試合  
renshū-jiai  
sparring

パンチバッグ  
panchi baggu  
punch bag

武道  
budō  
martial arts

太極拳  
taijyokuken  
tai-chi

# 水泳 suiei • swimming

## 水泳用品 suiei yōhin • equipment



アームバンド  
āmubando  
armband



ゴーグル gōguru | goggles

鼻栓  
hana sen  
nose clip



スイムボード  
suimubōdo | float



水着 mizugi | swimsuit

レーン  
rēn  
lane

水  
mizu  
water

スタート台  
sutāto dai  
starting block



プール pūru | swimming pool

水泳帽  
suei-bō  
cap

海水パンツ  
kaisui pantsu  
trunks

水泳選手 suiei senshu | swimmer

飛び板  
tobi-ita  
springboard

飛び込み選手  
tobikomi senshu  
diver



飛び込む tobikomu | dive (v)



泳ぐ oyogu | swim (v)



回転 kaiten | turn

泳法 eihō • styles



クロール kurōru | front crawl



平泳ぎ hiraoyogi | breaststroke



背泳ぎ seoyogi | backstroke

かき  
kaki  
stroke



バタフライ batafurai | butterfly

蹴り  
keri  
kick

スキューバダイビング sukyūba daibingu • scuba diving

ウェットスーツ  
wettosūtsu  
wetsuit

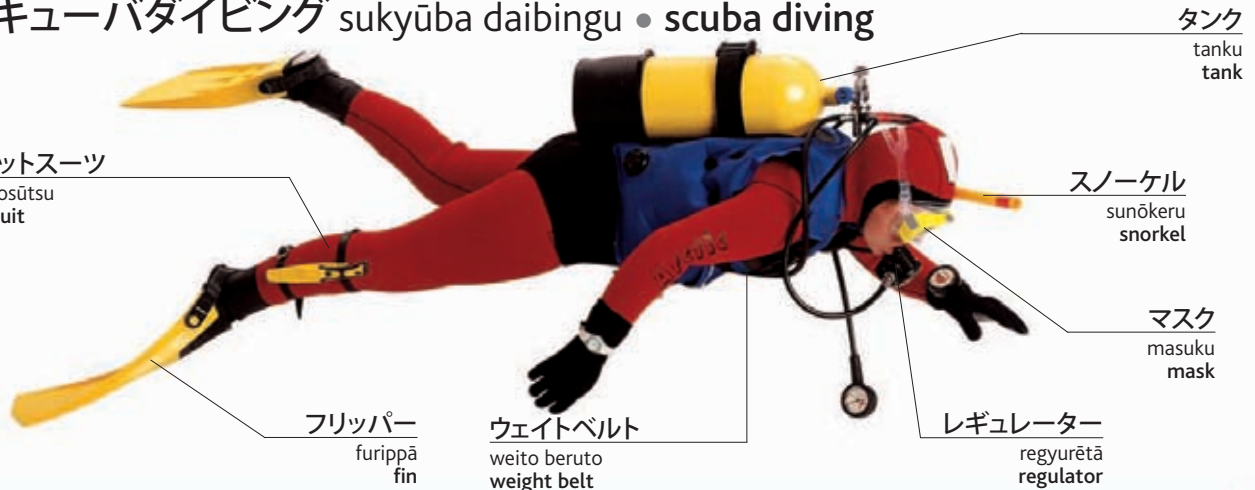

タンク  
tanku  
tank

スノーケル  
sunōkeru  
snorkel

マスク  
masuku  
mask

レギュレーター  
regyurētā  
regulator

ウェイトベルト  
weito beruto  
weight belt

フリッパー  
furippā  
fin

関連用語 kanrenyōgo • vocabulary

飛び込み  
tobikomi  
dive

立ち泳ぎする  
tachioyogi suru  
tread water (v)

ロッカー  
rokkā  
lockers

水球  
suikyū  
water polo

浅瀬  
asase  
shallow end

こむら返り  
komuragaeri  
cramp

高飛び込み  
takatobikomi  
high dive

飛び込みスタート  
tobikomi sutāto  
racing dive

救助員  
kyūjo-in  
lifeguard

深み  
fukami  
deep end

シンクロナイズドスイミング  
shinkuronaizudo suimingu  
synchronized swimming

溺れる  
oboreru  
drown (v)



# セーリング sēringu • sailing



コンパス  
kompasu  
compass



錨  
ikari  
anchor

ヘッドセール  
heddosēru  
headsail

クリート  
kurīto  
cleat

サイドデッキ  
saido dekki  
side deck

船首  
senshu  
bow

舵棒  
kaji bō  
tiller

船体  
sentai  
hull

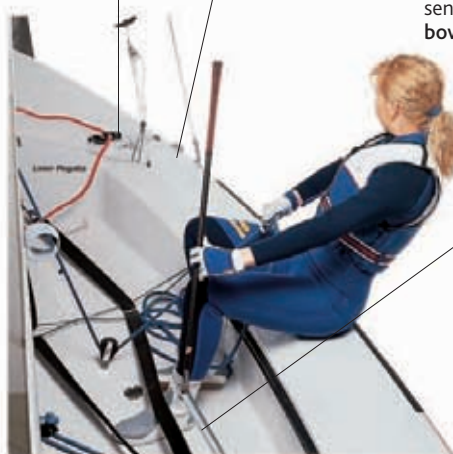

航行する kōkō suru | navigate (v)

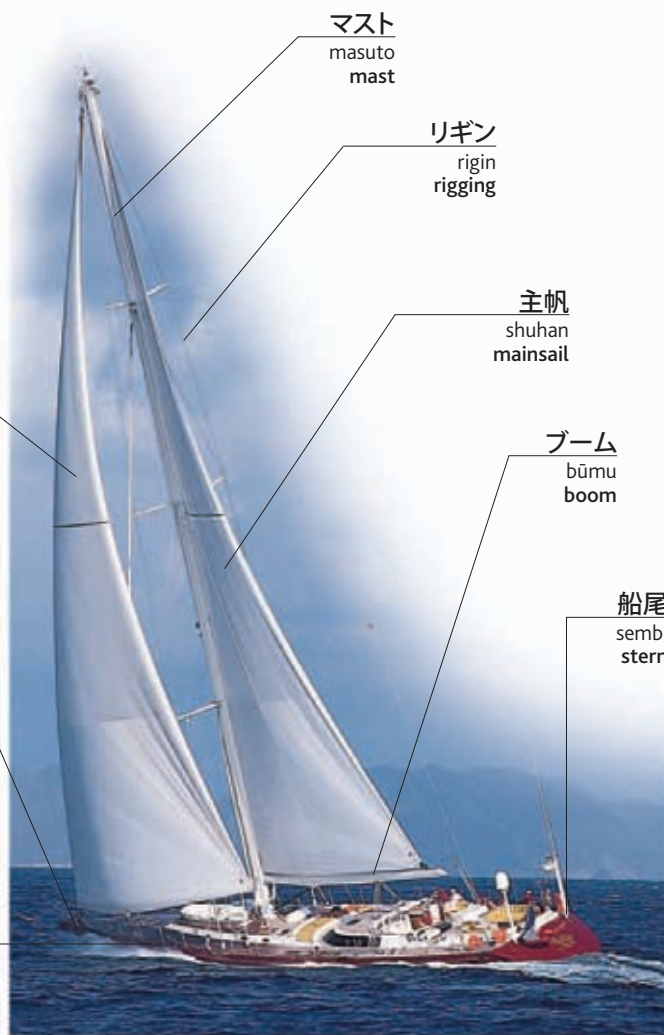

マスト  
masuto  
mast

リギン  
rigin  
rigging

主帆  
shuhan  
mainsail

ブーム  
būmu  
boom

船尾  
sembi  
stern

ヨット yotto | yacht

# 安全用具 anzen yōgu • safety



照明弾  
shōmeidan  
flare



救命ブイ  
kyūmei bui  
lifebuoy



救命胴衣  
kyūmei dōi  
life jacket



救命ボート  
kyūmei bōto  
life raft

# 水上スポーツ suijō supōtsu • watersports

漕ぎ手  
kogite  
rower



オール  
ōru  
oar

カヤック  
kayakku  
kayak



パドル  
padoru  
paddle

漕ぐ kogu | row (v)

カヌー  
kanū  
canoeing

セール  
sēru  
sail



ウインドサーファー  
uindosāfā  
windsurfer

ボード  
bōdo  
board

ウインドサーフィン uindosāfin  
windsurfing

サーフボード  
sāfubōdo  
surfboard



サーフィン  
sāfin  
surfing

水上スキー板  
suijōsukī ita  
ski



水上スキー  
suijōsukī  
waterskiing



高速ボート  
kōsoku bōto  
speed boating

フットストラップ  
futtosutorappu  
footstrap



ラフティング  
rafutingu  
rafting



ジェットスキー  
jettosukī  
jet skiing

## 関連用語 kanrenyōgo • vocabulary

水上スキーヤー  
suijōsukīyā  
waterskier

乗組員  
norikumi'in  
crew

風  
kaze  
wind

寄せ波  
yosenami  
surf

シート  
shīto  
sheet

センターボード  
sentābōdo  
centerboard

サーファー  
sāfā  
surfer

タッキングする  
takkingu suru  
tack (v)

波  
nami  
wave

急流  
kyūryū  
rapids

舵  
kaji  
rudder

転覆する  
tempuku suru  
capsize (v)

# 乗馬 jōba • horseback riding

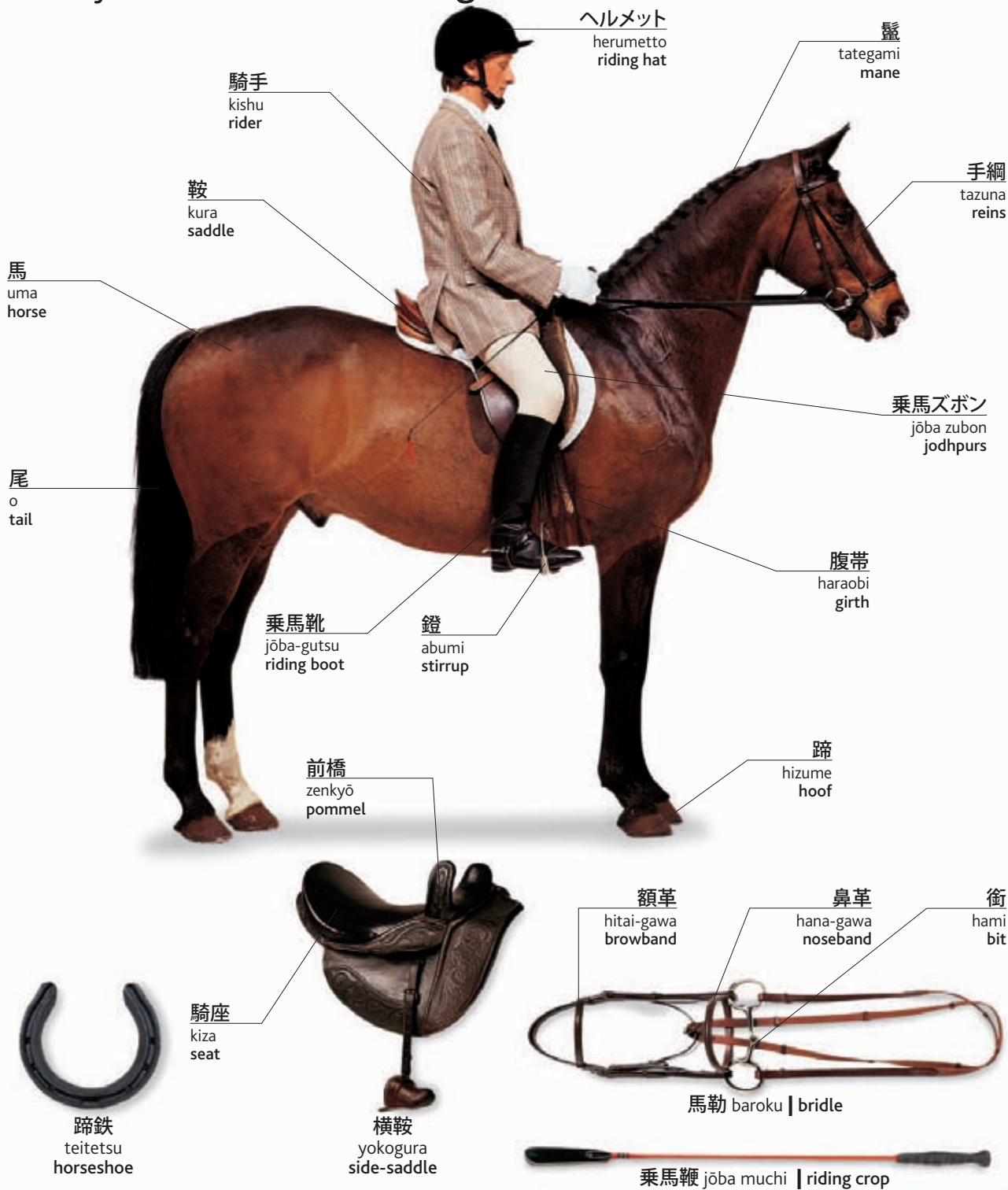



競技 kyōgi • events

競走馬  
kyōsōba  
racehorse



競馬  
keiba  
horse race

障害物  
shōgaibutsu  
fence

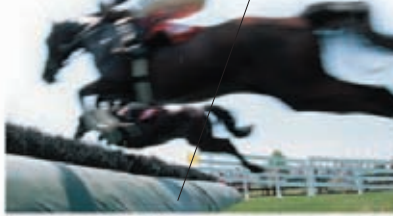

障害競走  
shōgai kyōsō  
steeplechase



繋駕競走  
keiga kyōsō  
harness race



ロデオ  
rodeo  
rodeo



障害飛越  
shōgai hietsu  
showjumping



馬車レース  
basha rēsu  
carriage race



トレッキング tōrekkingu | trekking



馬場馬術 baba bajutsu | dressage



ポロ poro | polo

関連用語 kanrenyōgo • vocabulary

常歩  
namiashi  
walk

駆歩  
kakeashi  
canter

ジャンプ  
jampu  
jump

端綱  
hazuna  
halter

パドック  
padokku  
paddock

平地競走  
heichi kyōsō  
flat race

速歩  
haya'ashi  
trot

襲歩  
shūho  
gallop

馬手  
umate  
groom

馬屋  
umaya  
stable

アリーナ  
arīna  
arena

競馬場  
keibajō  
racecourse

# 釣り tsuri • fishing



錘 omori | weight

返し  
kaeshi  
barb

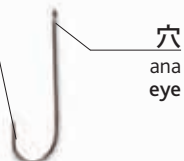

穴  
ana  
eye

釣り針  
tsuribari  
fishhook



餌 esa | bait



浮き  
uki  
float



ルアー  
ruā  
lure



フライ  
furai  
fly



手網  
tamo  
landing net



タックルボックス  
takkuru bokkusu  
tackle box



フラシ  
furashi  
keep net

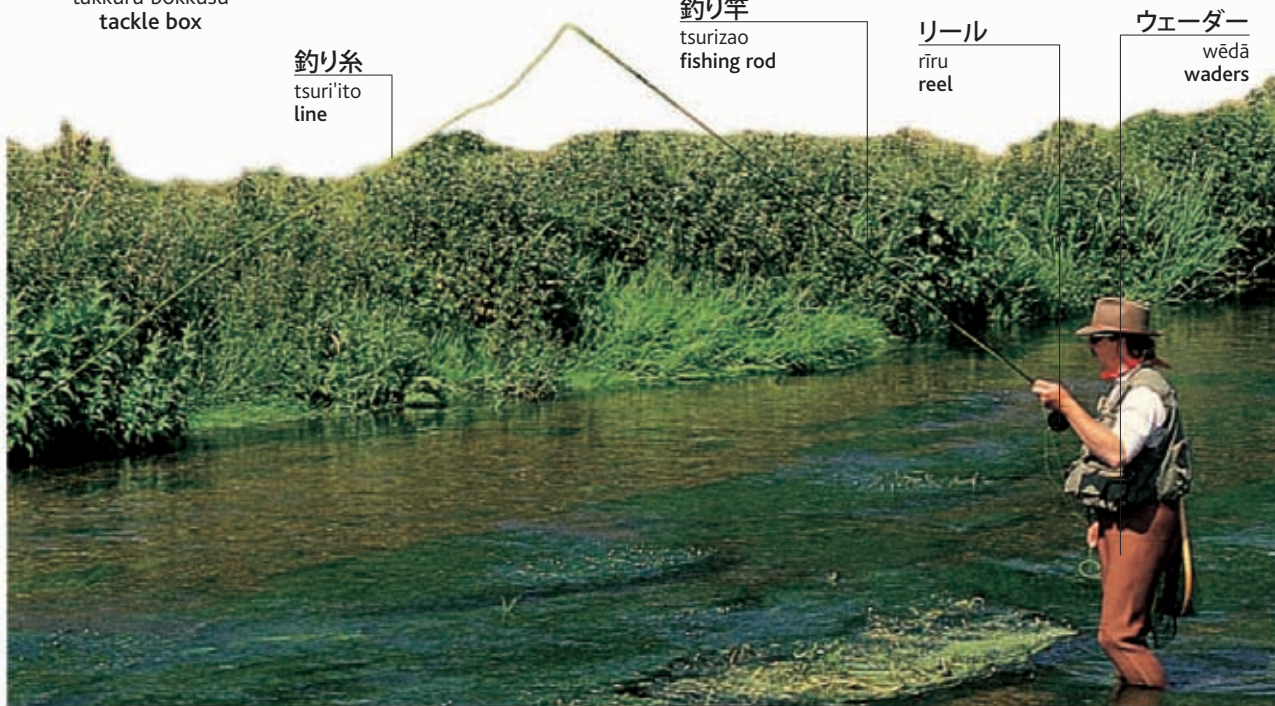

釣り糸  
tsuri'ito  
line

釣り竿  
tsurizao  
fishing rod

リール  
rīru  
reel

ウェーダー  
wēdā  
waders

釣り人 tsuribito | angler



## 釣りの種類 tsuru no shurui • types of fishing



淡水釣り  
tansui-zuri  
freshwater fishing



フライフィッシング  
furai fisshingu  
fly fishing

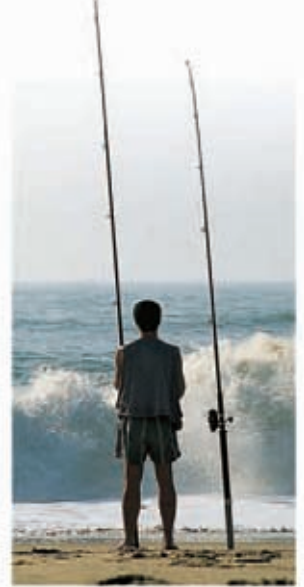

磯釣り  
isozuri  
surfcasting



スポーツフィッシング  
supōtsu fisshingu  
sport fishing



深海釣り  
shinkai-zuri  
deep sea fishing

## 動作 dōsa • activities



投げる  
nageru  
cast (v)



釣る  
tsuru  
catch (v)



引き寄せる  
hikiyoseru  
reel in (v)



網打ちする  
amiuchi suru  
net (v)



放す  
hanasu  
release (v)

## 関連用語 kanrenyōgo • vocabulary

誘き寄せる  
obikiyoseru  
bait (v)

タックル  
takkuru  
tackle

雨具  
amagu  
waterproofs

釣り許可証  
tsuri kyokashō  
fishing permit

魚籠  
biku  
creel

針にかかる  
hari ni kakaru  
bite (v)

スプール  
supūru  
spool

竿  
sao  
pole

海釣り  
umizuri  
marine fishing

ヤス漁  
yasu ryō  
spearfishing



# スキー sukī • skiing

スキー場  
sukī-jō  
ski slope

リフト  
rifuto  
chairlift

ケーブルカー  
kēburu kā  
cable car

スキーウェア  
sukīwea  
ski suit

ストック  
sutokku  
ski pole

グローブ  
gurōbu  
glove

ゲレンデ  
gerende  
ski run

スキー靴  
sukī-gutsu  
ski boot

安全柵  
anzen saku  
safety barrier

スキー板  
sukī ita  
ski

エッジ  
ejji  
edge

スキーヤー  
sukiyā  
skier

トップ  
toppu  
tip



競技 kyōgi • events



滑降  
kakkō  
downhill skiing



旗門  
kimon  
gate  
回転  
kaiten  
slalom



ジャンプ  
jampu  
ski jump



クロスカントリー  
kurosu-kantōri  
cross-country skiing

ウィンタースポーツ wintā supōtsu • winter sports



アイスクライミング  
aisu kuraimingu  
ice climbing



アイススケート  
aisu sukēto  
ice skating



フィギュアスケート  
figyuasukēto  
figure skating

ゴーグル  
gōguru  
goggles



スノーボード  
sunōbōdo  
snowboarding

スケート靴  
sukēto-gutsu  
skate



ボブスレー  
bobusurē  
bobsled



リュージュ  
ryūju  
luge



スノーモービル  
sunōmōbiru  
snowmobile



そり滑り  
sori suberi  
sledding

関連用語 kanrenyōgo • vocabulary

アルペンスキー  
arupen sukī  
alpine skiing

犬ぞり滑り  
inu-zori suberi  
dog sledding

大回転  
daikaiten  
giant slalom

スピードスケート  
supīdo sukēto  
speed skating

ゲレンデ外  
gerende-gai  
off-piste

バイアスロン  
baiasuron  
biathlon

カーリング  
kāringu  
curling

雪崩  
nadare  
avalanche



# 他のスポーツ ta no supōtsu • other sports

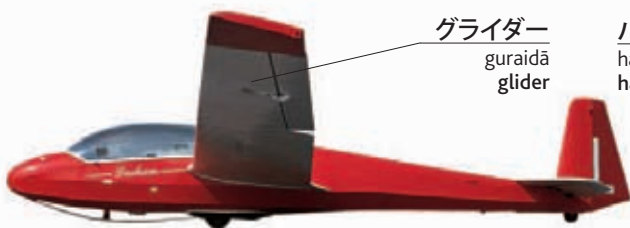

グライダー  
guraidā  
glider

ハンググライダー  
hangu guraidā  
hang-glider



ハンググライディング  
hangu guraidingu  
hang-gliding

グライディング  
guraidingu  
gliding

パラシュート  
parashūto  
parachute

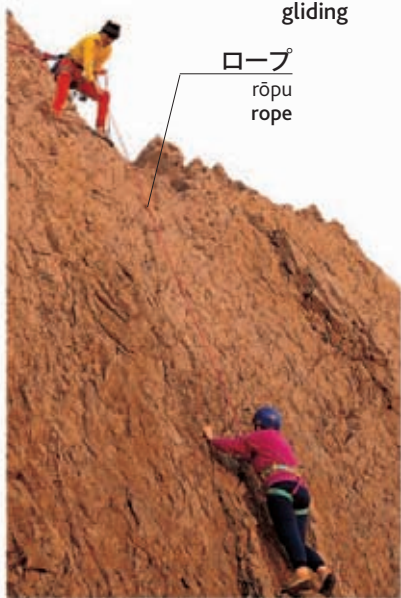

ロープ  
rōpu  
rope

ロッククライミング  
roku kuraimingu  
rock climbing



パラシュート降下  
parashūto kōka  
parachuting



パラグライディング  
paraguraidingu  
paragliding



スカイダイビング  
sukaidaibingu  
skydiving



アブザイレン  
abuzairen  
rappelling



バンジージャンプ  
banji jampu  
bungee jumping





ラリー  
rari  
rally driving



レーサー  
rēsā  
racing driver

自動車レース  
jidōsha rēsu  
auto racing



モトクロス  
motokurosu  
motorcross



オートバイレース  
ōtobai rēsu  
motorcycle racing



スケートボード  
sukētobōdo  
skateboard

ローラースケート靴  
rōrāsukēto-gutsu  
rollerskate



スケートボード乗り  
sukētobōdo-nori  
skateboarding

ローラースケート  
rōrāsukēto  
roller skating

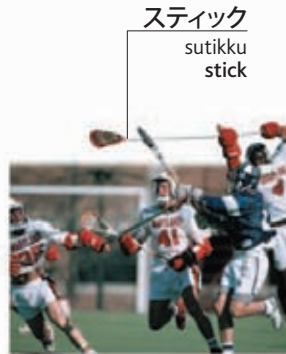

スティック  
sutikku  
stick

ラクロス  
rakurosu  
lacrosse

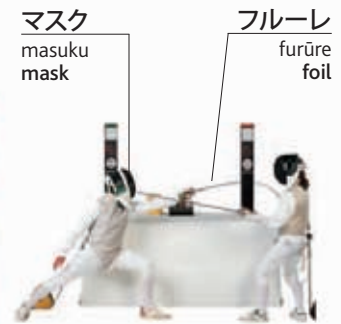

マスク  
masuku  
mask

フルーレ  
furūre  
foil

フェンシング  
fenshingu  
fencing

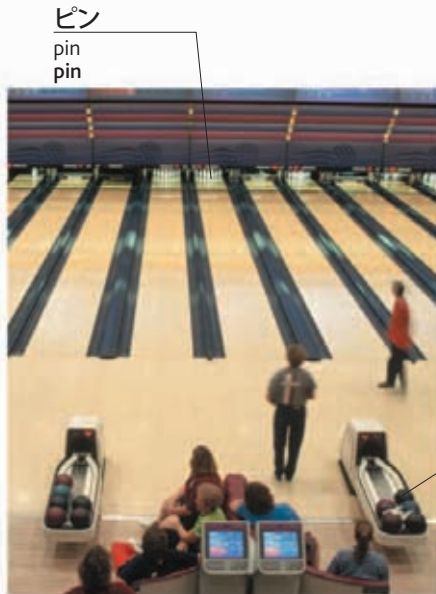

ピン  
pin  
pin

矢  
ya  
arrow

矢筒  
yazutsu  
quiver

ボウリング  
bo'uringu  
bowling

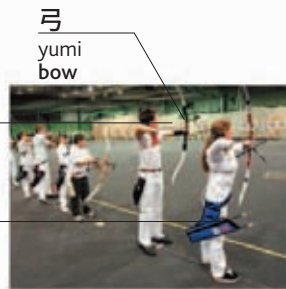

弓  
yumi  
bow

洋弓  
yōkyū  
archery



的  
mato  
target

ターゲット射撃  
tāgetto shageki  
target shooting



ボール  
bōru  
bowling ball

プール  
pūru  
pool



スヌーカー  
sunūkā  
snooker

# フィットネス fittonesu • fitness

エアロバイク  
earobaiku  
exercise bike

フリーウェイト  
furī weito  
free weights

バー  
bā  
bar

フィットネス器具  
fittonesu kigu  
gym machine

ベンチ  
benchi  
bench



ローイングマシーン  
rōingu mashīn  
rowing machine

スポーツジム  
supōtsu jimu  
gym



トレッドミル  
toreddomiru  
treadmill



クロストレーナー  
kurosu torēnā  
cross trainer



パーソナルトレーナー  
pāsonaru torēnā  
personal trainer



ステッパー  
suteppā  
step machine

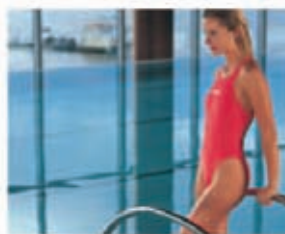

プール  
pūru  
swimming pool



サウナ  
sauna  
sauna



運動 undō • exercises



ストレッチ  
sutoretchi  
stretch



ランジ  
ranji  
lunge

タイツ  
taitsu  
tights

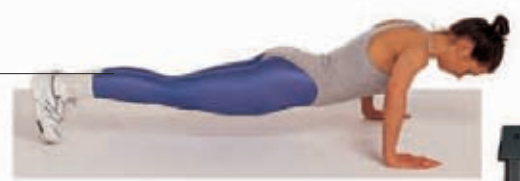

腕立て伏せ  
udetatefuse  
push-up



スクワット  
sukuwatto  
squat



腹筋運動  
fukkin undō  
sit-up



アームカール  
āmu kāru  
bicep curl

ダンベル  
danberu  
dumb bell



レッグプレス  
reggu puresu  
leg press



チェストプレス  
chesuto puresu  
chest press



スニーカー  
sunikā  
trainers

バーベル  
bāberu  
weight bar

ウェイトトレーニング  
weito torēningu  
weight training



ランニングシャツ  
ranningu shatsu  
vest

ジョギング  
jogingu  
jogging



エアロビクス  
earobikusu  
aerobics

関連用語 kanrenyōgo • vocabulary

トレーニングする  
torēningu suru  
train (v)

その場でジョギングする  
sono ba de jogingu suru  
run in place (v)

伸ばす  
nobasu  
extend (v)

ピラティス  
piratisu  
Pilates

サーキットトレーニング  
sākitto torēningu  
circuit training

準備運動をする  
jumbi undō o suru  
warm up (v)

動かす  
ugokasu  
flex (v)

懸垂する  
kensui suru  
pull up (v)

ボクササイズ  
bokusasaizu  
boxercise

縄跳び  
nawatobi  
skipping





娛樂 goraku  
leisure



# 劇場 gekijō • theater



幕  
maku  
curtain

袖  
sode  
wings

セット  
setto  
set

観客  
kankyaku  
audience

オーケストラ  
ōkesutora  
orchestra

舞台 butai | stage

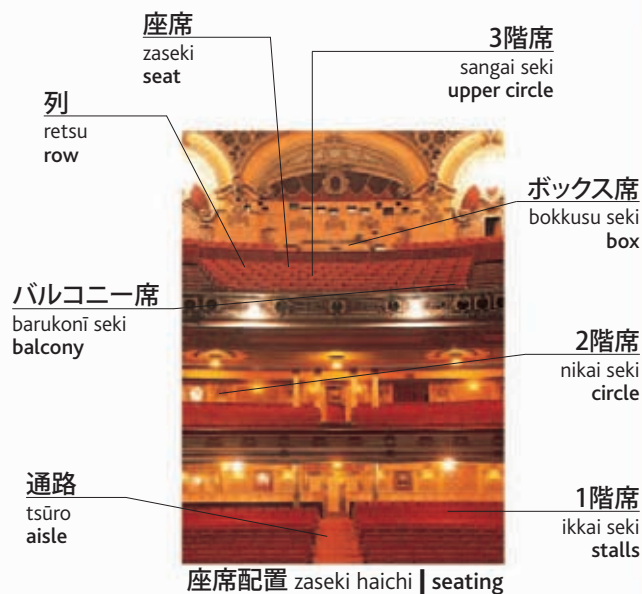

座席配置 zaseki haichi | seating

## 関連用語 kanrenyōgo • vocabulary

配役  
haiyaku  
cast

台本  
daihon  
script

初日  
shonichi  
first night

俳優  
haiyū  
actor

背景  
haikai  
backdrop

休憩時間  
kyūkei jikan  
interval

女優  
joyū  
actress

監督  
kantoku  
director

プログラム  
puroguramu  
program

劇  
geki  
play

プロデューサー  
purodyūsā  
producer

オーケストラピット  
ōkesutora pitto  
orchestra pit





音楽会 ongakukai | concert



ミュージカル myūjīkaru | musical

衣装  
ishō  
costume



バレエ barē | ballet

関連用語 kanrenyōgo • vocabulary

案内係  
annai-gakari  
usher

クラシック音楽  
kurashikku ongaku  
classical music

楽譜  
gakufu  
musical score

サウンドトラック  
saundotorakku  
soundtrack

拍手する  
hakushu suru  
applaud (v)

アンコール  
ankōru  
encore

今晚のチケットを2枚ください。  
konban no chiketto o ni-mai kudasai.  
I'd like two tickets for tonight's  
performance.

何時に始まりますか。  
nanji ni hajimarimasuka?  
What time does it start?



オペラ opera | opera

映画 eiga • cinema

ポップコーン  
poppukōn  
popcorn



チケット売場  
chiketto uriba  
box office

ロビー  
robī  
lobby

ポスター  
posutā  
poster



映画館  
eigakan  
cinema hall



映写幕  
eishamaku  
screen

関連用語 kanrenyōgo • vocabulary

コメディ  
komedi  
comedy

スリラー  
surirā  
thriller

ホラー映画  
horā eiga  
horror movie

西部劇  
seibugeki  
western

恋愛物語  
ren'ai monogatari  
romance

SF映画  
esu-efu eiga  
science fiction movie

冒険  
bōken  
adventure

アニメ映画  
anime eiga  
animated movie

# オーケストラ ōkesutora • orchestra

## 弦楽器 gengakki • strings



ピアノ piano | piano

楽譜  
gakufu  
score

へ音記号  
heon kigō  
bass clef

ト音記号  
to'on kigō  
treble clef

音符  
ompu  
note

五線譜  
gosenfu  
staff



記譜法 kifuhō | notation

### 関連用語 kanrenyōgo • vocabulary

序曲  
jokyoku  
overture

ソナタ  
sonata  
sonata

休止符  
kyūshifu  
rest

シャープ  
shāpu  
sharp

本位記号  
hon'i kigō  
natural

音階  
onkai  
scale

交響曲  
kōkyōkyoku  
symphony

楽器  
gakki  
instruments

ピッチ  
pitchi  
pitch

フラット  
furatto  
flat

小節  
shōsetsu  
bar

指揮棒  
shikibō  
baton

## 木管楽器 mokkan gakki • woodwind



ピッコロ  
pikkoro  
piccolo



フルート  
furūto  
flute



オーボエ  
ōboe  
oboe



イングリッシュホルン  
ingurisshu horun  
English horn



サクソフォン  
sakusofon  
saxophone



クラリネット  
kurarinetto  
clarinet



バスクラリネット  
basu kurarinetto  
bass clarinet



ファゴット  
fagotto  
bassoon



コントラファゴット  
kontora fagotto  
double bassoon

## 打楽器 dagakki • percussion



ケトルドラム  
ketorudoramu  
kettledrum



銅鑼  
dora  
gong



ボンゴ  
bongo  
bongos



スネアドラム  
sunea doramu  
snare drum



シンバル  
shimbaru  
cymbals



タンバリン  
tambarin  
tambourine



ビブラフォン  
biburafon  
vibraphone



トライアングル  
torainguru  
triangle



マラカス  
marakasu  
maracas

## 金管楽器 kinkan gakki • brass



トランペット  
torampetto  
trumpet



トロンボーン  
toronbōn  
trombone



フレンチホルン  
furenchi horun  
French horn



チューバ  
chūba  
tuba



# コンサート konsāto • concert



マイク  
maiku  
microphone

リードシンガー  
rīdo shingā  
lead singer

ドラマー  
doramā  
drummer

ギタリスト  
gitarisuto  
guitarist

ファン  
fan  
fans

ベーシスト  
bēshisuto  
bass guitarist

スピーカー  
supikā  
speaker

ロックコンサート rokku konsāto | rock concert

# 楽器 gakki • instruments

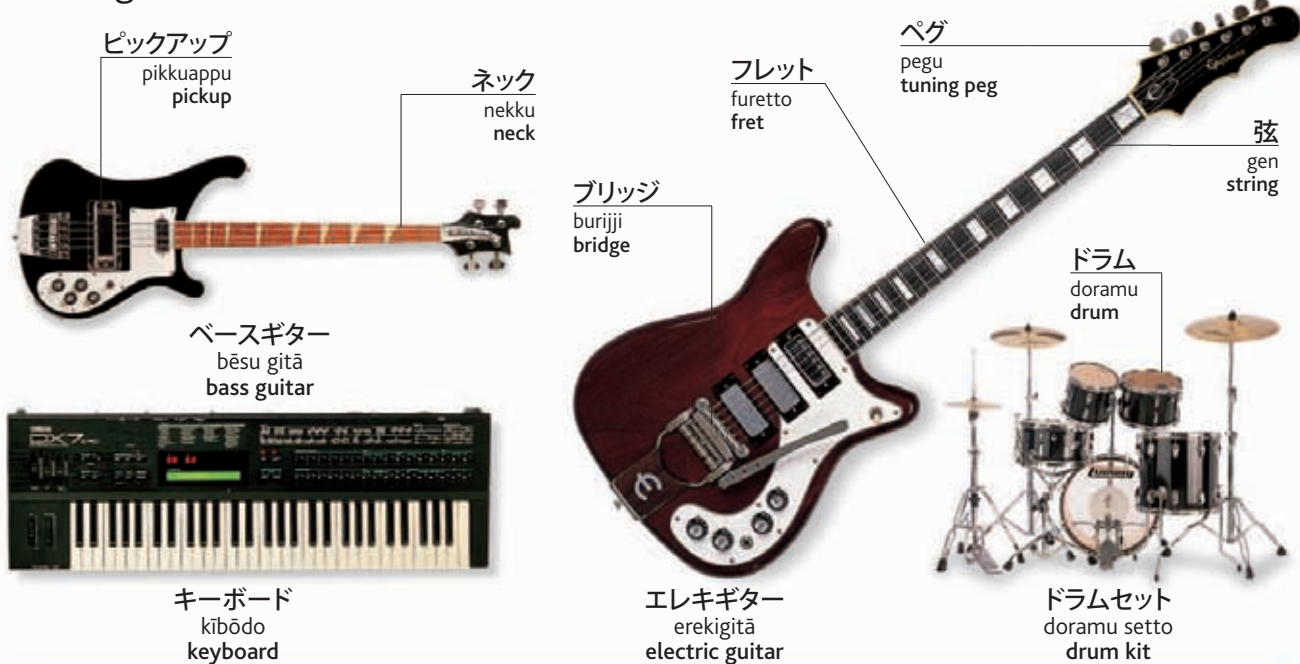

音楽ジャンル ongaku janru • music styles



ジャズ jazu | jazz



ブルース burūsu | blues



パンク panku | punk



フォーク fōku | folk music



ポップス poppusu | pop



ダンス dansu | dance



ラップ rappu | rap



ヘビーメタル hebī metaru  
heavy metal



クラシック kurasshikku  
classical music

関連用語 kanrenyōgo • vocabulary

歌  
uta  
song

歌詞  
kashi  
lyrics

メロディー  
merodī  
melody

ビート  
bīto  
beat

レゲエ  
rege'e  
reggae

カントリー  
kantōri  
country

スポットライト  
supottoraigo  
spotlight



# 観光 kankō • sightseeing



観光客  
kankō kyaku  
tourist

観光名所 kankō meisho | tourist attraction



観光ルート  
kankō rūto  
itinerary

オープントップ  
ōpun toppu  
open top

観光バス kankō basu | tour bus

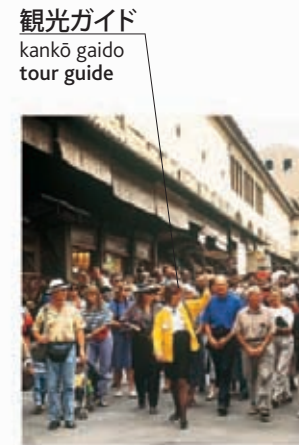

観光ガイド  
kankō gaido  
tour guide

ガイド付きツアー  
gaido-tsuki tsuā  
guided tour



小像  
shōzō  
statuette

土産物  
miyagemono  
souvenirs

## 関連用語 kanrenyōgo • vocabulary

開館  
kaikan  
open

観光案内書  
kankō annaisho  
guide book

カムコーダー  
kamukōdā  
camcorder

左  
hidari  
left

...は、どこですか。  
... wa doko desuka?  
Where is...?

閉館  
heikan  
closed

フィルム  
firumu  
movie

カメラ  
kamera  
camera

右  
migi  
right

道に迷ってしまいました。  
michi ni mayotte shimaimashita.  
I'm lost.

入場料  
nyūjō-ryō  
entrance fee

電池  
denchi  
batteries

行き方  
ikikata  
directions

まっすぐ  
massugu  
straight ahead

...への行き方を教えてください。  
... e no ikikata o oshiete kudasai.  
Can you tell me the way to...?



## 名所 meisho • attractions

絵画  
kaiga  
painting



美術館  
bijutsukan  
art gallery

展示品  
tenji-hin  
exhibit



記念碑  
kinenhi  
monument

展覧会  
tenrankai  
exhibition



博物館  
hakubutsukan  
museum

旧跡  
kyūseki  
famous ruin



歴史的建造物  
rekishi-teki kenzōbutsu  
historic building



カジノ  
kajino  
casino



庭園  
teien  
gardens



国立公園  
kokuritsu kōen  
national park

## 案内 annai • information

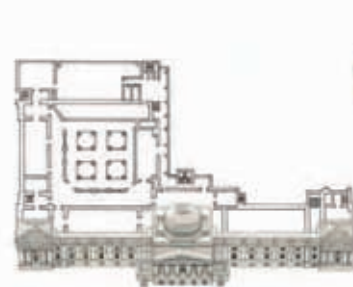

案内図  
annai zu  
floor plan



地図  
chizu  
map

時間  
jikan  
times



時刻表  
jikokuhyō  
timetable



観光案内所  
kankō annai-jo  
tourist information

# 野外活動 yagai katsudō • outdoor activities

歩道  
hodō  
footpath

日時計  
hidokei  
sundial

カフェ  
kafe  
café



公園 kōen | park

芝生  
shibafu  
grass

ベンチ  
benchi  
bench

平面幾何学式庭園  
heimen kikagaku-shiki teien  
formal gardens

ジェットコースター  
jetto kōsutā  
roller coaster



遊園地  
yūenchi  
fairground



テーマパーク  
tēma pāku  
theme park



サファリパーク  
safari pāku  
safari park



動物園  
dōbutsuen  
zoo



活動 katsudō • activities



サイクリング  
saikuringu  
bicycling



ジョギング  
jogingu  
jogging



スケートボード  
sukētobōdo  
skateboarding



ローラーブレード  
rōraburēdo  
rollerblading

乗馬道  
jōba-dō  
bridle path



野鳥観察  
yachō kansatsu  
bird watching



乗馬  
jōba  
horseback riding



ハイキング  
haikingu  
hiking

バスケット  
basuketto  
hamper



ピクニック  
pikunikku  
picnic

遊び場 asobiba • playground



砂場  
sunaba  
sandpit



水浴びプール  
mizuabi pūru  
paddling pool



ブランコ  
buranko  
swings



ジャングルジム janguru jimu  
climbing frame



シーソー shīsō | seesaw



滑り台 suberidai | slide



# 海辺 umibe • beach

ホテル  
hoteru  
hotel

ビーチパラソル  
bīchi parasoru  
beach umbrella

海の家  
umi no ie  
beach hut

砂  
suna  
sand

波  
nami  
wave

海  
umi  
sea



ビーチバッグ  
bīchi baggu  
beach bag

ビキニ  
bikini  
bikini



日光浴をする nikkōyoku o suru | sunbathe (v)



監視塔  
kanshitō  
lifeguard tower



防風フェンス  
bōfū fensu  
windbreak



遊歩道  
yūhodō  
promenade



デッキチェア  
dekki chea  
deck chair



サングラス  
sangurasu  
sunglasses



日除け帽  
hiyoke-bō  
sun hat



日焼けローション  
hiyake rōshon  
suntan lotion



日焼け止め  
hiyakedome  
sunblock



ビーチボール  
bīchi bōru  
beach ball



浮き輪  
ukiwa  
rubber ring

水着  
mizugi  
swimsuit

シャベル  
shaberu  
shovel

バケツ  
baketsu  
bucket



砂の城  
suna no shiro  
sandcastle

貝殻  
kaigara  
shell



ビーチタオル  
bīchi taoru  
beach towel



# キャンプ kyampu • camping



トイレ  
toire  
toilets

ゴミ置場  
gomi okiba  
waste disposal

シャワー棟  
shawā tō  
shower block

電源装置  
dengen sōchi  
electric hook-up

フライシート  
furaishīto  
flysheet

ペグ  
pegu  
tent peg

ロープ  
rōpu  
guy rope

キャンピングトレーラー  
kyampingu torērā  
camper

キャンプ場 kyampujō | campsite

## 関連用語 kanrenyōgo • vocabulary

キャンプする  
kyampu suru  
camp (v)

サイト  
saito  
pitch

ピクニックベンチ  
pikunikku benchi  
picnic bench

炭  
sumi  
charcoal

管理事務所  
kanri jimusho  
site manager's office

テントを張る  
tento o haru  
pitch a tent (v)

ハンモック  
hammokku  
hammock

着火剤  
chakka-zai  
firelighter

空きサイトあり  
aki saito ari  
pitches available

ポール  
pōru  
tent pole

キャンピングカー  
kyampingu kā  
camper van

火をつける  
hi o tsukeru  
light a fire (v)

空きなし  
aki nashi  
full

キャンプベッド  
kyampu beddo  
camp bed

トレーラー  
torērā  
trailer

キャンプファイヤー  
kyampufaiyā  
campfire





虫除け  
mushiyoke  
insect repellent



懐中電灯  
kaichūdentō  
flashlight

蚊帳  
kaya  
mosquito net



保温ウェア  
ho'on uea  
thermals



寝袋  
nebukuro  
sleeping bag



ハイキングブーツ  
haikingu bŭtsu  
hiking boots



雨具  
amagu  
rain slickers

マット  
matto  
sleeping mat



ガスコンロ  
gasu konro  
camping stove



バーベキュー  
bābekyū  
barbecue



エアーマットレス eā mattsuresu | air mattress

# 娯楽家電 goraku kaden • home entertainment



ポータブルCDプレーヤー  
pōtaburu shī-dī purēyā  
personal CD player



ミニディスクレコーダー  
mini disuku rekōdā  
mini disk recorder



MP3プレーヤー  
emu-pī-surī purēyā  
MP3 player

DVDディスク  
dī-bui-dī disuku  
DVD disk



DVDプレーヤー  
dī-bui-dī purēyā  
DVD player

CDプレーヤー  
shī-dī purēyā  
CD player

ラジオ  
rajio  
radio

アンプ  
ampu  
amplifier

ヘッドホン  
heddohon  
headphones

スタンド  
sutando  
stand

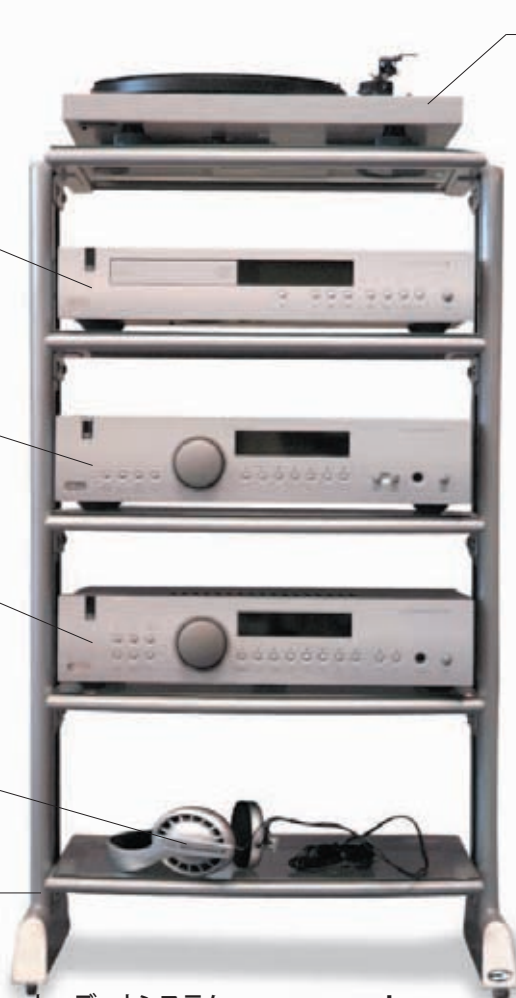

オーディオシステム ōdio shisutemu | hi-fi system

レコードプレーヤー  
rekōdo purēyā  
record player

(ラウド)スピーカー  
(raudo) supikā  
(loud) speaker



スピーカースタンド  
supikā sutando  
speaker stand

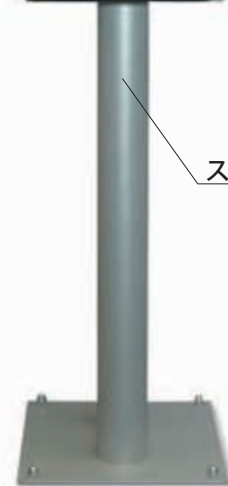

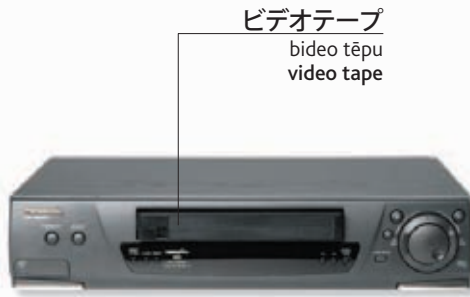

ビデオテープ  
bideo tēpu  
video tape

ビデオレコーダー  
bideo rekōdā  
video recorder



画面  
gamen  
screen

カムコーダー  
kamukōdā  
camcorder

アイカップ  
aikappu  
eyecup



衛星アンテナ  
eisei antena  
satellite dish

ワイド画面テレビ  
waido gamen terebi  
widescreen television



コントローラー  
kontorōrā  
controller

コンソール  
konsōru  
console



テレビゲーム terebi gēmu | video game

早送り  
hayaokuri  
fast forward

一時停止  
ichijiteishi  
pause

録画  
rokuga  
record



音量  
onryō  
volume

巻き戻し  
makimodoshi  
rewind

再生  
saisei  
play

停止  
teishi  
stop

リモコン rimokon | remote control

### 関連用語 kanrenyōgo • vocabulary

コンパクトディスク  
kompakuto disuku  
compact disk

長編映画  
chōhen eiga  
feature film

番組  
bangumi  
program

有料チャンネル  
yūryō channeru  
pay per view channel

テレビを見る  
terebi o miru  
watch television (v)

カセットテープ  
kasetto tēpu  
cassette tape

コマーシャル  
komāsharu  
advertisement

ステレオ  
sutereo  
stereo

チャンネルを替える  
channeru o kaeru  
change channel (v)

テレビを消す  
terebi o kesu  
turn the television off (v)

カセットプレーヤー  
kasetto purēyā  
cassette player

デジタル  
dijitaru  
digital

ケーブルテレビ  
kēburu terebi  
cable television

テレビを点ける  
terebi o tsukeru  
turn the television  
on (v)

ラジオをつける  
rajio o tsukeru  
tune the radio (v)



# 写真 shashin • photography

フィルムカウンター  
firumu kauntā  
frame counter

内蔵フラッシュ  
naizō furasshu  
flash

露出補正ダイヤル  
roshutsu hosei daiyaru  
aperture dial

シャッター  
shattā  
shutter release

シャッター速度摘み  
shattā sokudo tsumami  
shutter-speed dial



フィルター  
firutā  
filter



レンズキャップ  
renzu kyappu  
lens cap

レンズ  
renzu  
lens



三脚  
sankyaku  
tripod

一眼レフカメラ ichigan-refu kamera | SLR camera



フラッシュガン  
furasshu gan  
flash gun



露出計  
roshutsukei  
light meter



ズームレンズ  
zūmu renzu  
zoom lens

## カメラの種類 kamera no shurui • types of camera



デジタルカメラ  
dejitaru kamera  
digital camera



APSカメラ  
ē-pī-esu kamera  
APS camera



インスタントカメラ  
insutanto kamera  
instant camera



使い捨てカメラ  
tsukaisute kamera  
disposable camera

# 写真撮影 shashin satsuei • photograph



スプール  
supūru  
film spool

フィルム  
firumu  
film



ピントを合わせる  
pinto o awaseru  
focus (v)



現像する  
genzō suru  
develop (v)



ネガ  
nega  
negative

ランドスケープ  
randosukēpu  
landscape



写真 shashin | photograph

ポートレート  
pōtorēto  
portrait



アルバム  
arubamu  
photo album



写真用額縁  
shashin-yō gakubuchi  
photo frame

# 問題 mondai • problems



露出不足  
roshutsu-busoku  
underexposed



露出オーバー  
roshutsu-ōbā  
overexposed



ピンぼけ  
pimboke  
out of focus



赤目  
akame  
red eye

# 関連用語 kanrenyōgo • vocabulary

ファインダー  
faindā  
viewfinder

カメラケース  
kamera kēsu  
camera case

露出  
roshutsu  
exposure

暗室  
anshitsu  
darkroom

メモ리카ード  
memori kādo  
memory card

印画  
inga  
print

無光沢  
mukōtaku  
matte

光沢  
kōtaku  
gloss

引き伸ばし  
hikinobashi  
enlargement

印画紙  
ingashi  
photo paper

このフィルムを現像してください。  
kono firumu o genzō shite kudasai.  
I'd like this film processed.

# ゲーム gēmu • games

チェス盤  
chesuban  
chessboard

黒  
kuro  
black

白  
shiro  
white

クイーン  
kuin  
queen

キング  
kingu  
king

ポーン  
pōn  
pawn

ナイト  
naito  
knight

ビショップ  
bishoppu  
bishop

ルーク  
rūku  
rook

升目  
masume  
square

チェス  
chesu  
chess

駒  
koma  
tile

駒  
koma  
piece

スクラブル  
sukuraburu | scrabble

チェッカー  
chekkā  
checkers

さいころ  
saikoro  
dice

駒  
koma  
counter

モノポリー  
monopoli  
monopoly

バックギャモン  
bakkugyamon | backgammon

盤上ゲーム  
banjō gēmu | board games





切手収集 kitte shūshū  
stamp collecting



ジグソーパズル jigusō pazuru  
jigsaw puzzle

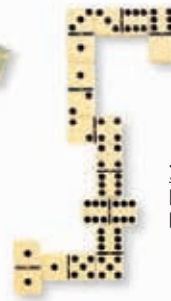

ドミノ domino  
dominoes

ダーツボード  
datsubōdo  
dartboard

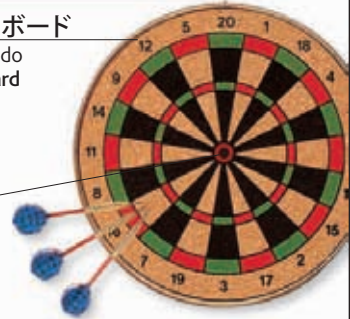

金的  
kinteki  
bullseye

ダーツ dātsu | darts

ジョーカー  
jōkā  
joker

ジャック  
jakku  
jack

クイーン  
kuin  
queen

キング  
kingu  
king

エース  
ēsu  
ace

トランプ torampu | cards



ダイヤ  
daiya  
diamond

スペード  
supēdo  
spade

ハート  
hāto  
heart

クラブ  
kurabu  
club



切る kiru | shuffle (v)



配る kubaru | deal (v)

関連用語 kanrenyōgo • vocabulary

手  
te  
move

勝つ  
katsu  
win (v)

敗者  
haisha  
loser

点  
ten  
point

ブリッジ  
burijji  
bridge

さいころを転がしてください。  
saikoro o korogashite kudasai.  
Roll the dice.

遊ぶ  
asobu  
play (v)

勝者  
shōsha  
winner

ゲーム  
gēmu  
game

得点  
tokuten  
score

トランプ一組  
torampu hito-kumi  
deck of cards

誰の番ですか。  
dare no ban desuka?  
Whose turn is it?

プレーヤー  
purēyā  
player

負ける  
makeru  
lose (v)

賭け  
kake  
bet

ポーカー  
pōkā  
poker

スーツ  
sūto  
suit

貴方の番です。  
anata no ban desu.  
It's your move.

# 美術と工芸1 bijutsu to kōgei • arts and crafts 1



画家  
gaka  
artist

絵  
e  
painting

イーゼル  
īzeru  
easel

キャンバス  
kyambasu  
canvas

絵筆  
efude  
brush

パレット  
paretto  
palette

図画 zuga | painting

## 絵具 enogu • paints



油絵具  
abura enogu  
oil paints



水彩絵具  
suisai enogu  
watercolor paint



パステル  
pasuteru  
pastels



アクリル絵具  
akuriru enogu  
acrylic paint



ポスターカラー posutā karā  
poster paint

## 色 iro • colours



赤 aka | red



青 ao | blue



黄色 ki'iro  
yellow



緑 midori | green



オレンジ色 orenji iro  
orange



紫 murasaki  
purple



白 shiro | white



黒 kuro | black

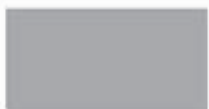

灰色 hai'iro | gray



ピンク pinku  
pink



茶色 chairo | brown



藍色 ai'iro  
indigo

# 他の工芸 ta no kōgei • other crafts

スケッチブック  
suketchi bukku  
sketch pad

鉛筆  
empitsu  
pencil

スケッチ  
suketchi  
sketch

インク  
inku  
ink

木炭  
mokutan  
charcoal

素描 sobyō | drawing



版画 hanga | printing



エッチング etching  
engraving

石材  
sekizai  
stone

木槌  
kizuchi  
mallet

彫刻刀  
chōkokutō  
chisel

木材  
mokuzai  
wood

彫刻  
chōkoku  
sculpting

木工  
mokkō  
woodworking



成形道具  
seikei dōgu  
modeling tool

ロクロ  
rokuro  
potter's wheel

粘土  
nendo  
clay

陶芸 tōgei | pottery

糊  
nori  
glue

厚紙  
atsugami  
cardboard

コラージュ korāju | collage



ジュエリー制作  
juerī seisaku  
jewellery making



張子  
hariko  
papier-mâché



折り紙  
origami  
origami



模型制作  
mokei seisaku  
model making



# 美術と工芸2 bijutsu to kōgei • arts and crafts 2



ミシン mishin | sewing machine



鋏  
hasami  
scissors



型紙  
katagami  
pattern



針刺し  
harisashi  
pincushion

待針  
nachibari  
pin

裁縫箱 sai-hō-bako  
sewing basket



メジャー  
mejā  
tape measure



生地  
kiji  
material



ボビン  
bobin  
bobbin



糸  
ito  
thread



受け金  
ukegane  
eye

受け金  
ukegane  
eye



指貫  
yubinuki  
thimble



チャコ  
chako  
tailor's chalk



ダミー  
dami  
tailor's dummy



糸を通す  
ito o tōsu  
thread (v)



縫う  
nu'u  
sew (v)

縫い目  
nuime  
stitch



繕う  
tsukurō  
darn (v)



仮縫いする  
karinui suru  
tack (v)



切る  
kiru  
cut (v)



ニードルポイント  
nidorupointo  
needlepoint



刺繍  
shishū  
embroidery

かぎ針  
kagibari  
crochet hook



かぎ針編み  
kagibariami  
crochet



マクラメ  
makurame  
macramé



パッチワーク  
patchiwāku  
patchwork



キルティング  
kirutingu  
quilting



レース用ボビン  
rēsu-yō bobin  
lace bobbin

レース編み  
rēsuami  
lace-making



機  
hata  
loom

機織り  
hataori  
weaving



編み針  
amibari  
knitting needle

編み物 amimono | knitting



毛糸  
keito  
wool

かせ kase | skein

関連用語 kanrenyōgo •  
vocabulary

ほどく  
hodoku  
unpick (v)

ナイロン  
nairon  
nylon

布地  
nunoji  
fabric

絹  
kinu  
silk

綿  
men  
cotton

デザイナー  
dezainā  
designer

リネン  
rinen  
linen

ファッション  
fashon  
fashion

ポリエステル  
poriesuteru  
polyester

ファスナー  
fasunā  
zip









環境 kankyō  
environment





# 宇宙空間 uchūkūkan • space

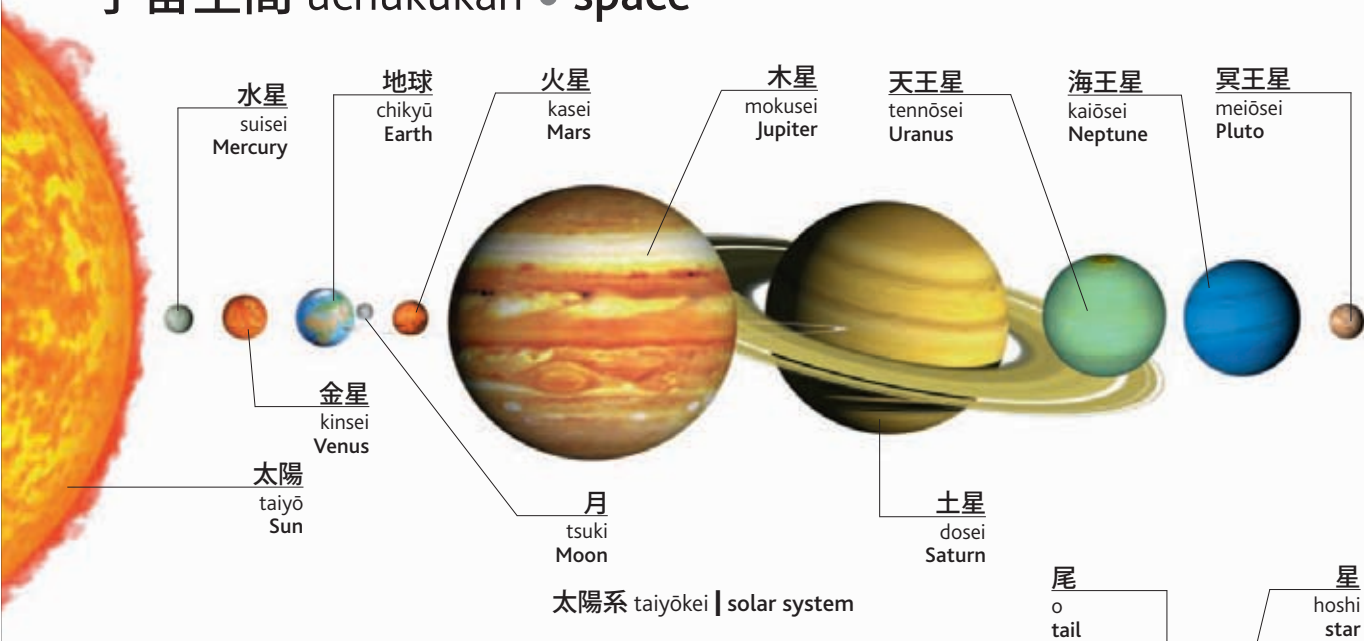

銀河系  
gingakei  
galaxy

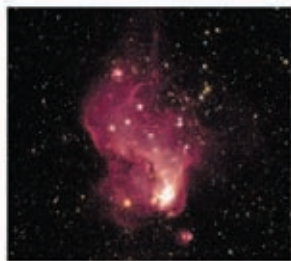

星雲  
seiun  
nebula



小惑星  
shōwakusei  
asteroid



彗星  
suisei  
comet

## 関連用語 kanrenyōgo • vocabulary

|                          |                                       |                                  |
|--------------------------|---------------------------------------|----------------------------------|
| 宇宙<br>uchū<br>universe   | ブラックホール<br>burakku hōru<br>black hole | 満月<br>mangetsu<br>full moon      |
| 軌道<br>kidō<br>orbit      | 惑星<br>wakusei<br>planet               | 新月<br>shingetsu<br>new moon      |
| 重力<br>jūryoku<br>gravity | 流星<br>ryūsei<br>meteor                | 三日月<br>mikazuki<br>crescent moon |



食 shoku | eclipse

## 宇宙探検 uchū tanken • space exploration

スペースシャトル  
supēsu shatoru  
space shuttle

ブースター  
būsutā  
booster



発射  
hassha  
launch

宇宙服  
uchūfuku  
space suit



宇宙飛行士 uchūhikōshi  
astronaut

スラスタ  
surasutā  
thruster

発射台  
hasshadai  
launch pad

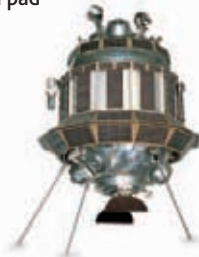

人工衛星  
jinkōisei  
satellite

レーダー  
rēdā  
radar

乗船口  
jōsen-guchi  
crew hatch

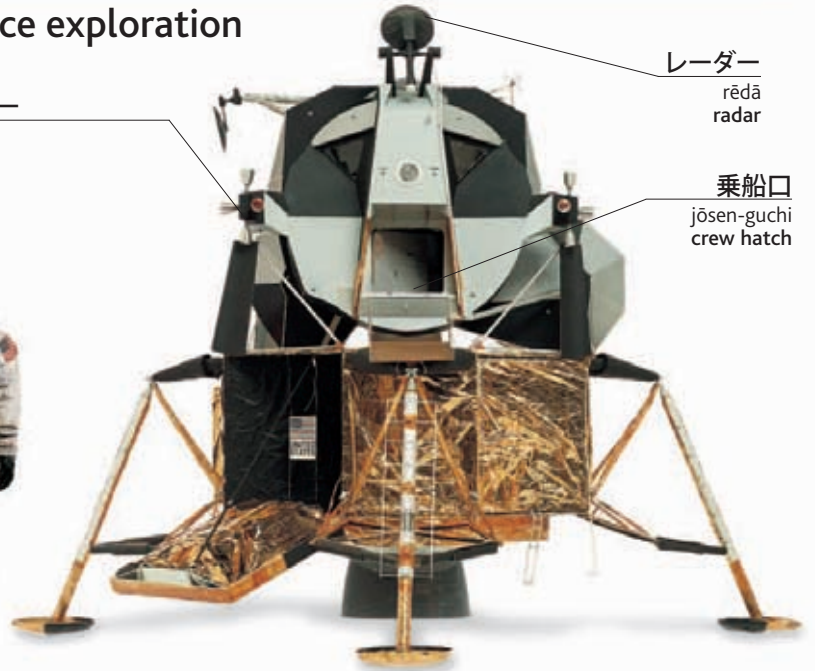

月着陸船 tsukichakurikusen | lunar module



宇宙ステーション  
uchū sutēshon  
space station

## 天文学 tenmongaku • astronomy



星座  
seiza  
constellation



双眼鏡  
sōgankyō  
binoculars

天体望遠鏡  
tentaibōenkyō  
telescope

三脚  
sankyaku  
tripod





# 地球 chikyū • Earth

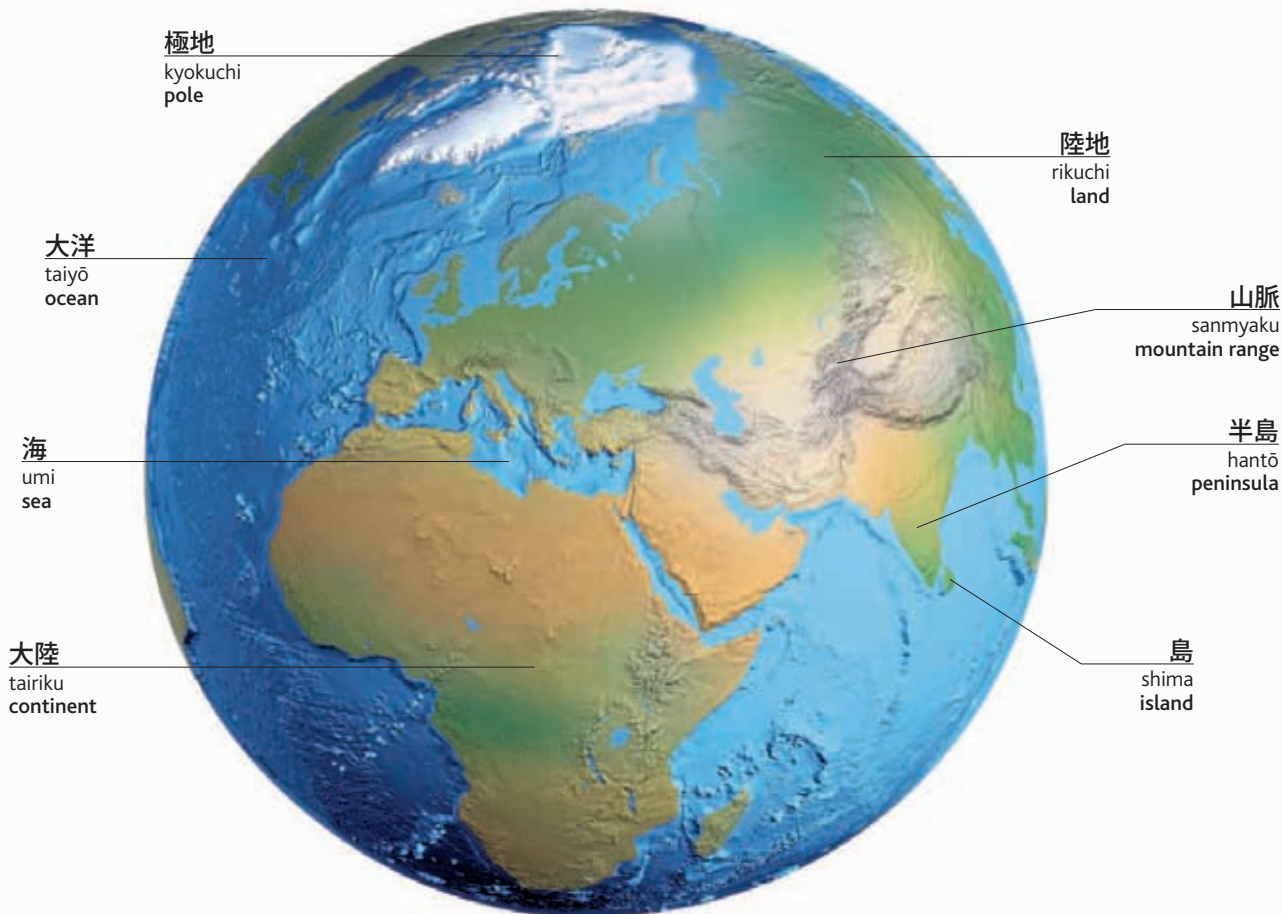

惑星 wakusei | planet

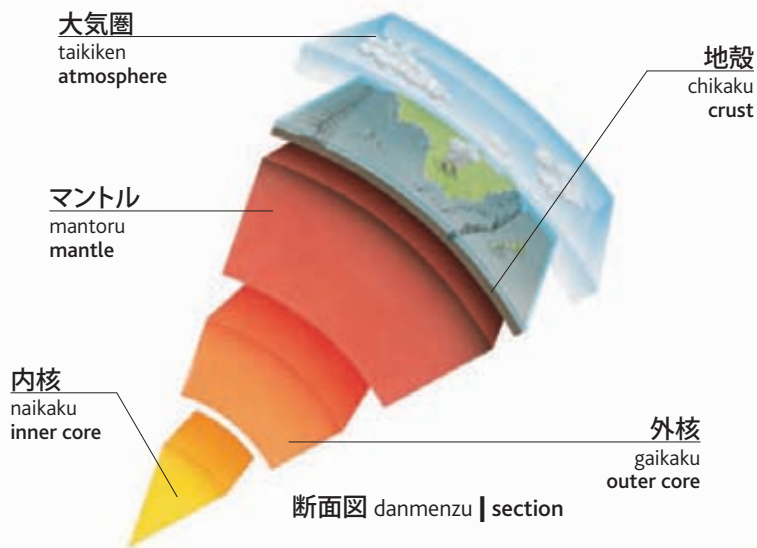

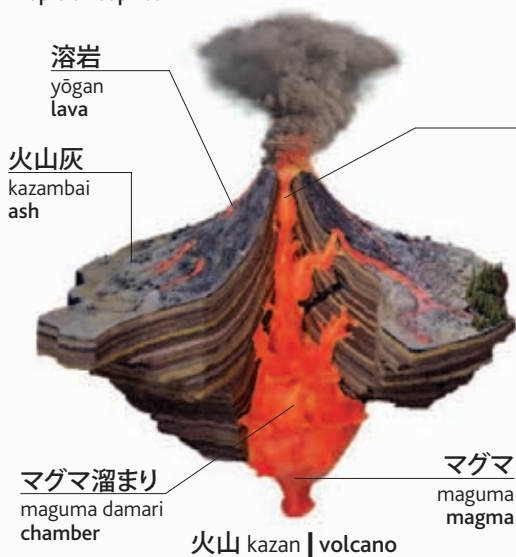
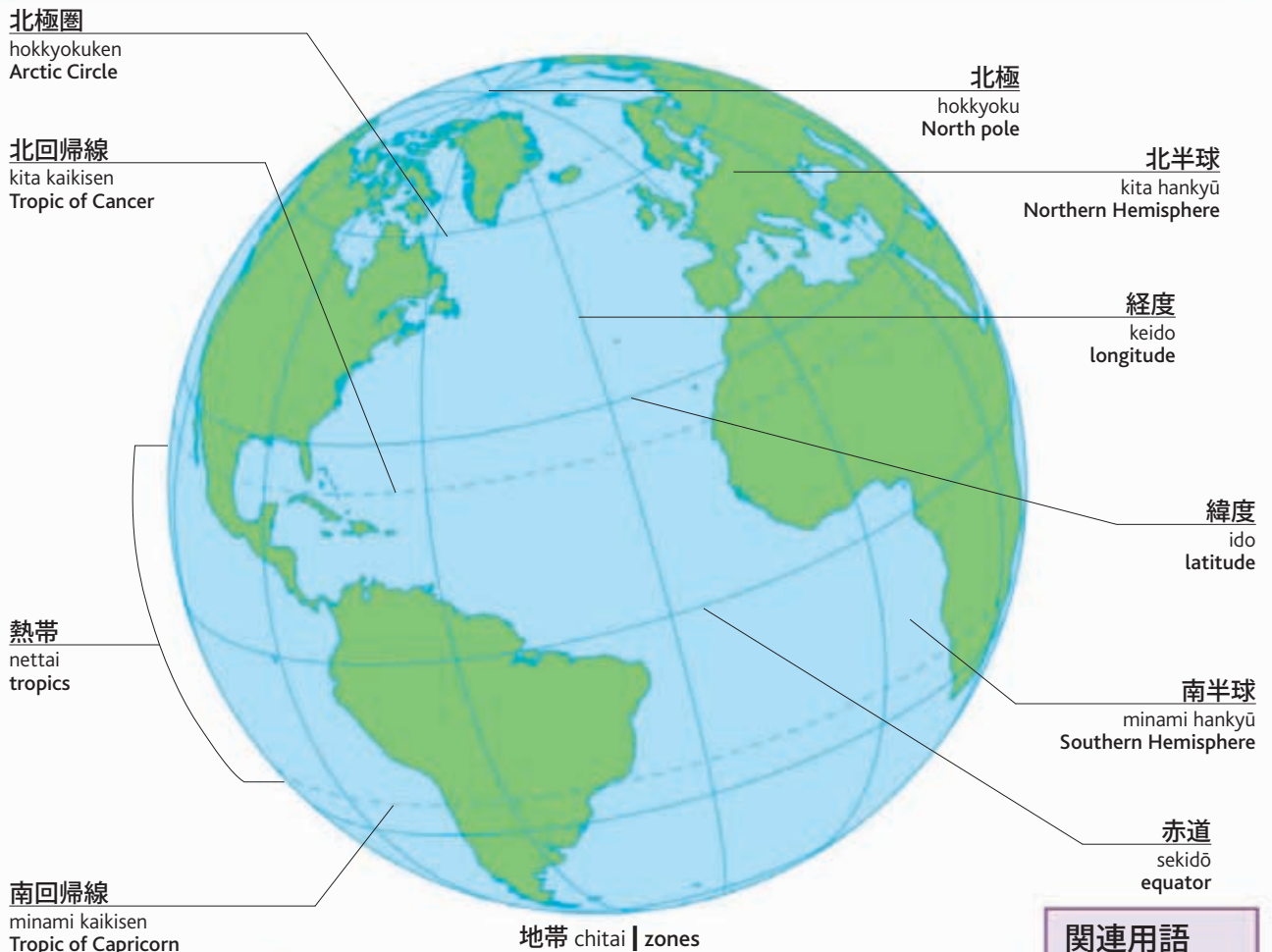

噴火口 funkakō | crater

関連用語  
kanrenyōgo •  
vocabulary

地震  
jishin  
earthquake

プレート  
purēto  
plate

噴火する  
funka suru  
erupt (v)

微震  
bishin  
tremor



# 地勢 chisei • landscape

山  
yama  
mountain

斜面  
shamen  
slope

川岸  
kawagishi  
bank

川  
kawa  
river

急流  
kyūryū  
rapids

岩  
iwa  
rocks



氷河  
hyōga  
glacier



谷間 tanima | valley



丘陵  
kyūryō  
hill



台地  
daichi  
plateau



溪谷  
keikoku  
gorge



洞窟  
dōkutsu  
cave





平野 heiya | plain



砂漠 sabaku | desert



森林 shinrin | forest



林地 rinchi | wood



雨林  
urin  
rain forest



湿地  
shitchi  
swamp



草地  
kusachi  
meadow



草原  
sōgen  
grassland



滝  
taki  
waterfall



溪流  
keiryū  
stream



湖  
mizu'umi  
lake



間欠泉  
kanketsusen  
geyser



海岸  
kaigan  
coast



崖  
gake  
cliff



珊瑚礁  
sangoshō  
coral reef



河口  
kakō  
estuary

# 気象 kishō • weather

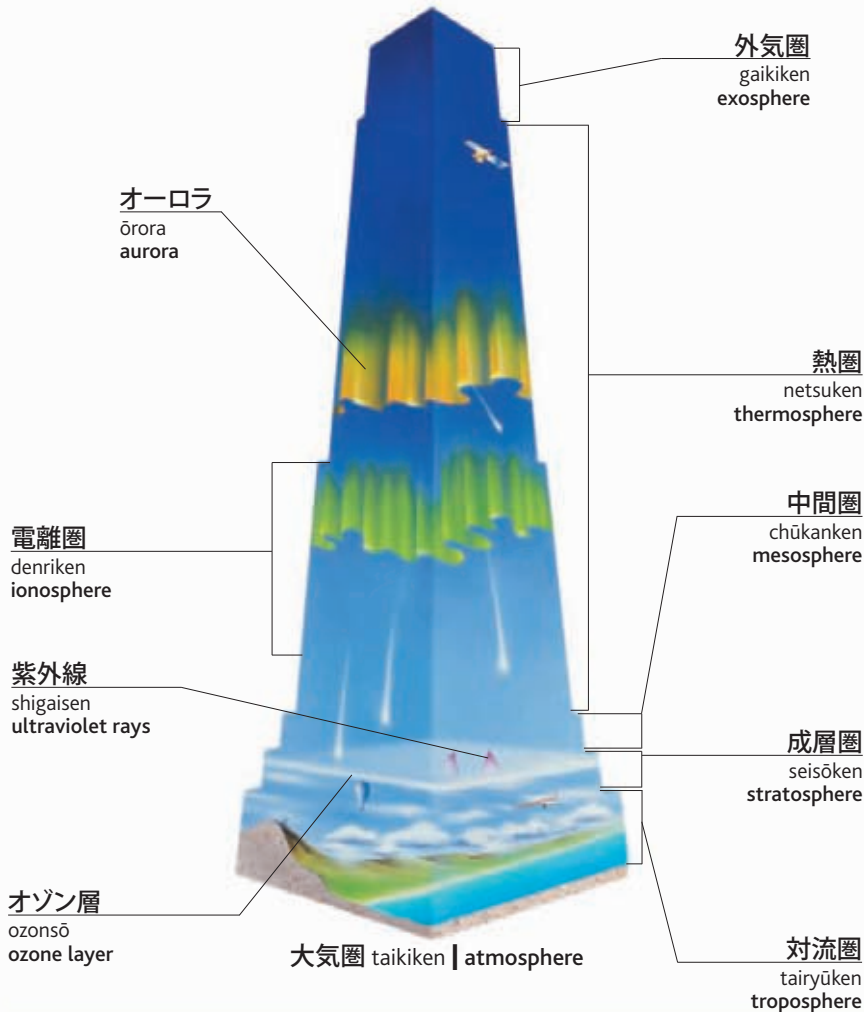

晴天 seiten | sunshine



風 kaze | wind

## 関連用語 kanrenyōgo • vocabulary

霰  
mizore  
sleet

晴れ  
hare  
sunny

寒い  
samui  
cold

雨がちな  
ame-gachi na  
wet

強風  
kyōfū  
gale

暑い/寒いです。  
atsui/samui desu.  
I'm hot/cold.

雹  
hyō  
hail

曇り  
kumori  
cloudy

暖かい  
ataakai  
warm

湿気が多い  
shikke no ōi  
humid

気温  
kion  
temperature

雨が降っています。  
ame ga futte imasu.  
It's raining.

雷  
kaminari  
thunder

暑い  
atsui  
hot

乾燥した  
kansō  
shita  
dry

風の強い  
kaze no  
tsuyoi  
windy

台風  
taifū  
typhoon

... 度です。  
... do desu.  
It's ... degrees.





雲 kumo | cloud



雨 ame | rain

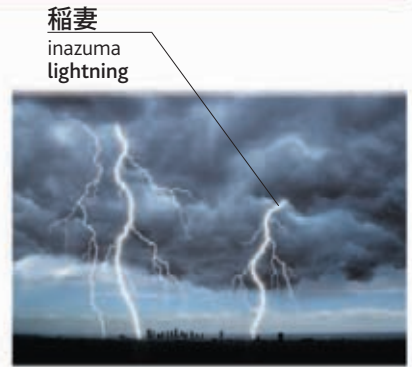

稲妻  
inazuma  
lightning

嵐 arashi | storm



靄 moya | mist



霧 kiri | fog



虹 niji | rainbow



雪 yuki | snow



霜 shimo | frost



氷 kōri | ice



氷柱  
tsurara  
icicle

氷結 hyōketsu | freeze



ハリケーン harikēn  
hurricane



旋風 tsumujikaze  
tornado



モンスーン monsun  
monsoon



洪水 kōzui | flood



## 岩石 ganseki • rocks

### 火成岩 kaseigan • igneous



花崗岩  
kakōgan  
granite



黒曜石  
kokuyōseki  
obsidian



玄武岩  
gembagan  
basalt



軽石  
karuishi  
pumice

### 堆積岩 taisekigan • sedimentary



砂岩  
sagan  
sandstone



石灰岩  
sekkaigan  
limestone



白亜  
hakua  
chalk



燧石  
suiseki  
flint



礫岩  
rekigan  
conglomerate



石炭  
sekitan  
coal

### 変成岩 henseigan • metamorphic



粘板岩  
nembangan  
slate



片岩  
hengan  
schist



片麻岩  
henmagan  
gneiss



大理石  
dairiseki  
marble

### 宝石 hōseki • gems

ルビー  
rubī  
ruby



アクアマリン  
akuamarin  
aquamarine



アメジスト  
amejisuto  
amethyst



ダイヤモンド  
daiyamondo  
diamond



翡翠  
hisui  
jade



ジェット  
jetto  
jet



エメラルド  
emerarudo  
emerald



オパール  
opāru  
opal



サファイア  
safaiia  
sapphire



ムーンストーン  
mūnsutōn  
moonstone

ガーネット  
gānetto  
garnet

トパーズ  
topāzu  
topaz

トルマリン  
torumarin  
tourmaline

## 鉱石 kōseki • minerals



石英  
sekiei  
quartz



雲母  
unmo  
mica



硫黄  
iō  
sulfur



ヘマタイト  
hemataito  
hematite



方解石  
hōkaiseki  
calcite



孔雀石  
kujakuseki  
malachite



トルコ石  
torukoishi  
turquoise



縞瑪瑙  
shimamenō  
onyx



瑪瑙  
menō  
agate



黒鉛  
kokuen  
graphite

## 金属 kinzoku • metals



金  
kin  
gold



銀  
gin  
silver



プラチナ  
purachina  
platinum



ニッケル  
nikkeru  
nickel



鉄  
tetsu  
iron



銅  
dō  
copper



錫  
suzu  
tin



アルミニウム  
aruminiumu  
aluminum



水銀  
suigin  
mercury



亜鉛  
aen  
zinc

# 動物1 dōbutsu • animals 1

## 哺乳類 honyūri • mammals



兎  
usagi  
rabbit



ハムスター  
hamusutā  
hamster

髭  
hige  
whiskers



二十日鼠  
hatsukanezumi  
mouse



尾  
o  
tail

鼠  
nezumi  
rat



針鼠  
harinezumi  
hedgehog



栗鼠  
risu  
squirrel



蝙蝠  
kōmori  
bat



狸  
tanuki  
raccoon



狐  
kitsune  
fox



狼  
ōkami  
wolf

子犬  
koinu  
puppy



犬  
inu  
dog

子猫  
koneko  
kitten



猫  
neko  
cat

子海豹  
ko-azarashi  
pup



獺  
kawauso  
otter



海豹  
azarashi  
seal



海驢  
ashika  
sea lion

ひれ足  
hire ashi  
flipper



海象  
seiuchi  
walrus

噴気孔  
funkikō  
blowhole



鯨  
kujira  
whale



海豚  
iruka  
dolphin





枝角 鬣  
eda tsuno antler  
tategami mane

鹿  
shika  
deer

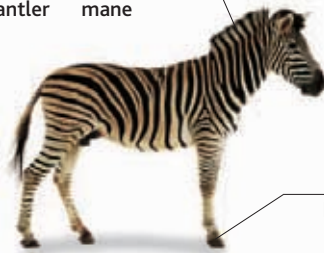

蹄  
hizume  
hoof

縞馬  
shimauma  
zebra



麒麟  
kirin  
giraffe



こぶ  
kobu  
hump

駱駝  
rakuda  
camel



河馬  
kaba  
hippopotamus

鼻  
hana  
trunk



牙  
kiba  
tusk

象  
zō  
elephant



角  
tsuno  
horn

犀  
sai  
rhinoceros



虎  
tora  
tiger

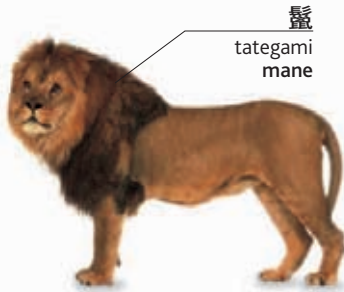

鬣  
tategami  
mane

ライオン  
raion  
lion



猿  
saru  
monkey



ゴリラ  
gorira  
gorilla



コアラ  
koara  
koala



袋  
fukuro  
pouch

カンガルー  
kangarū  
kangaroo



熊  
kuma  
bear

爪  
tsume  
claw



北極熊  
hokkyokuguma  
polar bear

パンダ  
panda  
panda



# 動物2 dōbutsu • animals 2

## 鳥類 chōrui • birds



カナリヤ  
kanariya  
canary



雀  
suzume  
sparrow



蜂鳥  
hachidori  
hummingbird



燕  
tsubame  
swallow



烏  
karasu  
crow



鳩  
hato  
pigeon



啄木鳥  
kitsutsuki  
woodpecker



隼  
hayabusa  
falcon



梟  
fukurō  
owl



鷗  
kamome  
gull



鷲  
washi  
eagle



ペリカン  
perikan  
pelican



フラミンゴ  
furamingo  
flamingo



鶴  
kōnotori  
stork



鶴  
tsuru  
crane



ペンギン  
pengin  
penguin



駝鳥  
dachō  
ostrich





鶩鳥 gachō | goose



白鳥 hakuchō swan



孔雀 kujaku peacock



雉 kiji pheasant



七面鳥 shichimenchō turkey



鸚哥 inko cockatoo

嘴 kuchibashi bill

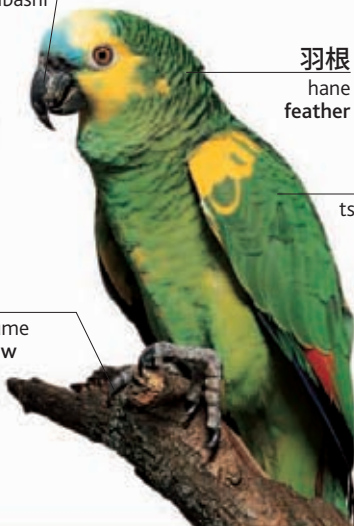

羽根 hane feather

翼 tsubasa wing

爪 tsume claw

鸚鵡 ōmu parrot

## 爬虫類 hachūruī • reptiles

鱗 uroko scales



アリゲーター arigētā alligator



蜥蜴 tokage lizard

イグアナ iguana iguana



甲羅 kōra shell

亀 kame turtle

陸亀 riku-game tortoise

蛇 hebi snake



鼻 hana snout



クロコダイル kurokodairu crocodile



# 動物3 dōbutsu • animals 3

## 両生類 ryōseirui • amphibians



蛙  
kaeru  
frog



蟾蛙  
hikigaeru  
toad



おたまじゃくし  
otamajakushi  
tadpole



山椒魚  
sanshō'uo  
salamander

## 魚類 gyorui • fish



鰻  
unagi  
eel

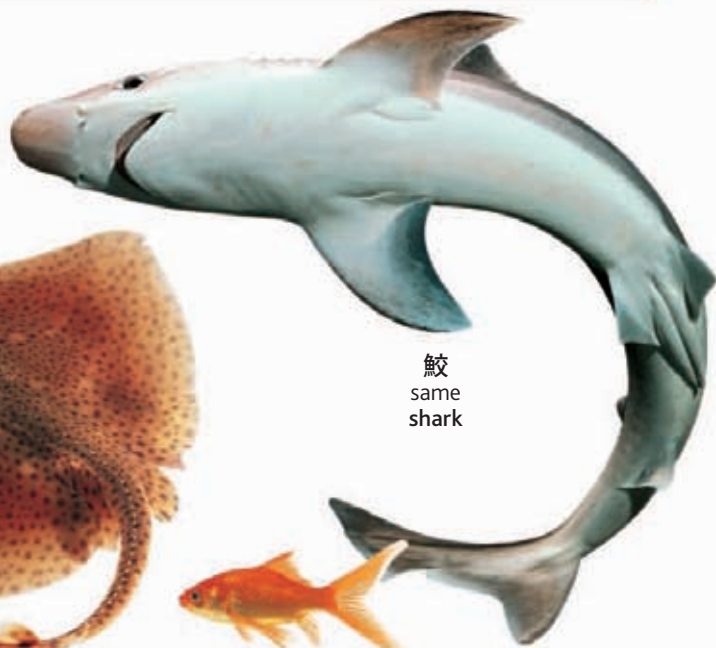

鮫  
same  
shark



竜の落とし子  
tatsu-no-otoshigo  
seahorse



雁木鱈  
gangiei  
skate

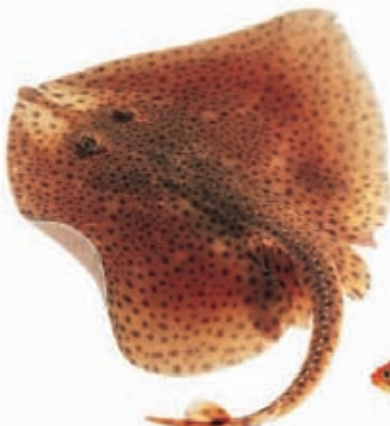

海鰻魚  
ei  
ray



金魚  
kingyo  
goldfish



女梶木 mekajiki | swordfish

背鰭  
sebire  
dorsal fin

胸鰭  
munabire  
pectoral fin

尾  
o  
tail

鰓  
era  
gill

鱗  
uroko  
scale

鯉 koi | koi carp

無脊椎動物 musekitsu dōbutsu • invertebrates



蟻  
ari  
ant



白蟻  
shiroari  
termite



蜜蜂  
mitsubachi  
bee



蜂  
hachi  
wasp



甲虫  
kabutomushi  
beetle



ゴキブリ  
gokiburi  
cockroach



蛾  
ga  
moth



蝶  
chō  
butterfly

触角  
shokkaku  
antenna



繭  
mayu  
cocoon



芋虫  
imomushi  
caterpillar



蟋蟀 kōrogi | cricket



蝗  
inago  
grasshopper



螳螂  
kamakiri  
praying mantis



毒針  
dokubari  
sting



百足  
mukade  
centipede



蜻蛉  
tombo  
dragonfly



蠅  
hae  
fly



蚊  
ka  
mosquito



天道虫  
tentōmushi  
ladybug



蜘蛛  
kumo  
spider



蛞蝓  
namekuji  
slug



蝸牛  
katatsumuri  
snail



蚯蚓 mimizu | worm



海星  
hitode  
starfish



紫貽貝  
murasaki igai  
mussel



蟹 kani | crab



ロブスター robusutā  
lobster



蛸 tako | octopus



烏賊 ika | squid



水母 kurage | jellyfish



# 植物 shokubutsu • plants

## 木 ki • tree

枝  
eda  
branch

根  
ne  
root

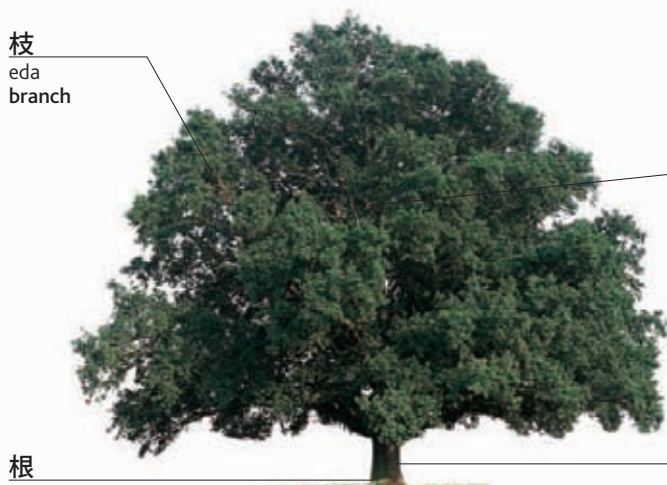

樅 kashi | oak



唐松  
karamatsu  
larch



ブナ  
buna  
beech



白樺  
shirakaba  
birch



楓  
kaede  
maple



榆  
nire  
elm



リンデン  
rinden  
linden



樹皮  
juhi  
bark



葉  
ha  
leaf

小枝  
koeda  
twig

幹  
miki  
trunk



ポプラ  
popura  
poplar



柳  
yanagi  
willow



ユーカリ  
yūkari  
eucalyptus



松  
matsu  
pine



ヒマラヤ杉  
himarayasugi  
cedar

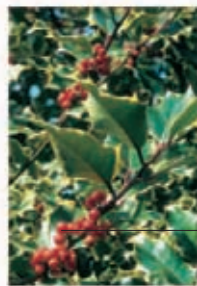

柵  
hi'iragi  
holly

実  
mi  
berry



椰子  
yashi  
palm



顕花植物 kenkashokubutsu • flowering plant

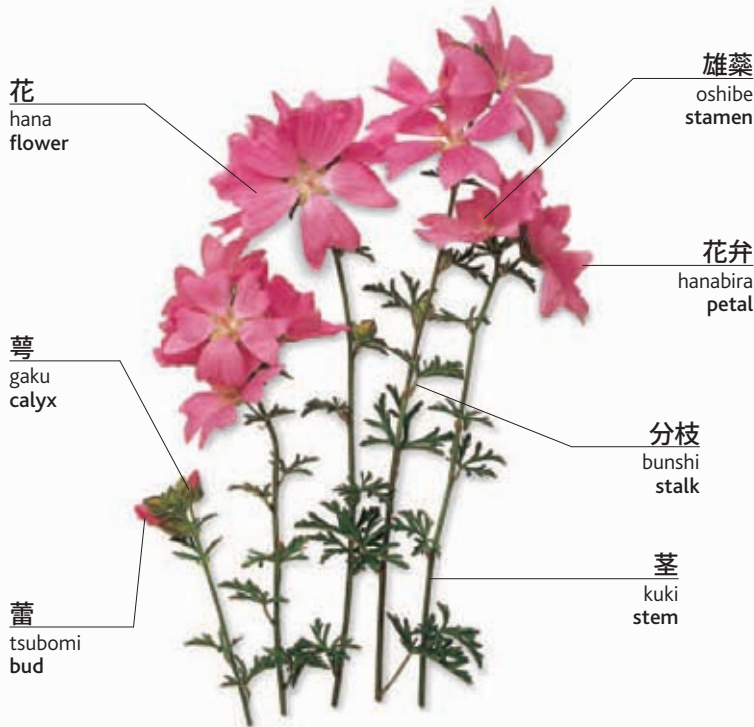

金鳳花  
kimpōge  
buttercup



雛菊  
hinagiku  
daisy



薊  
azami  
thistle



蒲公英  
tampopo  
dandelion



ヒース  
hīsu  
heather



芥子  
keshi  
poppy



狐の手袋  
kitsune-no-tebukuro  
foxglove



忍冬  
suikazura  
honeysuckle



向日葵  
himawari  
sunflower



クローバー  
kurōbā  
clover



釣鐘水仙  
tsurigane suisen  
bluebells



桜草  
sakurasō  
primrose



ルーピン  
rūpin  
lupins



刺草  
irakusa  
nettle



# 市街 shigai • town

通り  
tōri  
street

縁石  
fuchi'ishi  
curb

街角  
machikado  
street corner

商店  
shōten  
store



交差点  
kōsaten  
intersection

一方通行  
ippōtsūkō  
one-way street

歩道  
hodō  
pavement

オフィスビル  
ofisu biru  
office building

マンション  
manshon  
apartment  
building

路地  
roji  
alley

駐車場  
chūshajō  
parking lot

道路標識  
dōro hyōshiki  
street sign

ポラード  
borādo  
traffic post

街灯  
gaitō  
street light

## 建物 tatemono • buildings



市庁舎  
shichōsha  
town hall



図書館  
toshokan  
library



映画館  
eigakan  
movie theater



劇場  
gekijō  
theater



大学  
daigaku  
university



摩天楼  
matenrō  
skyscraper

## 区域 kuiki • areas



工業団地  
kōgyōdanchi  
industrial complex



都市  
toshi  
city



学校  
gakkō  
school



郊外  
kōgai  
suburb



村  
mura  
village

## 関連用語 kanrenyōgo • vocabulary

歩行者天国  
hokōsha-tengoku  
pedestrian zone

脇道  
wakimichi  
side street

マンホール  
manhōru  
manhole

排水溝  
haisuikō  
gutter

教会  
kyōkai  
church

大通り  
ōdōri  
avenue

広場  
hiroba  
square

バス停  
basutei  
bus stop

工場  
kōjō  
factory

下水道  
gesuidō  
drain



# 建築 kenchiku • architecture

## 建物と構造 tatemono to kōzō • buildings and structures



摩天楼  
matenrō  
skyscraper



城  
shiro  
castle



教会  
kyōkai  
church

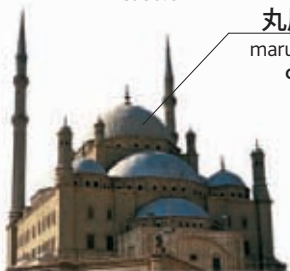

モスク  
mosuku  
mosque



寺院  
ji'in  
temple



シナゴグ  
shinagōgu  
synagogue



ダム  
damu  
dam



橋  
hashi  
bridge

小塔 尖塔  
shōtō sentō  
turret spire

濠  
hori  
moat

破風  
hafu  
gable

丸屋根  
maruyane  
dome

塔  
tō  
tower

アーチ形屋根  
āchi-gata yane  
vault

コーニス  
kōnisu  
cornice

柱  
hashira  
pillar

頂華  
chōge  
finial

大聖堂 daiseidō | cathedral



建築様式 kenchiku yōshiki • styles



ゴシック goshikku | gothic

アーキトレーブ  
ākitorēbu  
architrave



ルネサンス  
runesansu  
Renaissance



バロック  
barokku  
baroque



アーチ  
āchi  
arch

フリーズ  
furīzu  
frieze

聖歌隊席  
seikatai seki  
choir



ロココ  
rokoko  
rococo

ペディメント  
pedimento  
pediment



控え壁  
hikaekabe  
buttress

新古典主義  
shinkotenshugi  
neoclassical



アールヌーボー  
āru nūbō  
art nouveau



アールデコ  
āru deko  
art deco



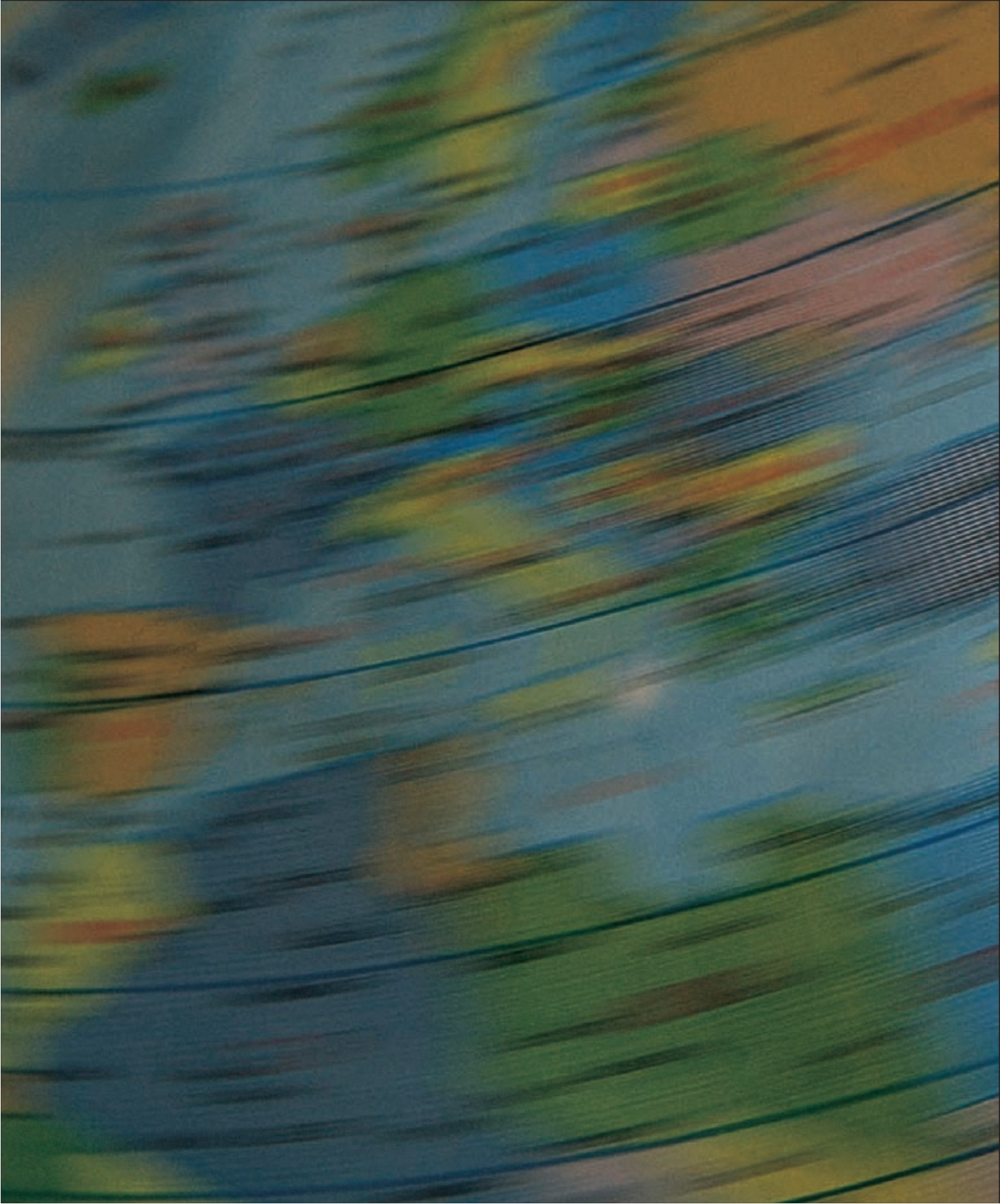

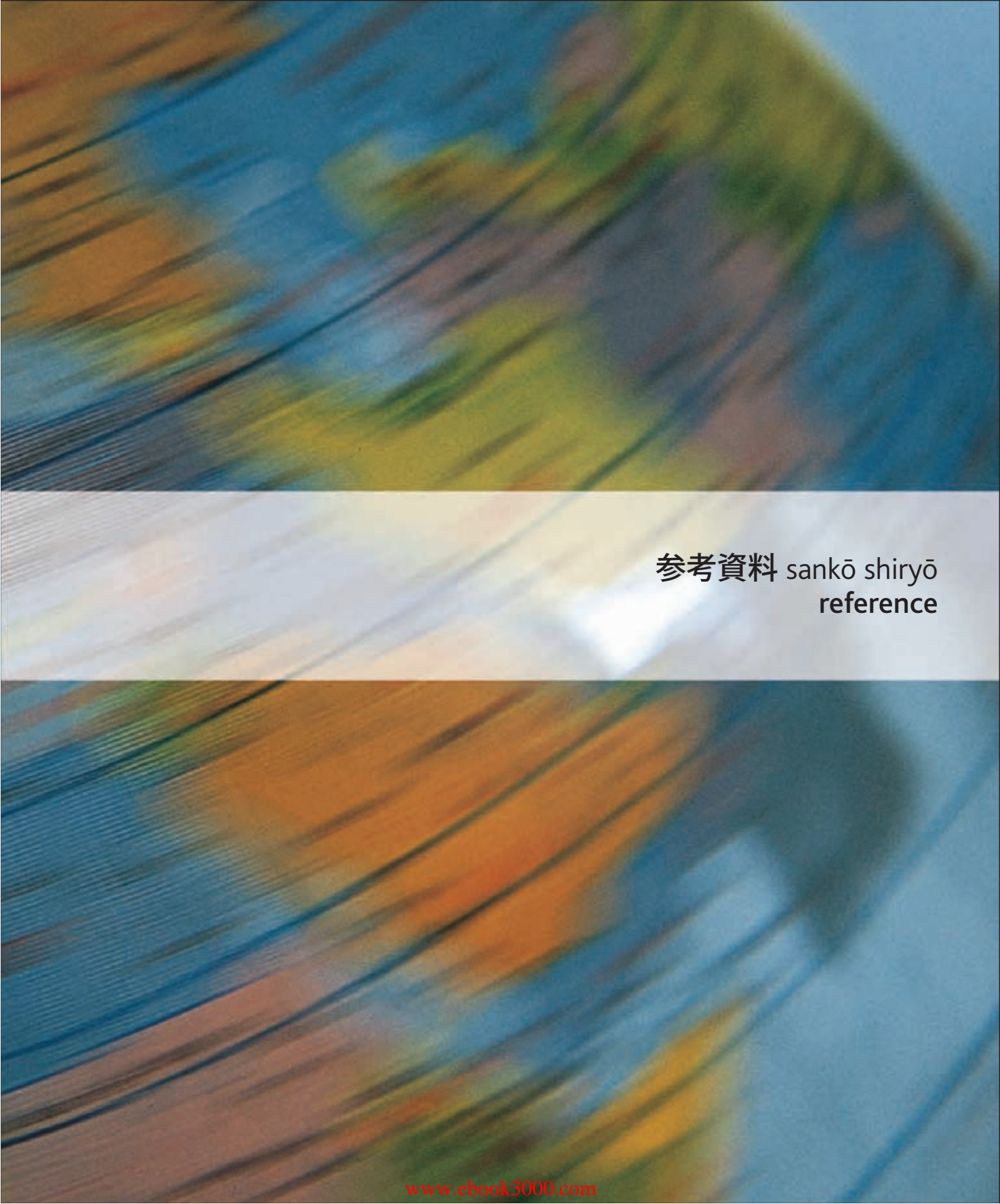

The background of the page is a stylized, slightly blurred image of a globe. The globe is oriented vertically, showing the Americas on the left and the Asia/Australia region on the right. A prominent white horizontal band runs across the center of the globe, creating a clear space for text. The colors of the globe are muted, with shades of blue, green, and brown.

参考資料 sankō shiryō  
reference

# 時間 jikan • time

長針  
chōshin  
minute hand

短針  
tanshin  
hour hand



時計  
tokei  
clock

## 関連用語 kanrenyōgo • vocabulary

|                    |                                  |   |
|--------------------|----------------------------------|---|
| 秒<br>byō<br>second | 現在<br>genzai<br>now              | 15分<br>jūgo-fun<br>a quarter of an hour |
| 分<br>fun<br>minute | 後<br>nochi<br>later              | 20分<br>nijūppun<br>twenty minutes       |
| 時<br>ji<br>hour    | 30分<br>sanjūppun<br>half an hour | 40分<br>yonjūppun<br>forty minutes       |

今、何時ですか。  
ima nanji desuka?  
What time is it?

3時です。  
san-ji desu.  
It's three o'clock.



1時5分  
ichi-ji go-fun  
five past one



1時10分  
ichi-ji jūppun  
ten past one



1時15分  
ichi-ji jūgo-fun  
quarter past one



1時20分  
ichi-ji nijūppun  
twenty past one



1時25分  
ichi-ji nijūgo-fun  
twenty five past one

秒針  
byōshin  
second hand



1時半  
ichi-ji han  
one thirty



1時35分  
ichi-ji sanjūgo-fun  
twenty five to two



1時40分前  
ichi-ji yonjūppun  
twenty to two



2時15分前  
ni-ji jūgo-fun mae  
quarter to two



2時10分前  
ni-ji jūppun mae  
ten to two



2時5分前  
ni-ji go-fun mae  
five to two



2時  
ni-ji  
two o'clock

# 日中と夜 nitchū to yoru • night and day



真夜中 mayonaka | midnight



日の出 hinode | sunrise



夜明け yoake | dawn



朝 asa | morning



日没  
nichibotsu  
sunset



正午  
shōgo  
midday



夕暮れ yūgure | dusk



晩 ban | evening



午後 gogo | afternoon

## 関連用語 kanrenyōgo • vocabulary

早い  
hayai  
early

早いですね。  
hayai desune.  
You're early.

時間通りに来てください。  
jikan-dōri ni kite kudasai.  
Please be on time.

何時に終わりますか。  
nanji ni owarimasuka?  
What time does it finish?

時間通り  
jikan-dōri  
on time

遅刻です。  
chikoku desu.  
You're late.

また後で。  
mata ato de.  
I'll see you later.

遅くなってきました。  
osokunatte kimashita.  
It's getting late.

遅い  
osoi  
late

もうすぐ到着します。  
mōsugu tōchaku shimasu.  
I'll be there soon.

何時に始まりますか。  
nanji ni hajimarimasuka?  
What time does it start?

時間は、どのくらいかかりますか。  
jikan wa donokurai kakarimasuka?  
How long will it last?



# カレンダー karendā • calendar

月  
tsuki  
month

年  
toshi  
year

一月  
ichigatsu  
January

2010



曜日  
yōbi  
day

月曜日  
getsuyōbi  
Monday

火曜日  
kayōbi  
Tuesday

水曜日  
suiyōbi  
Wednesday

木曜日  
mokuyōbi  
Thursday

金曜日  
kin'yōbi  
Friday

土曜日  
doyōbi  
Saturday

日曜日  
nichiyōbi  
Sunday

週日  
shūjitsu  
work day

|    |    |    |    |    |    |    |
|----|----|----|----|----|----|----|
| 1  | 2  | 3  | 4  | 5  | 6  | 7  |
| 8  | 9  | 10 | 11 | 12 | 13 | 14 |
| 15 | 16 | 17 | 18 | 19 | 20 | 21 |

週  
shū  
week

日にち  
hinichi  
date

昨日  
kinō  
yesterday

今日  
kyō  
today

明日  
ashita  
tomorrow

週末  
shūmatsu  
weekend

## 関連用語 kanrenyōgo • vocabulary

一月  
ichigatsu  
January

三月  
sangatsu  
March

五月  
gogatsu  
May

七月  
shichigatsu  
July

九月  
kugatsu  
September

十一月  
jūichigatsu  
November

二月  
nigatsu  
February

四月  
shigatsu  
April

六月  
rokugatsu  
June

八月  
hachigatsu  
August

十月  
jūgatsu  
October

十二月  
jūnigatsu  
December

## 年 toshi • years

1900 一九〇〇年 sen kyūhyaku nen • nineteen hundred

1901 一九〇一年 sen kyūhyaku ichi nen • nineteen hundred and one

1910 一九一〇年 sen kyūhyaku jū nen • nineteen ten

2000 二〇〇〇年 nisen nen • two thousand

2001 二〇〇一年 nisen ichi nen • two thousand and one

## 季節 kisetsu • seasons

春  
haru  
spring夏  
natsu  
summer秋  
aki  
autumn冬  
fuyu  
winter

## 関連用語 kanrenyōgo • vocabulary

世紀  
seiki  
century今週  
konshū  
this week明後日  
asatte  
the day after tomorrow今日は何日ですか。  
kyō wa nannichi desuka?  
What's the date today?十年間  
jūnenkan  
decade先週  
senshū  
last week毎週  
maishū  
weekly2002年2月17日です。  
nisen ni nen nigatsu jūshichi nichi desu.  
It's February seventeenth, two  
thousand and two.千年間  
sennenkan  
millennium来週  
raishū  
next week毎月  
maitzuki  
monthly二週間  
nishūkan  
fortnight一昨日  
ototoi  
the day before yesterday毎年  
maitoshi  
annual

# 数字 sūji • numbers

|    |                                |     |                                  |
|----|--------------------------------|-----|----------------------------------|
| 0  | 零 rei • zero                   | 20  | 二十 nijū • twenty                 |
| 1  | 一 ichi • one                   | 21  | 二十一 nijūichi • twenty-one        |
| 2  | 二 ni • two                     | 22  | 二十二 nijūni • twenty-two          |
| 3  | 三 san • three                  | 30  | 三十 sanjū • thirty                |
| 4  | 四 shi/yon • four               | 40  | 四十 shijū/yonjū • forty           |
| 5  | 五 go • five                    | 50  | 五十 gojū • fifty                  |
| 6  | 六 roku • six                   | 60  | 六十 rokjū • sixty                 |
| 7  | 七 shichi/nana • seven          | 70  | 七十 shichijū/nanajū • seventy     |
| 8  | 八 hachi • eight                | 80  | 八十 hachijū • eighty              |
| 9  | 九 ku/kyū • nine                | 90  | 九十 kyūjū • ninety                |
| 10 | 十 jū • ten                     | 100 | 百 hyaku • one hundred            |
| 11 | 十一 jūichi • eleven             | 110 | 百十 hyakujū • one hundred and ten |
| 12 | 十二 jūni • twelve               | 200 | 二百 nihyaku • two hundred         |
| 13 | 十三 jūsan • thirteen            | 300 | 三百 sambyaku • three hundred      |
| 14 | 十四 jūshi/jūyon • fourteen      | 400 | 四百 yonhyaku • four hundred       |
| 15 | 十五 jūgo • fifteen              | 500 | 五百 gohyaku • five hundred        |
| 16 | 十六 jūroku • sixteen            | 600 | 六百 roppyaku • six hundred        |
| 17 | 十七 jūshichi/jūnana • seventeen | 700 | 七百 nanahyaku • seven hundred     |
| 18 | 十八 jūhachi • eighteen          | 800 | 八百 happyaku • eight hundred      |
| 19 | 十九 jūku/jūkyū • nineteen       | 900 | 九百 kyūhyaku • nine hundred       |



|               |   |
|---------------|---|
| 1,000         | 千 sen • one thousand  |
| 10,000        | 一万 ichiman • ten thousand                                     |
| 20,000        | 二万 niman • twenty thousand                                    |
| 50,000        | 五万 goman • fifty thousand                                     |
| 55,500        | 五万五千五百 goman gosen gohyaku • fifty-five thousand five hundred |
| 100,000       | 十万 jūman • one hundred thousand                               |
| 1,000,000     | 百万 hyakuman • one million                                     |
| 1,000,000,000 | 十億 jūoku • one billion  |

一番目  
ichi banme  
first

二番目  
ni banme  
second

三番目  
san banme  
third



四番目 yon banme • fourth

五番目 go banme • fifth

六番目 roku banme • sixth

七番目 nana banme • seventh

八番目 hachi banme • eighth

九番目 kyū banme • ninth

十番目 jū banme • tenth

十一番目 jūichi banme • eleventh

十二番目 jūni banme • twelfth

十三番目 jūsan banme • thirteenth

十四番目 jūyon banme • fourteenth

十五番目 jūgo banme • fifteenth

十六番目 jūroku banme • sixteenth

十七番目 jūnana banme • seventeenth

十八番目 jūhachi banme • eighteenth

十九番目 jūkyū banme • nineteenth

二十番目 nijū banme • twentieth

二十一番目 nijūichi banme • twenty-first

二十二番目 nijūni banme • twenty-second

二十三番目 nijūsan banme • twenty-third

三十番目 sanjū banme • thirtieth

四十番目 yonjū banme • fortieth

五十番目 gojū banme • fiftieth

六十番目 rokjū banme • sixtieth

七十番目 nanajū banme • seventieth

八十番目 hachijū banme • eightieth

九十番目 kyūjū banme • ninetieth

百番目 hyaku banme • one hundredth

# 計量 keiryō • weights and measures

## 面積 menseki • area

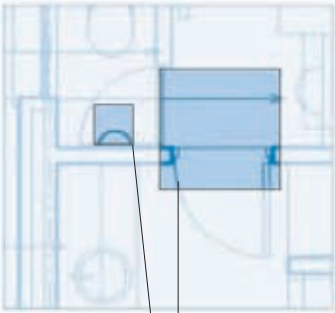

平方フィート  
heihō fito  
square foot

平方メートル  
heihō mētoru  
square meter

## 距離 kyori • distance



キロメートル  
kiromētoru  
kilometer

マイル  
mairu  
mile

## 長さ nagasa • length

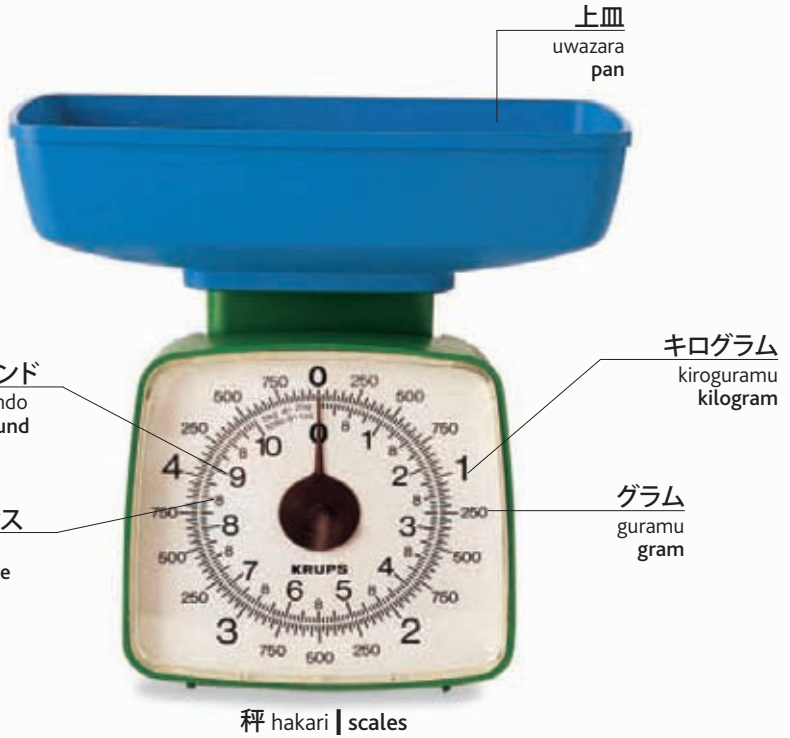
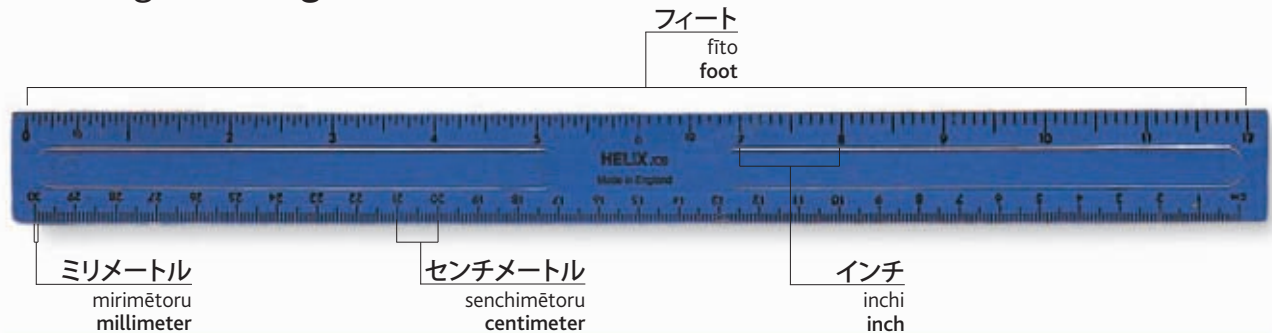

## 関連用語 kanrenyōgo • vocabulary

ヤード  
yādo  
yard

トン  
ton  
ton

測る  
hakaru  
measure (v)

メートル  
mētoru  
meter

ミリグラム  
miriguramu  
milligram

量る  
hakaru  
weigh (v)

## 容量 yōryō • capacity

0.5リットル  
rei ten go rittoru  
half-liter

パイント  
painto  
pint

容積  
yōseki  
volume

ミリリットル  
miririttoru  
milliliter



計量カップ keiryō kappu | measuring cup



液体計量器 ekitai keiryōki  
liquid measure

関連用語  
kanrenyōgo •  
vocabulary

ガロン  
garan  
gallon

クオート  
kuōto  
quart

リットル  
ritturu  
liter

## 容器 yōki • container



紙パック  
kami pakku  
carton



包み  
tsutsumi  
package



瓶  
bin  
bottle



袋  
fukuro  
bag



カップ形容器  
kappu-gata yōki | tub



広口瓶 hirokuchi bin | jar



缶  
kan  
can

缶詰容器 kanzume yōki | tin



霧吹き kirifuki | liquid dispenser

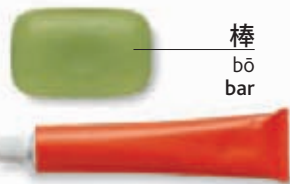

棒  
bō  
bar

チューブ  
chūbu  
tube



ロール  
rōru  
roll



パック  
pakku  
pack



スプレー缶  
supurē kan  
spray can



# 世界地図 sekai chizu • world map

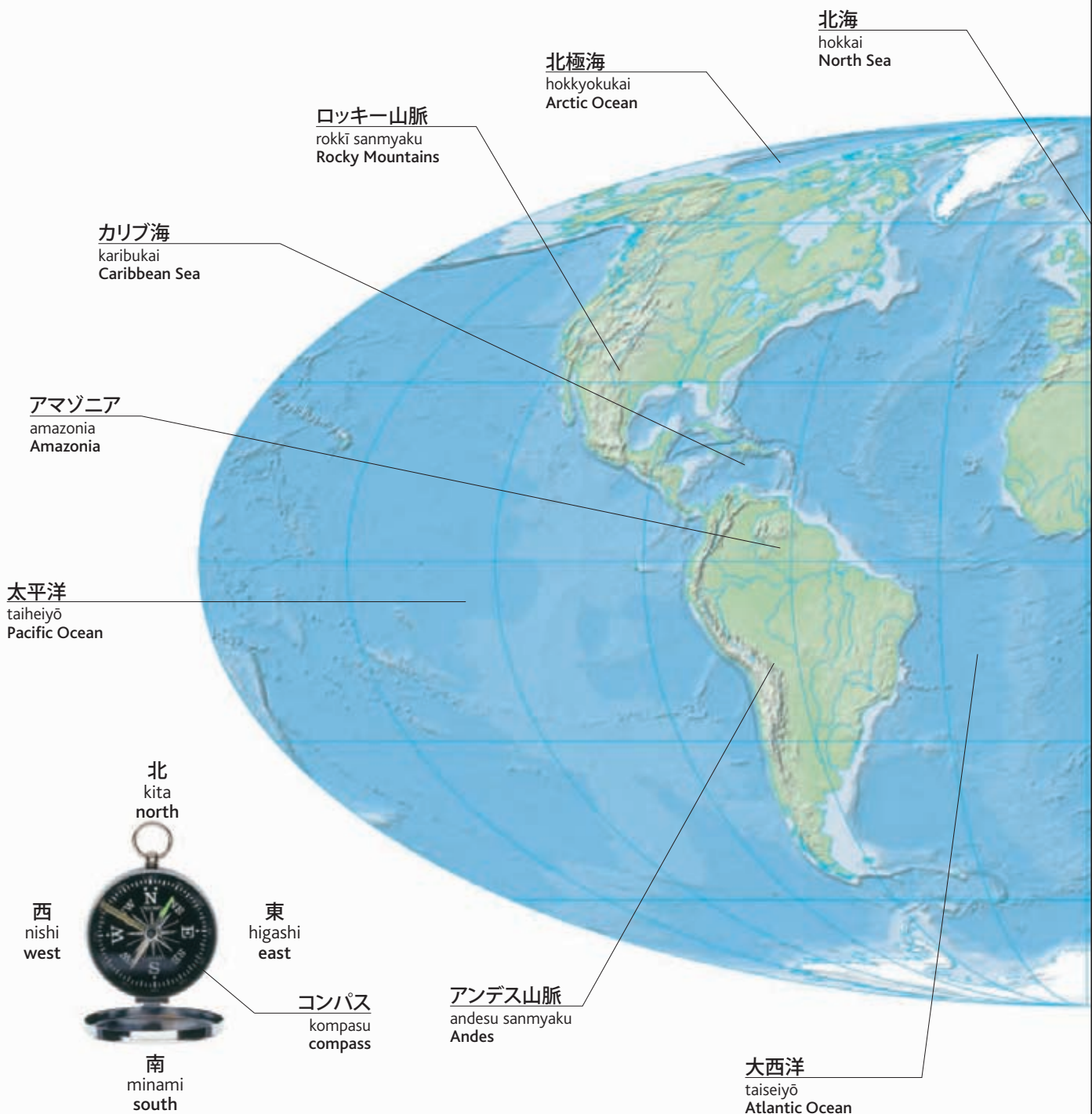



# 北米と中米 hokubei to chūbei • North and Central America



- 1 アラスカ arasuka • Alaska
- 2 カナダ kanada • Canada
- 3 グリーンランド gurīnrando • Greenland
- 4 アメリカ合衆国 amerika gasshūkoku • United States of America
- 5 メキシコ mekishiko • Mexico
- 6 グアテマラ guatemala • Guatemala
- 7 ベリーズ berīzu • Belize
- 8 エルサルバドル erusarubadoru • El Salvador
- 9 ホンジュラス honjurasu • Honduras
- 10 ニカラグア nikaragua • Nicaragua
- 11 コスタリカ kosutarika • Costa Rica
- 12 パナマ panama • Panama
- 13 キューバ kyūba • Cuba
- 14 バハマ bahama • Bahamas
- 15 ジャマイカ jamaika • Jamaica
- 16 ハイチ haichi • Haiti
- 17 ドミニカ共和国 dominika kyōwakoku • Dominican Republic
- 18 プエルトリコ puerutoriko • Puerto Rico
- 19 バルバドス barubadosu • Barbados
- 20 トリニダード・トバゴ torinidādo tobago • Trinidad and Tobago
- 21 セントクリストファー・ネーヴィス sentokurisutofā nēvisu • St. Kitts and Nevis

- 22 アンティグア・バーブーダ antigua bābūda • Antigua and Barbuda
- 23 ドミニカ dominika • Dominica
- 24 セントルシア sentorushia • St. Lucia
- 24 セントビンセント及びグレナディーン諸島 sentobinsento oyobi gurenadin shotō • St. Vincent and The Grenadines
- 26 グレナダ gurenada • Grenada



## 南米 nambei • South America



- 1 ベネズエラ benezuera • Venezuela
- 2 コロンビア korombia • Colombia
- 3 エクアドル ekuadoru • Ecuador
- 4 ペルー perū • Peru
- 5 ガラパゴス諸島 garapagosu shotō • Galapagos Islands
- 6 ギアナ giana • Guyana
- 7 スリナム surinamu • Suriname
- 8 仏領ギアナ futsuryō giana • French Guiana
- 9 ブラジル burajiru • Brazil
- 10 ボリビア boribia • Bolivia
- 11 チリ chiri • Chile
- 12 アルゼンチン aruzenchin • Argentina
- 13 パラグアイ paraguai • Paraguay
- 14 ウルグアイ uruguai • Uruguay
- 15 フォークランド諸島 fōkurando shotō • Falkland Islands

**関連用語 kanrenyōgo • vocabulary**

|                            |                              |                         |
|----------------------------|------------------------------|-------------------------|
| 国<br>kuni<br>country       | 地方<br>chihō<br>province      | 地帯<br>chitai<br>zone    |
| 国家<br>kokka<br>nation      | 領土<br>ryōdo<br>territory     | 地区<br>chiku<br>district |
| 大陸<br>tairiku<br>continent | 植民地<br>shokuminchi<br>colony | 地域<br>chi'iki<br>region |
| 州<br>shū<br>state          | 公国<br>kōkoku<br>principality | 首都<br>shuto<br>capital  |

## ヨーロッパ yōroppa • Europe

- |  |   |  |
|--|---|--|
| 1 アイルランド airurando • Ireland                 | 30 バチカン市国 bachikan shikoku • Vatican City | 41 セルビア serubia • Serbia                                       |
| 2 英国 eikoku • United Kingdom                 | 31 シチリア shichiria • Sicily                | 42 ボスニア・ヘルツェゴビナ bosunia herutsegobina • Bosnia and Herzegovina |
| 3 ポルトガル porutogaru • Portugal                | 32 マルタ maruta • Malta                     | 43 アルバニア arubania • Albania                                    |
| 4 スペイン supein • Spain                        | 33 スロベニア surobenia • Slovenia             | 44 マケドニア makedonia • Macedonia                                 |
| 5 バレアレス諸島 barearesu shotō • Balearic Islands | 34 クロアチア kuroachia • Croatia              | 45 ブルガリア burugaria • Bulgaria                                  |
| 6 アンドラ andora • Andorra                      | 35 ハンガリー hangarī • Hungary                | 46 ギリシャ girisha • Greece                                       |
| 7 フランス furansu • France                      | 36 スロバキア surobakia • Slovakia             | 47 コソボ kosobo • Kosovo   |
| 8 ベルギー berugī • Belgium                      | 37 ウクライナ ukuraina • Ukraine               | 48 モンテネグロ monteneguro • Montenegro                             |
| 9 オランダ oranda • Netherlands                  | 38 ベラルーシ berarūshi • Belarus              |  |
| 10 ルクセンブルク rukusemburuku • Luxembourg        | 39 モルドバ morudoba • Moldova                |  |
| 11 ドイツ doitsu • Germany                      | 40 ルーマニア rūmania • Romania                |  |
| 12 デンマーク denmāku • Denmark                   |   |  |
| 13 ノルウェー noruwē • Norway                     |   |  |
| 14 スウェーデン suwēden • Sweden                   |   |  |
| 15 フィンランド finrando • Finland                 |   |  |
| 16 エストニア esutonia • Estonia                  |   |  |
| 17 ラトビア ratobia • Latvia                     |   |  |
| 18 リトアニア ritoania • Lithuania                |   |  |
| 19 カリーニングラード karīningurādo • Kaliningrad     |   |  |
| 20 ポーランド pōrando • Poland                    |   |  |
| 21 チェコ共和国 cheko kyōwakoku • Czech Republic   |   |  |
| 22 オーストリア ōsutoria • Austria                 |   |  |
| 23 リヒテンシュタイン rihitenshutain • Liechtenstein  |   |  |
| 24 スイス suisu • Switzerland                   |   |  |
| 25 イタリア itaria • Italy                       |   |  |
| 26 モナコ monako • Monaco                       |   |  |
| 27 コルシカ korushika • Corsica                  |   |  |
| 28 サルディニア sarudinia • Sardinia               |   |  |
| 29 サンマリノ sanmarino • San Marino              |   |  |



## アフリカ afurika • Africa



- 1 モロッコ morokko • Morocco
- 2 西サハラ nishi sahara • Western Sahara
- 3 モーリタニア mōritania • Mauritania
- 4 セネガル senegaruru • Senegal
- 5 ガンビア gambia • Gambia
- 6 ギニアビサウ giniabisau • Guinea-Bissau
- 7 ギニア ginia • Guinea
- 8 シエラレオネ shierareone • Sierra Leone
- 9 リベリア riberia • Liberia
- 10 コートジボワール kōtojobowāru • Ivory Coast
- 11 ブルキナファソ burukinafaso • Burkina Faso
- 12 マリ mari • Mali
- 13 アルジェリア arujeria • Algeria
- 14 チュニジア chunijia • Tunisia
- 15 リビア ribia • Libya
- 16 ニジェール nijēru • Niger
- 17 ガーナ gāna • Ghana
- 18 トーゴ tōgo • Togo

- 19 ベニン benin • Benin
- 20 ナイジェリア naijeria • Nigeria
- 21 サントメ・プリンシペ santome purinshipe • Sao Tome and Principe
- 22 赤道ギニア sekidō ginia • Equatorial Guinea
- 23 カメルーン kamerūn • Cameroon
- 24 チャド chado • Chad
- 25 エジプト ejiputo • Egypt
- 26 スーダン sūdān • Sudan
- 27 エリトリア eritoria • Eritrea
- 28 ジブチ jipuchi • Djibouti
- 29 エチオピア echiopia • Ethiopia
- 30 ソマリア somaria • Somalia

- 31 ケニア kenia • Kenya
- 32 ウガンダ uganda • Uganda
- 33 中央アフリカ共和国 chūō afurika kyōwakoku • Central African Republic
- 34 ガボン gabon • Gabon
- 35 コンゴ kongo • Congo
- 36 カビンダ kabinda • Cabinda
- 37 コンゴ民主共和国 kongo minshu kyōwakoku • Democratic Republic of the Congo
- 38 ルワンダ ruwanda • Rwanda
- 39 ブルンジ burunji • Burundi
- 40 モザンビーク mizambiku • Mozambique
- 41 タンザニア tanzania • Tanzania
- 42 マラウイ marawi • Malawi
- 43 ザンビア zambia • Zambia
- 44 アンゴラ angora • Angola
- 45 ナミビア namibia • Namibia
- 46 ボツワナ botsuwana • Botswana
- 47 ジンバブエ jimbabue • Zimbabwe
- 48 南アフリカ minami afurika • South Africa
- 49 レソト resoto • Lesotho
- 50 スワジランド suwajirando • Swaziland
- 51 コモロ komoro • Comoros
- 52 マダガスカル madagasukaru • Madagascar
- 53 モーリシャス mōrishasu • Mauritius



# アジア ajia • Asia

- 1 トルコ toruko • Turkey
- 2 キプロス kipurosu • Cyprus
- 3 ロシア連邦 roshia rempō • Russian Federation
- 4 グルジア gurujia • Georgia
- 5 アルメニア arumenia • Armenia
- 6 アゼルバイジャン azerubaijan • Azerbaijan
- 7 イラン iran • Iran
- 8 イラク iraku • Iraq
- 9 シリア shiria • Syria
- 10 レバノン rebanon • Lebanon
- 11 イスラエル isuraeru • Israel
- 12 ヨルダン yorudan • Jordan
- 13 サウジアラビア saujiarabia • Saudi Arabia
- 14 クウェート kuwēto • Kuwait
- 15 バーレーン bārēn • Bahrain
- 16 カタール katāru • Qatar
- 17 アラブ首長国連邦 arabu shuchō-koku rempō • United Arab Emirates
- 18 オマーン omān • Oman
- 19 イエメン iemen • Yemen
- 20 カザフスタン kazafusutan • Kazakhstan
- 21 ウズベキスタン uzubekisutan • Uzbekistan
- 22 トルクメニスタン torukumenisutan • Turkmenistan
- 23 アフガニスタン afuganisutan • Afghanistan
- 24 タジキスタン tajikisutan • Tajikistan
- 25 キリギスタン kirigisutan • Kyrgyzstan
- 26 パキスタン pakisutan • Pakistan
- 27 インド indo • India
- 28 モルディブ morudibu • Maldives
- 29 スリランカ suriranka • Sri Lanka
- 30 中国 chūgoku • China
- 31 モンゴル mongoru • Mongolia
- 32 北朝鮮 kita chōsen • North Korea
- 33 韓国 kankoku • South Korea
- 34 日本 nihon • Japan
- 35 ネパール nepāru • Nepal



- 36 ブータン būtan • Bhutan
- 37 バングラデシュ banguradeshu • Bangladesh
- 38 ビルマ(ミャンマー) biruma (myanmā) • Myanmar
- 39 タイ tai • Thailand
- 40 ラオス raosu • Laos
- 41 ベトナム betonamu • Viet Nam
- 42 カンボジア kambojia • Cambodia

オーストラレーシア  
ōsutorarēshia • Australasia



- 1 オーストラリア ōsutoraria • Australia
- 2 タスマニア tasumania • Tasmania
- 3 ニュージーランド nyūjīrando • New Zealand

- 43 マレーシア marēshia • Malaysia
- 44 シンガポール shingapōru • Singapore
- 45 インドネシア indoneshia • Indonesia
- 46 ブルネイ burunei • Brunei
- 47 フィリピン firipin • Philippines
- 48 東ティモール higashi timōru • East Timor
- 49 パプアニューギニア papuanyūginia • Papua New Guinea
- 50 ソロモン諸島 soromon shotō • Solomon Islands
- 51 バヌアツ banuatsu • Vanuatu
- 52 フィジー fiji • Fiji



# 不変化詞と反義語 fuhenkashi to hangigo • particles and antonyms

...へ  
... e  
to ...

...の上方  
... no jōhō  
over ...

...の前  
... no mae  
in front of ...

...の上へ  
... no ue e  
onto ...

中  
naka  
in

真上  
maue  
above

内側  
uchigawa  
inside

上へ  
ue e  
up

...で  
... de  
at ...

...を通過して  
... o tōtte  
through ...

...の上  
... no ue  
on top of ...

...の間  
... no aida  
between ...

近い  
chikai  
near

ここ  
koko  
here

...から  
... kara  
from ...

...の下方  
... no kahō  
under ...

...の後ろ  
... no ushiro  
behind ...

...の中へ  
... no naka e  
into ...

外  
soto  
out

真下  
mashita  
below

外側  
sotogawa  
outside

下へ  
shita e  
down

...の向こう  
... no mukō  
beyond ...

...を回って  
... o mawatte  
around ...

...の側  
... no soba  
beside ...

...の向かい側  
... no mukaigawa  
opposite ...

遠い  
tōi  
far

あそこ  
asoko  
there

...から離れて  
... kara hanarete  
away from...

...に沿って  
... ni sotto  
along ...

...と一緒に  
... to issho ni  
with ...

...以前  
... izen  
before ...

...までに  
... made ni  
by ...

早い  
hayai  
early

今  
ima  
now

いつも  
itsumo  
always

頻繁に  
himpan ni  
often

昨日  
kinō  
yesterday

最初  
saisho  
first

あらゆる  
arayuru  
every

およそ  
oyoso  
about

少し  
sukoshi  
a little

...に向かって  
... ni mukatte  
toward ...

...を横切って  
... o yokogitte  
across ...

...なしで  
... nashi de  
without ...

...以後  
... igo  
after ...

...まで  
... made  
until ...

遅い  
osoi  
late

後ほど  
nochihodo  
later

決して...ない  
kesshite ... nai  
never

稀に  
mare ni  
rarely

明日  
ashita  
tomorrow

最後  
saigo  
last

いくつかの  
ikutsuka no  
some

丁度  
chōdo  
exactly

沢山  
takusan  
a lot



|                               |                                 |                                 |                               |
|-------------------------------|---------------------------------|---------------------------------|-------------------------------|
| 大きい<br>ōki<br>large           | 小さい<br>chīsai<br>small          | 熱い<br>atsui<br>hot              | 冷たい<br>tsumetai<br>cold       |
| 幅の広い<br>haba no hiroi<br>wide | 幅の狭い<br>haba no semai<br>narrow | 開いた<br>hiraita<br>open          | 閉まった<br>shimatta<br>closed    |
| 背の高い<br>se no takai<br>tall   | 背の低い<br>se no hikui<br>short    | 満ちた<br>michita<br>full          | 空の<br>kara no<br>empty        |
| 高い<br>takai<br>high           | 低い<br>hikui<br>low              | 新しい<br>atarashī<br>new          | 古い<br>furui<br>old            |
| 厚い<br>atsui<br>thick          | 薄い<br>usui<br>thin              | 明るい<br>akarui<br>bright         | 暗い<br>kurai<br>dark           |
| 軽い<br>karui<br>light          | 重い<br>omoi<br>heavy             | 簡単な<br>kantan na<br>easy        | 難しい<br>muzukashī<br>difficult |
| 硬い<br>katai<br>hard           | 柔らかい<br>yawarakai<br>soft       | 空き<br>aki<br>free               | 使用中<br>shiyō-chū<br>occupied  |
| 湿った<br>shimetta<br>wet        | 乾いた<br>kawaita<br>dry           | 強い<br>tsuyoi<br>strong          | 弱い<br>yowai<br>weak           |
| 良い<br>yoi<br>good             | 悪い<br>warui<br>bad              | 太い<br>futoi<br>fat              | 細い<br>hosoi<br>thin           |
| 速い<br>hayai<br>fast           | ゆっくりした<br>yukkurishita<br>slow  | 若い<br>wakai<br>young            | 老いた<br>oita<br>old            |
| 正しい<br>tadashī<br>correct     | 誤った<br>ayamatta<br>wrong        | より良い<br>yori yoi<br>better      | もっと悪い<br>motto warui<br>worse |
| きれいな<br>kirei na<br>clean     | 汚い<br>kitanai<br>dirty          | 黒<br>kuro<br>black              | 白<br>shiro<br>white           |
| 美しい<br>utsukushī<br>beautiful | 醜い<br>minikui<br>ugly           | 面白い<br>omoshiroi<br>interesting | つまらない<br>tsumaranai<br>boring |
| 高価な<br>kōka na<br>expensive   | 安い<br>yasui<br>cheap            | 病気の<br>byōki no<br>sick         | 健康な<br>kenkō na<br>well       |
| 静かな<br>shizuka na<br>quiet    | うるさい<br>urusai<br>noisy         | 始め<br>hajime<br>beginning       | 終わり<br>owari<br>end           |

# 便利な表現 benri na hyōgen • useful phrases

基本的表現  
kihonteki hyōgen  
• essential phrases

はい  
hai  
Yes

いいえ  
īe  
No

多分  
tabun  
Maybe

どうぞ  
dōzo  
Please

ありがとう  
arigatō  
Thank you

どういたしまして  
dō itashimashite  
You're welcome

すみません  
sumimasen  
Excuse me

ごめんなさい  
gomen nasai  
I'm sorry

...しないでください  
... shinaide kudasai  
Don't ...

オーケー  
ōkē  
OK

それで結構です  
sorede kekkō desu  
That's fine

そうです  
sōdesu  
That's correct

違います  
chigaimasu  
That's wrong

挨拶 aisatsu •  
greetings

もしもし  
moshimoshi  
Hello (*on telephone*)

さようなら  
sayōnara  
Goodbye

おはようございます  
ohayō gozaimasu  
Good morning

こんにちは  
konnichiwa  
Good afternoon

こんばんは  
kombanwa  
Good evening

おやすみなさい  
oyasuminasai  
Good night

お元気ですか  
o-genki desuka  
How are you?

私は...です  
watashi wa ... desu  
My name is...

お名前は何ですか  
o-namae wa nan desuka?  
What is your name?

彼/彼女のお名前は  
kare/kanojo no o-namae wa?  
What is his/her name?

...をご紹介します  
... o go-shōkai shimasu  
May I introduce...

こちらは...です  
kochira wa ... desu  
This is...

初めまして  
hajimemashite  
Pleased to meet you

また後で  
mata ato de  
See you later

標識 hyōshiki • signs

観光案内所  
kankō annai-jo  
Tourist information

入口  
iriguchi  
Entrance

出口  
deguchi  
Exit

非常口  
hijōguchi  
Emergency exit

押す  
osu  
Push

危険  
kiken  
Danger

禁煙  
kin'en  
No smoking

故障中  
koshōchū  
Out of order

開館時間  
kaikan jikan  
Opening times

入場無料  
nyūjō muryō  
Free admission

全日営業  
zennichi eigyō  
Open all day

割引料金  
waribiki ryōkin  
Reduced price

特売  
tokubai  
Sale

ノックしてください  
nokku shite kudasai  
Knock before entering

芝生立ち入り禁止  
shibafu tachi'iri kinshi  
Keep off the grass

援助 enjo • help

助けてください  
tasukete kudasai  
Please help me

分かりません  
wakarimasen  
I don't understand

知りません  
shirimasen  
I don't know

英語/日本語を話せますか  
eigo/nihongo o  
hanasemasuka?  
Do you speak English/  
Japanese?

英語を話せませ  
eigo hanasemasu  
I speak English

スペイン語を話せませ  
suepingo o hanasemasu  
I speak Spanish

もっとゆっくり言ってくだ  
さい  
motto yukkuri itte kudasai  
Please speak more slowly

書いてください  
kaite kudasai  
Please write it down for me

...をなくしました  
... o nakushimashita  
I have lost...

道案内 michi annai •  
directions

道に迷いました  
michi ni mayoimashita  
I am lost

...はどこですか  
... wa doko desuka?  
Where is the...?

最寄りの...はどこですか  
moyori no ... wa doko  
desuka?  
Where is the nearest...?

お手洗いはどこですか  
o-tearai wa doko desuka?  
Where are the toilets?

右です  
migi desu  
To the right

左です  
hidari desu  
To the left

まっすぐです  
massugu desu  
Straight ahead

...は、どのくらい離れてい  
ますか  
... wa donokurai hanarete  
imasuka  
How far is...?

...への行き方を教えてく  
ださい  
... e no ikikata o oshiete  
kudasai  
How do I get to...?

道路標識 dōro hyōshiki  
• road signs

注意  
chūi  
Caution

進入禁止  
shinnyū kinshi  
No entry

スピード落せ  
supīdo otose  
Slow down

迂回路  
ukairo  
Diversion

右側通行  
migigawa tsūkō  
Keep to the right

高速道路  
kōsokudōro  
Motorway

駐車禁止  
chūsha kinshi  
No parking

通行禁止  
tsūkō kinshi  
No through road

道路工事中  
dōro kōji-chū  
Roadworks

一方通行  
ippōtsūkō  
One-way street

譲れ  
yuzure  
Give way

止まれ  
tomare  
Stop

屈折あり  
kussetsu ari  
Dangerous bend

宿泊 shukuhaku •  
accomodation

予約してあります  
yoyaku shite arimasu  
I have a reservation

朝食は何時ですか  
chōshoku wa nanji  
desuka  
What time is breakfast?

食堂はどこですか  
shokudō wa doko desuka?  
Where is the dining room?

私の部屋は...号室です  
watashi no heya wa  
...-gōshitsu desu  
My room number is...

...時に戻ります  
... ji ni modorimasu  
I'll be back at...o'clock

飲食 inshoku •  
eating and drinking

乾杯!  
kampai  
Cheers!

美味しい/不味いです  
oishi/mazui desu  
It's delicious/awful

お酒は飲みません  
o-sake wa nomemasen  
I don't drink

煙草は吸いません  
tabako wa suimasen  
I don't smoke

肉は食べません  
niku wa tabemasen  
I don't eat meat

もう結構です  
mō kekkō desu  
No more for me, thank you

もう少し、いただけますか  
mō sukoshi itadakemasuka?  
May I have some more?

会計をお願いします  
kaiei o onegaishimasu  
Please give us the bill

領収書をください  
ryōshūsho o kudasai  
Please give us a receipt

禁煙席  
kin'en seki  
No-smoking area

健康 kenkō •  
health

体調が優れません  
taichō ga suguremasen  
I don't feel well

気分が悪いです  
kibun ga warui desu  
I feel sick

最寄りの医者電話番号  
は何ですか  
moyori no isha no  
denwabangō wa nan desuka?  
What is the telephone  
number of the nearest  
doctor?

ここが痛いです  
koko ga itai desu  
It hurts here

熱があります  
netsu ga arimasu  
I have a temperature

妊娠...ヶ月です  
ninshin ...-kagetsu desu  
I'm...months pregnant

...の処方箋をください  
... no shohōsen o kudasai  
I need a prescription for...

普段は...を飲みます  
fudan wa ... o nomimasu  
I normally take ...

...にアレルギーがあります  
... ni arerugi ga arimasu  
I'm allergic to ...

大丈夫ですか  
daijōbu desuka?  
Will he/she be all right?



## 日本語索引 | nihongo sakuin • Japanese index

## A

abaraniku 119  
 abokado 128  
 abumi 242  
 abura 142  
 abura enogu 274  
 abura hada 41  
 abura shitsu 39  
 abura-zuke 143  
 aburami 119  
 abuzairen 248  
 āchi 85, 301  
 āchi-gata yane 300  
 adobantēji 230  
 aen 289  
 aen mekki 79  
 afuganisutan 318  
 afurika 317  
 afutāsankea 108  
 afutāshēbu 73  
 ageru 67  
 ageta 159  
 ago 14  
 agurifurūtsu 126  
 ahiru no tamago 137  
 ai yū dī 21  
 ai'iro 274  
 aian 233  
 aiburow- burashi 40  
 aiburow-penshiru 10  
 aikappu 269  
 aikidō 236  
 aikon 177  
 airainā 40  
 airon 76  
 airon o kakeru 76  
 airondai 76  
 airurando 316  
 aisatsu 322  
 aishadō 40  
 aishingu 141  
 aisu baketsu 150  
 aisu hokkē 224  
 aisu kōhī 148  
 aisu kuraimingu 147  
 aisu sukēto 247  
 aisu tī 149  
 aisu hokkē senshu 224  
 aisu hokkē-yō rinku 224  
 aisu kurūrimu 137, 149  
 aisu kurūrimu sukūpu 68  
 aite 236  
 ajia 318  
 aka 274  
 aka (wain) 145  
 aka chikori 123  
 aka rentiru 131  
 aka tōgarashi 124  
 akachairo 39  
 akachan 30  
 akachan-yō taijūkei 53  
 akage 39

akame 271  
 akami niku 118  
 akarui 321  
 akashia 110  
 aki 31, 307, 321  
 akiresuken 16  
 akiru 25  
 ākitorēbu 301  
 akuamarin 288  
 akubi suru 25  
 akuriru enogu 274  
 akuseru 200  
 akusesari 36  
 akusuru 205  
 ama 184  
 amadoi 58  
 amagu 245, 267  
 amai 124, 127, 155  
 amakawa 15  
 amazonia 312  
 amba 235  
 ame 287  
 ame-gachi na 286  
 amefuto shūzu 220  
 amejisuto 288  
 amerika gasshūkoku 314  
 amerikan futtobōru 220  
 ameya 113  
 ami 217  
 amiagegutsu 37  
 amibari 277  
 amidana 209  
 amimono 277  
 amiuchi suru 245  
 āmondo 129, 151  
 āmondo oiru 134  
 ampaia 225  
 ampea 60  
 ampu 268  
 āmu kāru 251  
 āmu resuto 200  
 āmubando 238  
 āmuchoe 63  
 ana 244  
 ana o akeru 79  
 ana'ake panchi 173  
 ana'aki supūn 68  
 andā pā 233  
 andesu sanmyaku 312  
 andora 316  
 angora 317  
 anime 178  
 anime eiga 255  
 ankō 120  
 ankōru 255  
 annai 261  
 annai zu 261  
 annai-ban 213  
 annai-gakari 255  
 anorakku 31, 33  
 anshitsu 271  
 anshō bangō 96

antigua bābūda 314  
 anzempin 47  
 anzen gōguru 167  
 anzen saku 246  
 anzen yōgu 240  
 anzen yōhin 75  
 anzu 126  
 ao 274  
 aoi 129  
 apurikēshon 176  
 arabiakai 313  
 arabiki mugī 130  
 arabu shuchō-koku rempō 318  
 arakaruto 152  
 araseitō 110  
 arashi 287  
 arasuka 314  
 arau 38, 77  
 arayuru 320  
 arenjimento 111  
 arerugi 44  
 ari 295  
 arigatō 322  
 arigētā 293  
 arīna 243  
 aromaterapī 55  
 āru deko 301  
 āru nūbō 301  
 arubamu 271  
 arubania 316  
 arurarufa 184  
 arujeria 317  
 arukōru inryō 145  
 arumenia 318  
 aruminiumu 289  
 arupen sukī 247  
 aruzenchin 315  
 asa 305  
 asari 121  
 asase 239  
 asatsuki 133  
 asatte 307  
 ashi 12, 13, 15, 64, 119  
 ashi no kō 15  
 ashi no kō no uchigawa 15  
 ashi no koyubi 15  
 ashi no oyayubi 15  
 ashi no tsume 15  
 ashiba 186  
 ashika 290  
 ashikubi 13, 15  
 ashisutanto 24  
 ashita 306, 320  
 ashiura 15  
 ashiyubi 15  
 asobi 75  
 asobiba 263  
 asobu 273  
 asoko 320  
 atakkingu zōn 224  
 atama 12, 19, 80  
 atarashī 130, 321

atataakai 286  
 atataakai nomimono 144  
 atatamenaosu 154  
 ātichōku 124  
 atopisei hifuen 44  
 atoriumu 104  
 atsu-giri 121  
 atsugami 275  
 atsui 286, 321  
 atsuryoku barubu 61  
 auto 225, 228  
 auto obu baunzu 226  
 autorigā 187  
 awa 148  
 awadateki 68  
 awadateru 67  
 awaseru 179  
 ayamatta 321  
 ayame 110  
 ayuruvēda 55  
 aza 46  
 azami 297  
 azarashi 290  
 aze 183  
 azerbaijan 318  
 azuki 131

## B

bā 150, 235, 250  
 bā sutsūru 150  
 baba bajutsu 243  
 bābekyū 267  
 bāberu 251  
 baburu basu 73  
 bachikan shikoku 316  
 badominton 231  
 bāgā miru 154  
 bagetto 138  
 baggu 37  
 bahama 314  
 baiauron 247  
 baiku uea 205  
 baiorin 256  
 baishin'in 180  
 baishin'in seki 180  
 baito 176  
 baizā 205  
 bajiriko 133  
 bajji 94  
 baketsu 77, 82, 265  
 bakku 223  
 bakku mirā 198  
 bakku suru 195  
 bakkubōdo 226  
 bakkugyamon 272  
 bakkuhando 231  
 bakkuru 36  
 bakkusuingu 233  
 bākōdo 106  
 bākōdo yomitori sōchi 106  
 bakuga inryō 144  
 bakugekiki 211

bampā 198  
 ban 305  
 banana 128  
 bandoēdo 47  
 banebakari 166  
 bangō annai 99  
 bangumi 269  
 bangumi seisaku 178  
 banguradeshu 318  
 banira 132  
 banji jampu 248  
 banjō gēmu 272  
 bankā 232  
 bansōkō 47  
 banuatsu 319  
 banzu 155  
 bappu 139  
 bara 89, 110  
 barē 255  
 barearesu shotō 316  
 barēbōru 227  
 barokku 301  
 baroku 242  
 barubadosu 314  
 barubu 207  
 barukoni seki 254  
 barumitsubā 26  
 barusamiko su 135  
 barutokai 313  
 basha rēsu 243  
 bashsi 50  
 basu 196  
 basu kurarinetto 257  
 basu machiai-jo 197  
 basu matto 72  
 basu no untenshu 190  
 basu tāminaru 197  
 basu taoru 73  
 basu-tei 197  
 basuketto 95, 226, 263  
 basukettobōru 226  
 basukettobōru senshu 226  
 basuku 35  
 basurōbu 73  
 basutei 299  
 batā 137, 156  
 batafurai 239  
 batāmīruku 137  
 batānatto sukuwasshu 125  
 bāten 150, 191  
 baton 235  
 battā 228  
 batterī 202  
 batto 225, 228  
 battsuman 225  
 baundari 225  
 baundo suru 227  
 bayonetto-shiki 60  
 bebi basu 74  
 bebi gēto 75  
 bebi kea 74  
 bebi monitā 75

- bebī rūmu 104  
 bebī suringu 75  
 bebī yōhin 107  
 bebī-yō magu kappu 75  
 bebībēdo 74  
 bebīgurō 30  
 bebīkā 75  
 bebīsākuru 75  
 beddo 70, 71  
 beddo bampā 74  
 beddo sukāto 71  
 beddokabā 70  
 beddomēkingu suru 71  
 beddosaido rampu 70  
 beddosaido tēburu 70  
 bēguru 139  
 beji bāgā 155  
 bēkingu torei 69  
 bēkon 118, 157  
 benchi 250, 262  
 beneshan buraindo 63  
 benezuera 315  
 bengoshi 180, 190  
 benin 317  
 benki 61, 72  
 bentō 154  
 benza 61, 72  
 beranda 59  
 berarūshi 316  
 berīzu 314  
 bero 37  
 beru 197  
 bēru 35  
 berugi 316  
 beruto 32, 36  
 beruto kombea 106  
 bēshisuto 258  
 bēsu 99  
 bēsu gitā 258  
 bēsuirain 230  
 besuto 33, 35  
 betonamu 318  
 biburafon 257  
 bīchi baggu 264  
 bīchi bōru 265  
 bīchi parasoru 264  
 bīchi taoru 265  
 bide 72  
 bideo denwa 99  
 bideo rekōdā 269  
 bideo tēpu 269  
 bihin 38  
 bijimesu'ūman 175  
 bijinesu 175  
 bijinesu kurasu 211  
 bijinesu pātonā 24  
 bijinesu ranchi 175  
 bijinesuman 175  
 bijutsu 162  
 bijutsu daigaku 169  
 bijutsu to kōgei 274  
 bijutsukan 261  
 bijutsushi 169  
 bīkā 167  
 bikini 264  
 bikotsu 17  
 biku 245  
 bin 134, 135, 311  
 biniru tai 89  
 bankan hada 41  
 binmei 212  
 binzume furūtsu 135  
 binzume shokuhin 134  
 biora 256  
 bīru 145, 151  
 biruma (myanmā) 318  
 bishin 283  
 bishō 25  
 bishoppu 272  
 bisuketto 141  
 bitā 145  
 bitamin-zai 108  
 bito 259  
 bitōrūto 125  
 biyō 40  
 biyōin 115  
 biyoku 210  
 biyōshi 188  
 biza 213  
 bō 311  
 bō-tsuki kyandī 113  
 bōrā 225  
 bobin 276  
 bobu 39  
 bobusurē 247  
 bodi rōshon 73  
 bōdo 241  
 bōfū fensu 265  
 bōfuzai 83  
 bōgyo 220  
 bōhan beru 58  
 bōhatei 217  
 bōifurendo 24  
 boirā 61  
 bōken 255  
 bōkkuu seki 254  
 bōkō 20, 94  
 bokusasaizu 251  
 bokusāshōtsu 33  
 bokushingu 236  
 bokusō-chi 182  
 bokuyō nōjō 183  
 bongu 257  
 bonnetto 198  
 borādō 298  
 borē 231  
 boribia 315  
 bōringu 249  
 bōru 65, 75, 112, 220, 224,  
 226, 228, 230, 249  
 bōrubōi 231  
 bōsai ono 95  
 bōshi 36  
 boshikyū 15  
 bosunia herutsegobina 316  
 bōtakatobi 234  
 botan 32, 111  
 botanhōru 32  
 botchangari 39  
 bōto 214  
 botoru 61  
 botsuwana 317  
 budō 127, 237  
 budō abura 134  
 budō no ki 183  
 budōen 183  
 bui 217  
 buinekku 33  
 būke 35, 111  
 būkegaruni 132  
 bumben 52  
 bumbetsu yunitto 61  
 bumbo 165  
 bumbōgu 105  
 būmu 240  
 būmumaiku 179  
 buna 296  
 bundoki 165  
 bungaku 162, 169  
 bunki-tai 194  
 bunrui-dana 100  
 bunryō 151  
 bunshi 165, 297  
 bunsū 165  
 bunzen bānā 166  
 burajā 35  
 burajiru 315  
 burajirunattsu 129  
 burakku hōru 280  
 burakku kōhi 148  
 burakku pudingu 157  
 burakkuberi 127  
 burakkukaranto 127  
 burandē 145  
 buranko 263  
 burashi 40, 77  
 burashi o kakeru 38  
 burausu 34  
 burauza 177  
 bureddo naifu 68  
 burēdo 66  
 burēki 200, 204, 206  
 burēki furūdo tanku 202  
 burēki o kakeru 207  
 burēki paddo 207  
 burēki pedaru 205  
 burēki rebā 207  
 buresuretto 36  
 burezā 33  
 burī chizu 142  
 burīfu 33  
 burīfukēsu 37  
 burīiji 258, 273  
 burioosshu 157  
 burō suru 38  
 burōchi 36  
 burōkā 97  
 burokkori 123  
 burokku suru 227  
 burondo 39  
 burū chizu 136  
 burūberī 127  
 burugaria 316  
 burukinafaso 317  
 burunei 319  
 burunetto 39  
 burunji 317  
 burūsu 259  
 būsutā 281  
 buta 185  
 butagoya 185  
 butai 254  
 būtan 318  
 butaniku 118  
 būti 30  
 butikku 115  
 butsuri 162  
 butsurigaku 169  
 buyō gakuin 169  
 byō 304  
 byōin 48  
 byōki 44  
 byōki no 321  
 byōri-ka 49  
 byōshin 304  
 byōshitsu 48  
 byuffe 152  
 C  
 cha 184  
 chado 317  
 chairu 274  
 chairudo shito 198, 207  
 chakka-zai 266  
 chakku 78  
 chako 276  
 chakuriku sōchi 210  
 chakuriku suru 211  
 chan 23  
 channeru 178  
 channeru o kaeru 269  
 chatsune 135  
 chawan 64  
 chedā chizu 142  
 chekkā 272  
 chekkuauto 106  
 chekkuin suru 212  
 cheko kyōwakoku 316  
 chekuin desuku 213  
 chēn 36, 206  
 chero 256  
 chesu 272  
 chesuban 272  
 chesuto puresu 251  
 chi'iki 315  
 chiaridā 220  
 chibusa 12  
 chichi 22  
 chichi o shiboru 183  
 chichūkai 313  
 chihō 315  
 chijin 24  
 chikai 320  
 chikaku 282  
 chikashitsu 58  
 chikatetsu 208  
 chikatetsu rosenzu 209  
 chiketto uriba 255  
 chikin bāgā 127  
 chikin nageetto 155  
 chikori 122  
 chiku 315  
 chikubi 12, 75  
 chikusha 185  
 chikyū 280, 282  
 chīmu 220, 229  
 chindei 85  
 chingensai 123  
 chinjutsu-sho 180  
 chinsei-zai 109  
 chippu 152  
 chippubōdo 79  
 chippushotto o utsu 233  
 chiri 162  
 chiritori 77  
 chisai 321  
 chisei 284  
 chissoku suru 47  
 chitai 283, 315  
 chitsu 20  
 chizu 195, 261  
 chizu 136, 156  
 chō 295  
 chōba 235  
 chōdo 320  
 chōge 300  
 chōha 179  
 chōhen eiga 269  
 chōhōkei 164  
 chōji 125  
 chōka hikidashi 96  
 chōka nimotsu 212  
 chokin 96  
 chokkei 164  
 chokobā 113  
 chōkoku 275  
 chōkokuka 191  
 chōkokutō 275  
 chokorēto 113  
 chokorēto chippusu 141  
 chokorēto kēki 140  
 chokorēto mirukusēki 149  
 chokorēto o kabueta 140  
 chokorēto supureddo 135  
 chōku 162  
 chokuchō 21  
 chokuryū denryū 60  
 chokusen 165  
 chōkyori basu 196  
 chōnekutai 36  
 chōmpa (kensa) 52  
 chōmpa jettoki 211  
 choppu 119  
 chōri 67  
 chōri niku 143  
 chōri shitsu 214  
 chōri yōgu 68  
 chōri-zumi niku 118  
 chōridai 66  
 chorisō 143  
 chōruui 292  
 chōryū 130  
 chōsa 94  
 chōsei taku 179  
 chōshin 304  
 chōshinki 45  
 chōshoku 64, 156  
 chōshoku byuffe 156  
 chōshoku no tēburu 156  
 chōshoku torei 101  
 chōshoku-tsuki 101  
 chosui tanku 61  
 chōten 164  
 chōyaku-ban 235  
 chōzai shitsu 108

chūba 257  
 chūbei 314  
 chūbu 207, 311  
 chuchu 191  
 chūdoku 46  
 chūgaeri 235  
 chūgoku 318  
 chūha 179  
 chūi 323  
 chūka nabe 69  
 chūkanken 286  
 chūko hambaiten 115  
 chūmon suru 153  
 chunijia 317  
 chūō afurika kyōwakoku 317  
 chūō bunri-tai 194  
 chūō enzan shori sōchi 176  
 chūō shasen 194  
 chūrippu 111  
 chūsha 48  
 chūsha kinshi 323  
 chūsha suru 195  
 chūsha-bari 109  
 chūshajō 298  
 chūshaki 109, 167  
 chūshin 164  
 chūshoku 64  
 chūshukotsu 17  
 chūsokkotsu 17

## D

daburu 151  
 daburu beddo 71  
 daburu kurīmu 137  
 daburu rūmu 100  
 daburusu 230  
 dachō 292  
 daenkei 164  
 daffurukōto 31  
 dagakki 257  
 dagu-auto 229  
 daichi 284  
 daichō 18  
 daidenkin 16  
 daidokoro 66  
 daidokoro yōhin 105  
 daigaku 168, 299  
 daigakuin 169  
 daigakusei 169  
 daihon 254  
 daikaiten 247  
 daikei 164  
 daiku 188  
 daimeie 168  
 dainamo 207  
 dainingu rūmu 64  
 daiō 127  
 dairi 223  
 dairiseki 288  
 daiseidō 300  
 daitai ryōhō 54  
 daitaikotsu 17  
 daiuikyō 133  
 daiya 273  
 daiyamondo 288  
 daizu 131  
 damī 276

dampukā 187  
 damu 300  
 danberu 251  
 danchigai heikōbō 235  
 dankushūto suru 227  
 danmenzu 282  
 danro 63  
 dansā 191  
 danseie 12, 13, 21, 23  
 danseie fuku 32  
 danshi seito 162  
 dansu 259  
 dasshubōdo 201  
 dassui suru 76  
 dassuiki 76  
 dasutā 77  
 dāto baiku 205  
 dātsu 273  
 dātsubōdo 273  
 daunrōdo suru 177  
 de 320  
 debitto kādo 96  
 deddōbōru rain 221  
 deguchi 322  
 deguchi rampu 194  
 dejitaru kamera 270  
 dekki 85  
 dekki chea 265  
 dempō 98  
 den'atsu 60  
 denchi 167, 260  
 denchi paku 78  
 dengem 60  
 dengem kēburu 176  
 dengem sōchi 266  
 denki doriru 78  
 denki kamisori 73  
 denki kigu 66  
 denki seihin 105, 107  
 denki setsubi 60  
 denki yakan 66  
 denkiō 188  
 denkimōfu 71  
 denkyū 60  
 denmāku 316  
 denriken 286  
 denyoku 60  
 denyokuryō-kei 60  
 densen 60  
 densha 208  
 denshimēru 177  
 denshirenji 66  
 denshitechō 175  
 dentaku 165  
 dentaru furosu 50, 72  
 dentaru furosu de sōji suru 50  
 denwa 99, 172  
 denwa ni deru 99  
 denwa suru 99  
 deodoranto 73, 108  
 depāto 105  
 derikatessen 107, 142  
 desukutoppu 177  
 desukutoppu ōganaizā 172  
 dezainā 191, 277  
 dezāto 153

dezāto wagon 152  
 di-bui-di disuku 268  
 di-bui-di purēyā 268  
 difendingu zōn 224  
 dijitaru 269  
 dijon masutādo 135  
 diru 133  
 disuku 176  
 disuku jokki 179  
 diwāri 27  
 dizeru 199  
 dizeru kikansha 208  
 dō 235, 289  
 doa 196, 198, 210  
 doa handoru 200  
 doa mirā 198  
 doa rokku 200  
 doachēn 59  
 doanokkā 59  
 dōbā karei 120  
 dōbutsu 290, 292, 294  
 dōbutsuen 262  
 dōbutsugaku 169  
 dōgu 187  
 dōgubako 80  
 doitsu 316  
 dojō 85  
 dokku 214, 216  
 dōkō 51  
 dokubari 295  
 dokusho risuto 168  
 dokusho-tō 210  
 dōkutsu 284  
 dokyumentarī 178  
 dokyumento fairu 173  
 dōmā 58  
 dominika 314  
 dominika kyōwakoku 314  
 domino 273  
 dōmyaku 19  
 donabe 69  
 donaru 25  
 donguri kabocha 125  
 dora 257  
 dorai furawā 111  
 dorai furūtsu 129, 156  
 doraibā 80  
 doraibā bitto 80  
 doraibāshotto o utsu 233  
 doramā 258  
 doramu 258  
 doramu setto 258  
 doreshshingu o kaketa 159  
 doriburu suru 222  
 doriru 50  
 doriru bitto 78, 80  
 dōro 194  
 dōro hyōshiki 195, 298, 323  
 dōro kōji 187, 195  
 dōro kōji-chū 323  
 doroppu shotto 230  
 doroyoke 205  
 dōru hausu 75  
 dōryō 24  
 doseie 280  
 dōtsuki noko 81  
 doyōbi 306

dōzo 322  
 dyūsu 230

## E

e 36, 62, 187, 274, 320  
 ē tī emu 97  
 ē-pi-esu kamera 270  
 ea firutā 202, 204  
 eā mattoresu 267  
 eabaggu 201  
 eakon 200  
 earobaiku 250  
 earobikusu 251  
 echiopia 317  
 eda 296  
 eda tsuno 291  
 edage 39  
 edamu chizu 142  
 edawake suru 91  
 efude 274  
 egaku 162  
 eggu kappu 65, 137  
 ehagaki 112  
 ei 294  
 eiga 255  
 eiga no setto 179  
 eigakan 255, 299  
 eigyō bu 175  
 eihō 239  
 eikō-sen 215  
 eikoku 316  
 eiseie antena 269  
 eishamaku 255  
 eijiputo 317  
 eijii 246  
 eki 208  
 ekika 127  
 ekitai keiryōki 311  
 ekitai senzai 77  
 ekitai-gusuri 109  
 ekonomī kurasu 211  
 ekuadoru 315  
 ekubo 15  
 ekuiti 97  
 ekurea 140  
 emarushon 83  
 emban-nage 234  
 embosu kabegami 83  
 emerarudo 288  
 empitsu 163, 275  
 empitsu-kezuri 163  
 emu di efu 79  
 emu-pi-suri purēyā 268  
 enamerushitsu 50  
 enchō jikan 223  
 enchō kōdo 78  
 enchō suru 168  
 enchū 164  
 endaibu 123  
 endo zōn 220  
 endōmame 122  
 endorain 226  
 engan-keibitai 217  
 engeie 90  
 engeie sentā 115  
 engeie yōhin 88  
 engeie-yō tebukuro 89

enjin 202, 204, 208, 210  
 enjo 322  
 enkeie 164  
 enkin ryōyō 51  
 enko 164  
 enogu 274  
 enshi 51  
 ensū 164  
 ensui 164  
 entotsu 58, 214  
 epuron 30, 50, 69, 212  
 era 294  
 erebetā 59, 100, 104  
 erekigita 258  
 eri 32  
 eritoria 317  
 erizukami 237  
 erusarubadoru 314  
 esa 244  
 esa o ataeu 183  
 esharotto 125  
 ēsu 230, 273  
 esu-efu eiga 255  
 esukarētā 104  
 esuppresso 148  
 esute 41  
 esutonia 316  
 etchingu 275  
 etsuran shitsu 168  
 etsuran suru 177

## F

fagotto 257  
 faindā 271  
 fairingu kyabinetto 172  
 fairu 172, 177  
 faiyā sukurin 63  
 fakkusu 172  
 fam beruto 203  
 famburu 220  
 fan 202, 258  
 fandēshon 40  
 fanhitā 60  
 fashon 277  
 fasunā 277  
 fāsuto fūdo 154  
 fauru 223, 226  
 fauru bōru 228  
 fauru rain 229  
 feaweie 232  
 feijoa 128  
 feisu 230  
 fenshingu 249  
 fenuguriku 132  
 ferī 215, 216  
 ferī noriba 216  
 fēsharu 41  
 fēsu kurīmu 73  
 fēsu masuku 225  
 fēsu paku 41  
 fēsu-ofu sākuru 224  
 figyuasukēto 247  
 fiji 319  
 finrando 316  
 firamento 60  
 firipin 319  
 firos pesutorī 140



- firudingu suru 229  
 firudo hokkē 224  
 firumu 260, 271  
 firumu kauntā 270  
 firutā 270  
 firutā kōhi 148  
 fīto 310  
 fittonesu 250  
 fittonesu kigu 250  
 fō doa 200  
 foahando 231  
 fōku 65, 88, 153, 207  
 fōku 259  
 fōku rifuto 186  
 fōkurando shotō 315  
 fōkurifuto 216  
 fōmaru-na teien 84  
 fonto 177  
 foruda 177  
 foruto 230  
 fowādo 222  
 fuan 25  
 fuchi'ishi 298  
 fudansō 123  
 fudebako 163  
 fūdo 31, 75  
 fūdopuroressā 66  
 fudōsan-ya 115, 189  
 fuhenkashi 320  
 fujin fuku 105  
 fujin-ka 49  
 fujinka-i 52  
 fukami 239  
 fuke 39  
 fukikesu 141  
 fukkatsusai 27  
 fukkin 16  
 fukkin undō 251  
 fukku 187  
 fuku 77  
 fukuboku 47  
 fukurahagi 13  
 fukurashiko-iri komugiko  
 139  
 fukureru 139  
 fukuro 291, 311  
 fukurō 292  
 fukusayō 109  
 fukusha suru 172  
 fukushin 223  
 fukusōjūshi 211  
 fukutsū 44  
 fukuyōki 211  
 fukyoku 167  
 fuminshō 71  
 fun 304  
 fune 214  
 funinshō 20  
 funka suru 283  
 funkakō 283  
 funkikō 290  
 funmatsu senzai 77  
 funmu suru 91  
 funnyū 137  
 funōshō 20  
 funsui 85  
 furaggu 232
- furaggu posuto 221  
 furai 244  
 furai fīshingu 245  
 furaido chikin 155  
 furaido poteto 154  
 furaigaeshi 68  
 furaipan 69  
 furaishito 266  
 furajore mame 131  
 furamingo 292  
 furan 142  
 furansu 316  
 furashi 244  
 furasshu gan 270  
 furasoku 166  
 furatto 216  
 furatto uddo bitto 80  
 furattobureddo 139  
 furēku 132  
 furēmu 51, 206, 267  
 furenchi horun 257  
 furenchi puritsu 39  
 furenchi tōsuto 157  
 furette 258  
 furi kikku 222  
 furi weito 250  
 furijia 110  
 furippā 239  
 furippu chāto 174  
 furisu 74  
 furisurō rain 226  
 furizu 301  
 furo ni hairu 72  
 furonto 100  
 furonto garasu 198  
 furonto garasu senjōeki 199  
 furonto-gakari 100  
 furorentin 141  
 furōzun yōguruto 137  
 furui 89, 321  
 furui ni kakeru 91, 138  
 furūre 249  
 furūto 257  
 furūtsu gamu 113  
 furūtsu kēki 140  
 furūtsu pan 139  
 furūtsu sarada 157  
 furūtsu taruto 140  
 furūtsu yōguruto 157  
 fusa 122, 126  
 fūsui 55  
 fusuma 130  
 futa 61, 66, 69  
 futago 23  
 fūtō 98, 173  
 futoi 321  
 futomomo 12  
 futon 71  
 futōzai 199  
 futsū 39, 99  
 futsuryō giana 315  
 futsūyokin kōza 96  
 futtobōdo 71  
 futtobōru kyōgijō 220  
 futtobōru senshu 220  
 futtosutorappu 241  
 fuyu 31, 307
- G**  
 ga 295  
 gābera 110  
 gabon 317  
 gabyō 173  
 gachō 119, 293  
 gachō no tamago 137  
 gādo rēru 195  
 gādo shita tsūro 194  
 gaido-tsuki tsuā 260  
 gaika 97  
 gaikaku 282  
 gaikan 28  
 gaikiken 286  
 gaikokugo 162  
 gairaikanja 48  
 gaishoku 146  
 gaishutsu 75  
 gaisō 198  
 gaitō 298  
 gaiya 229  
 gaka 191, 274  
 gake 285  
 gakkī 256, 258  
 gakkō 162, 299  
 gakkō no seifuku 162  
 gakkotsu 17  
 gaku 297  
 gakubu 169  
 gakubuchi 62  
 gakufu 255, 256  
 gagugyō 162  
 gakui 169  
 gakui-rombun 169  
 gakumen kingaku 97  
 gakunen 163  
 gakusei ryō 168  
 gakusei shokudō 168  
 gakashū 160  
 gambia 317  
 gamen 97, 176, 269  
 gamu 113  
 gan-ka 49  
 gāna 317  
 gānetto 288  
 gangiei 120, 294  
 gangiei no hire 120  
 ganka 49  
 ganseki 288  
 garagara 74  
 gārando 111  
 garapagosu shotō 315  
 garasu bin 166  
 garasubō 167  
 garasusei 69  
 gārīkku puresu 68  
 garon 311  
 gārūfurendo 24  
 gasorin 199  
 gasorin pompu 199  
 gasorin sutando 199  
 gasu konro 267  
 gasubānā 61  
 gasuketto 61  
 gasurenji 67  
 gātā 35
- gatto 230  
 gaun 38  
 gazai-ya 115  
 gāze 47  
 gedan 141  
 geka 49  
 geka-i 48  
 geki 254  
 gekijō 254, 299  
 gekkei 20  
 gembugan 288  
 gēmu 230, 272, 273  
 gēmu bangumi 178  
 gen 258  
 gengakki 256  
 genkan 59  
 genkan matto 59  
 genkan-tō 58  
 genmai 130  
 genmon 214  
 gensō 214  
 genzai 304  
 genzō suru 271  
 gerende 246  
 gerende-gai 247  
 geri 44, 109  
 gesen suru 217  
 gesuidō 299  
 gēto bangō 213  
 getsuyōbi 306  
 gezai 109  
 gia bokkusu 202, 204  
 giana 315  
 gibo 23  
 gibusu 46  
 gichō o tsutomeru 174  
 gidai 174  
 gifu 23  
 gifuto shoppu 114  
 gijiroku 174  
 gikyōdai 23  
 gin 235, 289  
 gingakei 280  
 ginia 317  
 giniabisau 317  
 ginkō 96  
 ginkō furikomi 96  
 ginkō tesūryō 96  
 giri no shimai 23  
 girisha 316  
 gishigishi 123  
 gitarisuto 258  
 go 308  
 go banme 309  
 gōban 79  
 gogatsu 306  
 gogo 305  
 gōguru 238, 247  
 gohan 158  
 gohan-jawan 64  
 gohyaku 308  
 gojū 308  
 gojū banme 309  
 gokakkei 164  
 gokiburi 295  
 goma 131  
 goma'abura 134
- goman 309  
 goman gosen gohyaku 309  
 gomi okiba 266  
 gomibako 61, 67, 172, 177  
 gomishori 61  
 gomishori-ki 61  
 gomubōto 215  
 gomuin 173  
 gomunagagutsu 89  
 gomuzōri 37  
 goraku 252  
 goraku kaden 268  
 gorira 291  
 gōru 221, 222, 223, 224, 234  
 gōru eria 223  
 gōru netto 226  
 gōru rain 220, 223, 224  
 gōru ringu 226  
 gorufā 232  
 gorufu 232  
 gorufu baggu 233  
 gorufu bōru 233  
 gorufu kato 232  
 gorufu kōsu 232  
 gorufu kurabu 233  
 gorufu shūzu 233  
 gōrukupā 222, 224  
 gōruposuto 220, 222  
 gōsei sen'i 31  
 gosenufu 256  
 goshigoshi arau 77  
 goshikku 301  
 goshin 237  
 gu 140, 155  
 guaba 128  
 guatemara 314  
 gun'yō 110  
 guraidā 211, 248  
 guraidingu 248  
 gurajiorasu 110  
 guranu 310  
 guranari bureddo 139  
 gurando 234  
 gurando kabā 87  
 gurando shīto 267  
 gurasu 150, 152  
 guratan-zara 69  
 gurauto 83  
 gurē 39  
 gurenada 314  
 gurēpu jūsu 144  
 gurēpufurūtsu 126  
 gurēzu o nuru 139  
 gurin 232  
 gurin pīsu 131  
 gurin sarada 158  
 gurinrando 314  
 gurippu 230  
 gurirupan 69  
 gurōbu 224, 233, 237, 246  
 gurū gan 78  
 gurujia 318  
 gurūpu ryōhō 55  
 gūzuberī 127  
 gyokō 217  
 gyōmu 183  
 gyōretsū 27

- gyorui 294  
gyosen 217  
gyūniku 118  
gyūnyū 136, 156  
gyūnyū katon 136
- H  
ha 50, 89, 122, 296  
ha no teire 72  
haba 165  
haba no hiroi 321  
haba no semai 321  
habu 206  
hābu 86, 133, 134  
hābu cha 149  
hābu no bōdā kadan 85  
hābu to kōshinryō 132  
hābu-en 84  
haburashi 72  
hachi 295, 308  
hachi banme 309  
hachidori 292  
hachigatsu 306  
hachijū 308  
hachijū banme 309  
hachō 179  
hachūruui 293  
hada no iro 41  
hadagi 30, 33  
hādo chizu 136  
hādo doraibu 176  
hādobōdo 79  
hādorūsō 235  
hādowea 176  
hae 295  
hafu 300  
hāfu taimu 223  
hagasu 82  
hageatama 39  
haguki 50  
haha 22  
hai 18, 52, 322  
hai'iro 274  
haichea 75  
haichi 314  
haidenki 203  
haigūsha 23  
haihiru 37  
haikan setsubi 61  
haikankō 188  
haikei 254  
haiki-kan 203, 204  
haikingu 263  
haikingu būsū 37, 267  
hairaito 39  
hairan 20, 52  
haisha 50, 189  
haisui 91  
haisuikan 61  
haisuikō 72, 299  
haisuikokku 61  
haita 50  
haitatsu 98  
haitō 97  
haiyaku 254  
haiyū 179, 191, 254  
haizara 150
- hajime 321  
hakari 69, 98, 118, 310  
hakarū 310  
hakase gō 169  
hake 69, 83  
hakike 44  
hakka 133  
hakka ame 113  
hakkakkei 164  
hakkō saseru 139  
hako-gata fairu 173  
hakozone chokorēto 113  
haku 44, 77, 90  
hakua 288  
hakubutsukan 261  
hakuchō 293  
hakumai 130  
hakunaishō 51  
hakurikō 139  
hakusai 122  
hakushu suru 255  
hamaki 112  
hambāgā 154, 155  
hambāgā-ya 154  
hami 242  
hamigaki suru 50  
hamigaki yōhin 108  
hamigakiko 72  
hammoku 266  
hamu 119, 143, 156  
hamusutā 290  
hamusutoringukin 16  
hana 14, 110, 291, 293, 297  
hana no ana 14  
hana sen 238  
hana-gawa 242  
hanabira 297  
hanaji 44  
hanareya 182  
hanashiau 163  
hanashigai no 118  
hanasu 245  
hanataba 111  
hanawa 111  
hanaya 110, 188  
handa 79, 81  
handagote 81  
handazuke suru 79  
handikyappu 233  
hando doriru 78, 81  
hando fōku 89  
hando taoru 73  
handobaggu 37  
handoburēki 303  
handoru 201  
handorubā 207  
hane 60, 293  
hanebuton 71  
hanemūn 26  
hanga 275  
hangā 70  
hangari 316  
hangigo 320  
hangingu basuketto 84  
hangu guraidā 248  
hangu guraidingu 248  
hanikamu 25, 134
- hankachi 36  
hankei 164  
hanken 96  
hanketsu 181  
hansen 215  
hanshakyō 50, 167  
hanshazai 205  
hantō 282  
hanzai 94  
hanzai-reki 181  
hanzai-sha 181  
hanzubon 30  
happō 144  
happyaku 308  
hāpu 256  
hara 12  
harai 237  
haraobi 242  
hare 286  
hari 186, 276  
hari ita 276  
hari ni kakaru 245  
hari ryōhō 55  
harigane 79  
harikēn 287  
hariko 191, 275  
harinezumi 290  
harisashi 276  
harowin 27  
haru 307  
hasami 38, 47, 82, 188, 276  
hashi 64, 300  
hashigo 95, 186  
hashika 44  
hashira 300  
hashirihabotobi 235  
hashiritakatobi 235  
hashiru 229  
hassha 281  
hasshadai 281  
hasui suru 52  
hata 277  
hatake 182  
hataori 277  
hatchibakku 199  
hato 292  
hātō 273  
hatoba 216  
hatoba ni tsukeru 217  
hatsudenki 60  
hatsukanezumi 290  
hatsunetsutai 61  
hawai 314  
haya'ashi 243  
hayabusa 292  
hayai 305, 320, 321  
hayaokuri 269  
hazādo rampu 201  
hazukashi 25  
hazumi-guruma 276  
hazuna 243  
hea karā 39  
heabando 38  
heaburashi 38  
headoraiyā 38  
heakarā 40  
heapin 38
- heasupurē 38  
heatai 39  
hebi 293  
hebi metaru 259  
hechima 73  
heddo raito 198, 205  
heddo resuto 200  
heddobōdo 70  
heddogādo 236  
heddohon 268  
heddosēru 240  
hedingu suru 222  
heichi kyōsō 243  
heihō fito 310  
heihō mētoru 310  
heikan 260  
heikindai 235  
heikōbō 235  
heikōsen 165  
heikōshihenkei 164  
heimen kikagaku-shiki teien 262  
heimenzukei 164  
heishi 189  
heiya 285  
hekimen shōmei 62  
hemataito 289  
hen'atsuki 60  
hengan 288  
henkyaku-bi 168  
henmagan 288  
henseigan 288  
henshū-sha 191  
hensoku ki 202, 206  
hensoku rebā 201  
hensoku suru 207  
henzutsū 44  
heon kigō 256  
hera 68, 167  
herikoputā 211  
herumetto 95, 186, 204, 206, 220, 228, 242  
heso 12  
hesono'o 52  
heya 58  
heya bangō 100  
heya no kagi 100  
hēzerunattsu 129  
hēzerunattsu oiru 134  
hi o tsukeru 266  
hi'iragi 296  
hidari 260  
hidari desu 323  
hidari handoru 201  
hidokei 262  
hifu 14  
hifu-ka 49  
hifukukin 16  
higashi 312  
higashi timōru 319  
hige 290  
higesori 73  
higesori kurīmu 73  
higisha 180  
hiji 13  
hijikake 210  
hijō kaidan 95
- hijō rebā 209  
hijō-guchi 210, 322  
hikaekabe 301  
hikidashi 66, 70, 172  
hikiageru 294  
hikiniku 119  
hikinobashi 271  
hikiwake 223  
hikiyoseru 245  
hikōki o yoyaku suru 212  
hikoku-gawa 181  
hikokunin 181  
hikotsu 17  
hiku 165  
hikui 321  
himaraya sanmyaku 313  
himarayasugi 296  
himawari 184, 297  
himawari abura 134  
himawari no tane 131  
himeji 120  
himpan ni 320  
hinagiku 110, 297  
hinichi 306  
hinin 21  
hinode 305  
hinyōki kei 19  
hinyōki-ka 49  
hiraite 321  
hiraoyogi 239  
hiraya 58  
hire ashi 290  
hire niku 119  
hiroba 299  
hirokuchi bin 311  
hiryō 91  
hiryō o yaru 91  
hishi no mi 124  
hishigata 164  
hisu 297  
hisui 288  
hitā 60  
hitā chōsetsu 201  
hitai 14  
hitai-gawa 242  
hito 10  
hitode 295  
hitokire 140  
hitoribun 64  
hitosashiyubi 15  
hitsuji 185  
hitsuji no mure 183  
hiyake 41, 46  
hiyake rōshon 265  
hiyakedome 108, 265  
hiyoke-bō 30, 265  
hiyoko 185  
hiyoko mame 131  
hiza 12  
hiza-take 34  
hiza'ate 205  
hizō 18  
hizume 242, 291  
hō 14  
ho'on uea 267  
ho'onzai 61  
hobākura futo 215

hōbeni 40  
hochikisu 173  
hōchō 68  
hōchō togi-ki 68  
hodō 262, 298  
hōdō 178  
hodoku 277  
hofuku shokubutsu 87  
hōgaku 169  
hōgannage 234  
hōgō 52  
hogo megane 81  
hōhi 21  
hoikuki 53  
hoippu kurimu 137  
hoiru 207  
hoiru kyappu 202  
hoiru natto 203  
hojirin 207  
hojoyoku 210  
hōkaiseki 289  
hoken 203  
hoketsusenshu 223  
hōki 77  
hokkai 312  
hokkē 224  
hokkē-yō sutikku 224  
hokkyoku 283  
hokkyokuguma 291  
hokkyokukai 312  
hokkyokuken 283  
hōkō shijiki 198, 204  
hōkōda 210  
hōkokusho 174  
hokori o harau 77  
hokoru 25  
hokōsha-tengoku 299  
hokubei 314  
hokuro 14  
hokyū suru 220, 229  
homeopashi 55  
homojinaizu 137  
hōmu 208  
hōmu bangō 208  
hōmu bēsu 228  
hōmu bu 175  
hon 168  
hon'i kigō 256  
hon'ya 115  
hondana 63  
hone 17, 119, 121  
hone o totta 121  
honjurasu 314  
honsha 175  
honsō-gaku 55  
honyūbin 75  
honyūru 290  
horā eiga 255  
hōrensō 123  
hori 300  
hōritsu 180  
hōritsu jimusho 180  
hōritsu sōdan 180  
horu 90  
hōru 232  
hōru in wan 233  
horumon 20

hōrutā nekku 35  
hōseki 36, 288  
hōseki-bako 36  
hōseki-shō 188  
hōseki-ten 114  
hoshakukin 181  
hōshasen-ka 49  
hoshi 280  
hoshibudō 129  
hoshikusa 184  
hōsō 179  
hōsō suru 178  
hōsō-shi 111  
hosoi 321  
hosshin 44  
hōsu 89, 95  
hōsu rīru 89  
hōtai 47  
hotategai 121  
hōtei 180  
hōtei kakari-kan 180  
hoteru 100, 264  
hotto doggu 155  
hotto kokoa 144, 156  
howaitingu 120  
howaito 39  
howaito chokorēto 113  
howaitokaranto 127  
hazon shori 118, 143, 159  
hazon suru 177  
hyakkajiten 163  
hyaku 308  
hyaku banme 309  
hyakubunritsu 165  
hyakujū 308  
hyakuman 309  
hyō 286  
hyōdo 85  
hyōga 284  
hyōhakuzai 77  
hyōketsu 287  
hyōshiki 322  
hyōshō dai 235  
hyūzu 60  
hyūzu bokkusu 203

I

i 18  
ibiki o kaku 71  
ibuningudoresu 34  
ichi 308  
ichi banme 309  
ichi-ji han 304  
ichi-ji jūgo-fun 304  
ichiba 115  
ichigan-refu kamera 270  
ichigatsu 306  
ichigo 127  
ichigo no mirukusēki 149  
ichijiku 129  
ichijiteishi 269  
ichiman 309  
ichinensō 86  
ichirin daisha 88  
ido 283  
ie 322  
iemen 318

ierō kādo 223  
igaku 169  
igo 320  
iguana 293  
igunisschon 200  
igusa 86  
ika 121, 295  
ikari 214, 240  
ikari o orosu 217  
ike 85  
ikegaki 182  
ikikata 260  
ikkai 104  
ikkai seki 254  
ikkodate 58  
ikōru 165  
ikutsuka no 320  
ima 62, 320  
imin suru 26  
imomushi 295  
in-gōru 221  
inago 295  
inazuma 287  
inchi 310  
indekkusu 173  
indo 318  
indonesia 319  
indoyō 313  
infuruenza 44  
inga 271  
ingashi 271  
ingenname 122, 313  
ingurisschu burekkufasuto 157  
ingurisschu horun 257  
ingurisschu masutādo 135  
iningu 228  
inko 293  
inku 275  
innō 21  
insatsu suru 172  
insei shokubutsu 87  
inshin 20  
insurin 109  
insutanto kamera 270  
insutanto shokuhin 107  
insutōru suru 177  
intabyūā 179  
intāhon 59  
intānetto 177  
intāshiti ressha 209  
intō 19  
inu 290  
inu-zori suberi 247  
iō 289  
ippōtsūkō 194, 298, 323  
iraku 318  
irakusa 297  
iran 318  
ireba 50  
ireru 76  
irezumi 41  
iriguchi 59, 322  
iro 274  
iro-empitsu 163  
iroai 41  
iroguro 41  
irojiro 41

iruka 290  
iryō bumon 49  
iryō sentā 168  
ise ebi 121  
isha 45, 189  
ishikifumei 47  
ishō 255  
isozuri 245  
isu 64  
isuraeru 318  
itachoko 113  
itameru 67  
itameta 159  
itami-dome 47, 109  
itaria 316  
ito 276  
ito annai 276  
ito maki 276  
ito o tōsu 277  
itoko 22  
itonoko 81  
itsu 44  
itsumo 320  
itta 129  
itten ageru 223  
iwa 284  
iwashi 120  
iyakuhin 109  
iyaringu 36  
izen 320  
izeru 174, 274

J

jagaimo 124  
jaguchi 61, 66  
jaketto 34  
jakkī 203  
jaku 273  
jamaika 314  
jampu 243, 247  
jampu bōru 226  
jampu suru 227  
jamu 156  
jānarisuto 191  
janguru jimu 263  
jankushon 194  
jari 88  
jazu 259  
jeru 38, 109  
jetto 288  
jetto kōsutā 262  
jettosuki 241  
ji 304  
ji'in 300  
jibi'in-kō-ka 49  
jidō doa 196  
jidō hikiotoshi 96  
jidōsha 198, 200  
jidōsha jiko 203  
jidōsha rēsu 249  
jigūso 78  
jigūso pazuru 273  
jikan 234, 261, 304  
jikan-dōri 305  
jikayō jettoki 211  
jikken 166  
jikken shitsu 166

jiko 46  
jiko saikō kiroku 234  
jikokuhyō 197, 209, 261  
jimbabue 317  
jimu 101  
jimu kiki 172  
jimu yōhin 173  
jimusho 172, 174  
jin 145  
jinji bu 175  
jinkōeisei 281  
jinsei 26  
jintai 17  
jintai keitō 19  
jintonikku 151  
jintsū 52  
jintsū sokushin suru 53  
jinzō 18, 199  
jiopotū 51  
jipan 31  
jipuchi 317  
jishaku 167  
jishin 25, 283  
jisho 163  
jitensha 206  
jitensha ni noru 207  
jitensha raku 207  
jitensha-dō 206  
jizai supana 80  
jō 59  
jōba 242, 263  
jōba muchi 242  
jōba zubon 242  
jōba-dō 263  
jōba-gutsu 242  
jōgi 163, 165  
jōgingu 251, 263  
jōkā 273  
jōki kikansha 208  
jōkō eki 41  
jōkyoku 256  
jōmuin 210  
jōmyaku 19  
jōro 89  
jōryokuju 86  
josampū 53  
josei 12, 20, 23  
josei fuku 34  
jōsen suru 217  
jōsen-guchi 281  
jōshaken 197  
joshi seito 162  
jōso 181  
josō suru 91  
josōzai 91, 183  
jōwankotsu 17  
joyū 254  
jōzai 109  
jū 308  
jū banme 309  
jūden-shiki doriru 78  
jūdō 236  
juerī seisaku 275  
jūgatsu 306  
jūgo 308  
jūgo banme 309  
jūgo-fun 304



jūgyō 163  
 jūgyōin 24, 175  
 jūgyōin meibo 175  
 jūhachi 308  
 jūhachi banme 309  
 juhi 296  
 jūi 189  
 jūichi 308  
 jūichi banme 309  
 jūichigatsu 306  
 jūku/jūkyū 308  
 jūkyū banme 309  
 jūman 309  
 jumbi undō o suru 251  
 jūnan shiagezai 76  
 jūnana banme 309  
 jūnenkan 307  
 jūni 308  
 jūni banme 309  
 jūnigatsu 306  
 jūnishichō 18  
 juncan kei 19  
 junyū 53  
 junyū burajā 53  
 junyū suru 53  
 jūoku 309  
 jūroku 308  
 jūroku banme 309  
 jūryoku 280  
 jūsan 308  
 jūsan banme 309  
 jusei 20  
 jūshi/jūyon 308  
 jūshichi/jūnana 308  
 jushin suru 177  
 jushin-bako 177  
 jūsho 98  
 jūsu 149  
 jutai 52  
 jūtaku 58  
 jūtaku rōn 96  
 jūtaku-nai setsubi 160  
 jūtan 63  
 jūtenzai 83  
 juwaki 99  
 jūyon banme 309

K

ka 295  
 kā ōdio 201  
 ka'atsutai 45  
 kaba 291  
 kaban uriba 104  
 kabe 58, 186, 222  
 kabegami 82, 177  
 kabegami o harikaeru 82  
 kabegami o haru 82  
 kabegami-bake 82  
 kabegami-yō nori 82  
 kabin 63, 111  
 kabinda 317  
 kābingu fōku 68  
 kabocha 125  
 kabocha no tane 131  
 kabu 97, 124  
 kabuka 97  
 kabushiki 97

kabutomushi 295  
 kachiku 182, 185  
 kachinko 179  
 kadan 85, 90  
 kādigan 32  
 kadō 283  
 kādo 27  
 kādo sōnyū-guchi 97  
 kādo-shiki kōshū-denwa 99  
 kaede 296  
 kaeru 294  
 kaeshi 244  
 kafe 148, 262  
 kafe puresu 65  
 kafunshō 44  
 kafusubotan 36  
 kagaku 162, 166  
 kagakusha 190  
 kagami 63, 71  
 kagi 59, 207  
 kagi hokku 276  
 kagibari 277  
 kagibariami 277  
 kago 106, 207  
 kagu 105  
 kaguya 115  
 kai'in sekkai 52  
 kaibaake 183  
 kaichūdēntō 267  
 kaidan 59  
 kaidan no tesuri 59  
 kaiga 261  
 kaigan 285  
 kaigara 265  
 kaigi 174  
 kaigi shitsu 174  
 kaigi wa nanji desuka 174  
 kaijo bumben 53  
 kaikan 260  
 kaikan jikan 322  
 kaikei 152  
 kaikeishi 97, 190  
 kaimono 102  
 kaimono-bukuro 106  
 kaiōsei 280  
 kairopurakutikku 54  
 kaisambutsu 121  
 kaisatsu-guchi 209  
 kaisha 175  
 kaisui pantsu 238  
 kaiten 238, 247  
 kaiten isu 172  
 kaitō suru 67  
 kaiyō teikisen 214  
 kaji 95, 241  
 kaji bō 240  
 kajino 261  
 kajū 127  
 kajuaruwa 33, 34  
 kajuen 183  
 kakaku 199  
 kakaku hyō 154  
 kakashi 184  
 kakato 13, 15, 37  
 kake 273  
 kakeashi 243  
 kakeru 165

kaki 121, 128, 239  
 kakimawasu 67  
 kakine 85, 90, 182  
 kakitome yūbin 98  
 kakkō 247  
 kakō 285  
 kakō kokumotsu 130  
 kakōgan 288  
 kaku 162  
 kaku-gōri 151  
 kakudai suru 172  
 kakudo 164  
 kakumaku 51  
 kakusei sōchi 209  
 kakushitsu jokyo suru 41  
 kakusui 164  
 kakuteru 151  
 kakutōgi 236  
 kamakiri 295  
 kamanbēru chizu 142  
 kamban 104  
 kambō 181  
 kambojia 318  
 kambu 174  
 kame 293  
 kamera 178, 260, 270  
 kamera dai 178  
 kamera kēsu 271  
 kamera-ya 115  
 kameraman 178  
 kamerūn 317  
 kami 14, 38  
 kami omutsu 30  
 kami paku 311  
 kami yasuri 81  
 kamigata 39  
 kamikizu 46  
 kaminari 286  
 kamisori no ha 73  
 kamiyui 38  
 kamo 119, 185  
 kamome 292  
 kamomiru cha 149  
 kamotsu 216  
 kamotsu ressha 208  
 kamotsu-sen 215  
 kampai 323  
 kampan 214  
 kampari 145  
 kamu beruto 203  
 kamukōdā 260, 269  
 kan 145, 202, 311  
 kan inryō 154  
 kan'yō shokubutsu 87  
 kånabi 201  
 kanada 314  
 kanamonoya 114  
 kanariya 292  
 kanashi 25  
 kanazuchi 80  
 kanden 46  
 kandokku 217  
 kånēshon 110  
 kanfū 236  
 kangarū 291  
 kangofu 45, 48, 52, 189  
 kani 121, 295

kånibaru 27  
 kaniku 124, 127, 129  
 kanja 45  
 kanjō 25  
 kanjō kōsaten 195  
 kanjuku 129  
 kanketsusen 285  
 kankikō 210  
 kankin suru 97  
 kankiri 68  
 kankisen 66  
 kankitsu rui 126  
 kankō 260  
 kankō annai-jo 261, 322  
 kankō annaisho 260  
 kankō basu 197, 260  
 kankō gaido 260  
 kankō kyaku 260  
 kankō meisho 260  
 kankō rūto 260  
 kankoku 318  
 kankyaku 254  
 kankyō 278  
 kanmi supureddo 134  
 kanna 81  
 kanna o kakeru 79  
 kannakuzu 78  
 kannuki 59  
 kanri jimusho 266  
 kansan ritsu 97  
 kanseitō 212  
 kansen 44  
 kansetsu 17  
 kanshasai 27  
 kanshi 53, 167  
 kanshi'in 265  
 kanshitō 265  
 kanshu 181  
 kanshū 233  
 kansō 129, 130  
 kansō hada 41  
 kansō shita 286  
 kansō shitsu 39  
 kansōki 76  
 kantan na 321  
 kantoku 254  
 kantorī 259  
 kanū 214, 241  
 kanzō 18  
 kanzō ame 113  
 kanzume 107  
 kanzume yōki 311  
 kao 14  
 kaori no aru 130  
 kāpetto 71  
 kapoeira 237  
 kappu-gata yōki 311  
 kappuru 24  
 kapuchīno 148  
 kapuseru 109  
 kara 129, 130, 137  
 kārā 38  
 kara hanarete 320  
 kara no 321  
 kara o muita 129  
 karada 12  
 karai 124

karakuchi 145  
 karamatsu 296  
 karanto 129  
 karashi no tane 131  
 karasu 292  
 karasumugi 130  
 karate 236  
 karē 158  
 karēko 132  
 karendā 306  
 kari'ireru 183  
 karibukai 312  
 karidashi 168  
 karifurawā 124  
 karikomī-basami 89  
 karikomu 90  
 kāringu 247  
 karīningurādo 316  
 karīnui suru 277  
 kariru 168  
 karishakuhō 181  
 kārū 39  
 kārū airon 38  
 karudamon 132  
 karui 321  
 karushi 73, 288  
 karūseru 212  
 karushiumu 109  
 karute 48  
 kasa 36, 233  
 kasai keihōki 95  
 kase 277  
 kasei 280  
 kaseigan 288  
 kasetto purēyā 269  
 kasetto tēpu 269  
 kashi 113, 259, 296  
 kashi rui 107  
 kashidashi kauntā 168  
 kashiya 113  
 kashu 191  
 kashūnattsu 129, 151  
 kassōro 212  
 kasu 58  
 kasumisō 110  
 kasupikai 313  
 kasutādo 140  
 kasutādo kurīmu 140  
 kasutamā sābisu 104  
 kata 13  
 katagami 276  
 katai 124, 129, 321  
 katamaran 215  
 katamari niku 119  
 katārū 318  
 katate nabe 69  
 katatsumuri 295  
 katei 56, 62  
 katei saien 85  
 katei yōhin 107  
 kāten 63  
 katēteru 53  
 kātō 100, 106, 208, 213  
 katsu 273  
 katsudō 263  
 katsura 39  
 kattā 80

- kattā naifu 81  
 kattēji chizu 136  
 katto suru 38  
 kaunserā 55  
 kauntā 96, 98, 100, 142, 150  
 kawa 119, 126, 127, 128, 136, 142, 284  
 kawa o muita 121  
 kawa o muku 67  
 kawagishi 284  
 kawagutsu 32, 37  
 kawaita 321  
 kawajan 205  
 kawakasu 76  
 kawamuki-ki 68  
 kawauso 290  
 kaya 267  
 kayakku 241  
 kayōbi 306  
 kazafusutan 318  
 kazambai 283  
 kazan 283  
 kazari 141  
 kaze 44, 241, 286  
 kaze no tsuyoi 286  
 kazoeru 165  
 kazoku 22  
 keana 15  
 kebabu 155, 258  
 kēburu 79, 207  
 kēburu kā 246  
 kēburu terebi 269  
 kechappu 135  
 kega 46  
 keiba 243  
 keibajō 243  
 keibatsu 181  
 keibi 212  
 keibi'in 189  
 keibō 94  
 keibu 52, 94  
 keido 283  
 keiga kyōsō 243  
 keihikōki 211  
 keiji 94  
 keijiban 173  
 keikan 94, 189  
 keikoku 284  
 keikōtō 94  
 keikotsu 17  
 keimusho 181  
 keiran 137  
 keiri bu 175  
 keiryō 310  
 keiryō jagu 69  
 keiryō kappu 311  
 keiryō supūn 109  
 keiryōki 150  
 keiryū 285  
 keiryū sakugu 217  
 keiryū suru 217  
 keisatsu 94  
 keisatsusho 94  
 keisei-geka 49  
 keisenchū 214  
 keishō 23  
 keitai denwa 99  
 keitai mēru 99  
 keito 277  
 keitsui 17  
 keizaigaku 169  
 kēki 140  
 kēki to dezāto 140  
 kēki yaki-gata 69  
 kēki-zukuri 69  
 kēkiya 114  
 kekka 49  
 kekkon hirōen 26  
 kekkon suru 26  
 kekkonshiki 26, 35  
 kembikyō 167  
 kemuri 95  
 kemuri hōchiki 95  
 ken 17  
 ken'insha 203, 212  
 kenchiku 300  
 kenchiku yōshiki 301  
 kenchiku zairyō 187  
 kenchiku-ya 186, 188  
 kenchikuka 190  
 kendō 236  
 kenia 317  
 kenjū 94  
 kenkasei teiboku 87  
 kenkashokubutsu 297  
 kenkō 42, 44, 323  
 kenkō na 321  
 kenkō shokuhin-ten 115  
 kenkōkotsu 17  
 kenkyū 169  
 kenma suru 82  
 kensa 49  
 kensaku suru 177  
 kensatsuin 209  
 kensetsu 186  
 kenshi 50  
 kensui suru 251  
 kenuki 40  
 kēpā 143  
 kerī 237, 239  
 keru 221, 223  
 kēru 123  
 kesagatame 237  
 keshi 297  
 keshi no mi 138  
 keshi'in 98  
 keshigomu 163  
 keshōdai 71  
 keshōhin 41, 105, 107  
 keshōsui 41  
 kessai-bako 172  
 kesshite nai 320  
 kessoku himo 89  
 kēsu 51  
 keta 186  
 ketchappu 154  
 ketorodoramu 257  
 ketsuatsu 44  
 ketsuatsukei 45  
 ketsueki kensa 48  
 kezuru 79  
 ki 86, 296  
 ki 176  
 ki'iro 274  
 kiba 291  
 kibi 130  
 kibōdo 172, 176, 258  
 kidō 280  
 kifuhō 256  
 kiji 119, 276, 293  
 kikagaku 165  
 kikai 187  
 kikaikōzō 202  
 kikan 18  
 kikan shitsu 214  
 kiken 195, 322  
 kikkubokushingu 236  
 kiku 110  
 kikuimo 125  
 kimi 157  
 kimon 247  
 kimono 35  
 kimpōge 297  
 kin 235, 289  
 kin'en 322  
 kin'en seki 152, 323  
 kin'yōbi 306  
 kin'yū 97  
 kin'yū adobaizā 97  
 kinembi 26  
 kinenhi 261  
 kingaku 96  
 kingu 272, 273  
 kingyo 294  
 kinkan 126  
 kinkan gakkī 257  
 kinkyū chiryō-shitsu 48  
 kinkyū denwa 195  
 kinkyū sābisu 94  
 kinkyūjitai 46  
 kinniku 16  
 kinō 306, 320  
 kinoa 130  
 kinri 96  
 kinsei 280  
 kinsen 97  
 kinshi 51  
 kinte surippu 173  
 kinteki 273  
 kintoki mame 131  
 kinu 277  
 kinzoku 79, 289  
 kinzoku-yō bitto 80  
 kion 286  
 kīpaddo 97, 99  
 kippu 209  
 kippu uriba 209, 216  
 kipurosu 318  
 kirei na 321  
 kiri 287  
 kirieda 91  
 kirifuku 89, 311  
 kirigisutan 318  
 kirikizu 46  
 kirimi 119, 121  
 kirin 291  
 kiroguramu 310  
 kiroku 234  
 kiroku o yaburu 234  
 kiromētoru 310  
 kiru 67, 79, 273, 277  
 kiru 214  
 kirutingu 277  
 kiruto 71  
 kisetsu 307  
 kisetsu mono 129  
 kishō 286  
 kishu 210, 242  
 kisu-gawa 180  
 kissuisen 214  
 kita 312  
 kita chōsen 318  
 kita hankyū 283  
 kita kaikisen 283  
 kitai 210  
 kitana 321  
 kitchin 152  
 kitsuen 112  
 kitsuen seki 152  
 kitsune 290  
 kitsune-no-tebukuro 297  
 kitsutsuki 292  
 kitte 98, 112  
 kitte shūshū 273  
 kiwi 128  
 kiza 242  
 kizami-tabako 112  
 kizetsu suru 25  
 kizu 46  
 kizuchi 275  
 ko-azarashi 290  
 ko-uma 185  
 ko-ushi 185  
 kō'unki 182  
 koara 291  
 kōbo 138  
 kobu 291  
 kōbu doa 198  
 kōbu zaseki 200  
 kōbu zaseki 204  
 kobushi 15, 237  
 kobuta 185  
 kōcha 144, 149, 156  
 kochira ga ue 98  
 kōchō 217  
 kōchō sensei 163  
 kodachitomato 128  
 kodara 120  
 kōdo 211  
 kōdō 169  
 kodomo 23, 31  
 kodomo fuku 30  
 kodomo no ie 75  
 kodomo yōhin uriba 104  
 kodomobeya 74  
 kōdoresu denwa 99  
 koeda 296  
 kōen 262  
 kōenshō-zai 109  
 kōfun suru 25  
 kōgai 19, 299  
 kōgaku 169  
 kogamo 185  
 kōgeki 220  
 kogite 241  
 kogitte 96  
 kogitte-chō 96  
 kogu 206, 207, 241  
 kōgu sashi 186  
 kōgu-dana 78  
 kōgyōdanchi 299  
 kōhaikin 16  
 kōhan-bi 180  
 kōhi 144, 148, 153, 156, 184  
 kōhi mēka 148, 150  
 kōhi mirukusēki 149  
 kōhi supūn 153  
 kōhi tēburu 62  
 kōhi-fun 144  
 kōhi-mame 144  
 kōhikappu 65  
 kohitsujī 185  
 koi 294  
 koin randorī 115  
 koinu 290  
 kōji gamba 186  
 kōjō 299  
 kōjōsen 18  
 kōka 97  
 kōka dōro 194  
 kōka na 321  
 kōka-shiki kōshū-denwa 99  
 kōkai 313  
 kokan 12  
 kōkanshu 99  
 kokka 315  
 kokkai 313  
 kokkaku 17  
 koko 320  
 kōkō suru 240  
 kokoa paudā 148  
 kōkoku 315  
 kokonattsu 129  
 kokotto 69  
 kōkū bokan 215  
 kokuban 162  
 kōkūbin 98  
 kokuen 289  
 kōkūken 213  
 kōkūki 210  
 kokunai bin 212  
 kokuritsu kōen 261  
 kokuru 130  
 kokuryū 130  
 kokusai bin 212  
 kokuso 94  
 kokuyōseki 288  
 kokyaku sābisu bu 175  
 kōkyōkyoku 256  
 kokyū 47  
 kōkyūki kei 19  
 koma 272  
 kōmaku-gai masui 52  
 komamono 105  
 komāsharu 269  
 kombain 182  
 kombanwa 322  
 kome 130, 184  
 komedi 255  
 komekami 14  
 komezu 135  
 kōmi abura 134  
 kōmi shefu 152

- komichi 58, 85  
 kōmori 290  
 komoro 317  
 kompakuto 40  
 kompakuto disuku 269  
 kompakuto kā 199  
 kompakuto mirā 40  
 kompasu 165, 240, 312  
 kompyūta 176  
 komugi 130, 184  
 komugiko 138  
 komuragaeri 239  
 komyunikēshon 98  
 kōn yu 135  
 kon'yakusha 24  
 kon'yakusha 24  
 kona chizu 136  
 kōnā furaggu 223  
 kōnā kikkū 223  
 kona-gusuri 109  
 kondishonā 38  
 kondōmu 21  
 koneko 290  
 koneru 138  
 kongo 317  
 kongo minshu kyōwakoku 317  
 kōnisu 300  
 konkōsu 209  
 konkurito burokku 187  
 konkurito mikisā 186  
 konnichiwa 322  
 kōnotori 292  
 konran suru 25  
 konro 67  
 konsāto 258  
 konsento 60  
 konshirā 40  
 konshū 307  
 konsome 158  
 konsōru 269  
 kontakutorenzu 51  
 kontena 216  
 kontena-sen 215  
 kontenakō 216  
 kontora fagotto 257  
 kontorabasu 256  
 kontorōrā 269  
 koppu rui 65  
 kōra 144, 293  
 korāju 275  
 korekuto kōru 99  
 kōri 120, 287  
 kōri nashi 151  
 kōri to remon 151  
 kōri-basami 150  
 kōri-iri 151  
 koriandā 133  
 kōrin 197  
 kōrogi 295  
 korombia 315  
 kōrudopuresu yu 135  
 koruku sen 134  
 koruku sennuki 150  
 kōrurabi 123  
 konusetto 35  
 korushika 316  
 kōryū denyū 60  
 kōsai 51  
 kōsaku nōjō 183  
 kōsaten 298  
 kōseki 289  
 koshi 12, 169  
 kōshi niku 118  
 kōshinyō 132  
 koshitsu 48  
 koshō 64, 152, 203  
 koshō no mi 132  
 koshōchū 322  
 kōshū-denwa bokkusu 39  
 kosobo 316  
 kōsoku bōto 241  
 kōsoku dōro 194, 323  
 kōsoku mōtābōto 214  
 kōsoku ressha 208  
 kossetsu 46  
 kōsu ryōri 153  
 kōsui 41  
 kōsui uriba 105  
 kosuritoru 77  
 kosuru 77  
 kōsutā 150  
 kosutarika 314  
 kotae 163  
 kotaeru 163  
 kōtaku 271  
 kote 187  
 kotēji gāden 84  
 kōto 32, 226, 227  
 kōtō 19  
 kōtōgai 19  
 kōtojibowāru 317  
 kōtsū 192, 194  
 kōtsū jūnsa 195  
 kōtsū jūtai 195  
 kotsuban 17,  
 kotsufun 88  
 kotton bōru 41  
 kottōya 114  
 kowagaru 25  
 kōwan 214, 216  
 kowaremono 98  
 koyagi 185  
 koyōnushi 24  
 koyubi 15  
 kōza bangō 96  
 kōzai 79  
 kōzan shokubutsu 87  
 kozara 65  
 kōzui 287  
 kozutsumi 99  
 ku/kyū 308  
 kubaru 273  
 kubi 12  
 kubisujji 13  
 kuchi 14  
 kuchibashi 293  
 kuchibeni 40  
 kuchibiru 14  
 kudamono 107, 126, 128  
 kudamono jūsu 156  
 kudamono kago 126  
 kudōjiku 202  
 kūfuku 64  
 kugatsu 306  
 kugi 80  
 kui 90  
 kuiki 299  
 kuin 272, 273  
 kujaku 293  
 kujakuseki 289  
 kujira 290  
 kuki 111, 122, 297  
 kūki ni sarasu 91  
 kūki-doriru 187  
 kūki're 207  
 kukki 113  
 kūkō 212  
 kuma 291  
 kumade 88  
 kumin 132  
 kumo 287, 295  
 kumori 286  
 kuni 315  
 kunsei 118, 121, 143, 159  
 kunsei nishin 157  
 kuōto 311  
 kura 242  
 kurabu 273  
 kurabu-sando 155  
 kurabuhaisu 232  
 kurage 295  
 kurai 321  
 kuraianto 180  
 kurakushon 201, 204  
 kurampu 78, 166  
 kuranberī 127  
 kurarinetto 257  
 kurashikku kā 199  
 kurashikku ongaku 255  
 kurasshikku 259  
 kurasupu 36  
 kuratchi 200, 204  
 kurejitto kādo 96  
 kurementin 126  
 kurēn 216  
 kurēn-sha 187  
 kurenzā 41  
 kurēpu 155  
 kureson 123  
 kuri 129  
 kuriketto 225  
 kuriketto bōru 225  
 kuriketto senshu 225  
 kurīmu 109, 140, 157  
 kurīmu chizu 136  
 kurīmu hachimitsu 134  
 kurīmu pai 141  
 kūrīngu raku 69  
 kurīningu-ya 115  
 kurippubōdo 173  
 kurīsu 225  
 kurisumasu 27  
 kurisupu bureddo 139, 156  
 kurīto 240  
 kuritorisu 20  
 kuro 272, 274, 321  
 kuro komugiko 138  
 kuro obi 237  
 kuro oribu 143  
 kuro pan 139, 149  
 kuroachia 316  
 kurōbā 297  
 kurobīru 145  
 kurōbu 133  
 kurokami 39  
 kurokodairu 293  
 kurome mame 131  
 kurōru 239  
 kurosu torēnā 250  
 kurosu-kantorī 247  
 kurosubā 222  
 kurowassan 156  
 kurubushi-take 34  
 kurumaebi 121  
 kurumaisu 48  
 kurumaisu taiō 197  
 kurumi 129  
 kurumi abura 134  
 kusa 87  
 kusachi 285  
 kusatta 127  
 kushami 44  
 kushi 38, 68  
 kushi de suku 38  
 kussakuki 187  
 kushon 62  
 kusukusu 130  
 kusurijubi 15  
 kutsu 34, 37  
 kutsu uriba 104  
 kutsuhimo 37  
 kutsuhimo ana 37  
 kutsushita 33  
 kutsuya 114  
 kutsuzoko 37  
 kuwa 88  
 kuwēto 318  
 kyabetsu 123  
 kyabin 210  
 kyadi 233  
 kyaku 38, 64, 96, 104, 106, 152  
 yakusha 208  
 yakushitsu 100, 209  
 yakushitsu-zuki basurūmu  
 100  
 yambasu 274  
 yamisōru 35  
 yampasu 168  
 yampingu kā 266  
 yampingu torērā 266  
 yampu 266  
 yampu beddo 266  
 yampu suru 266  
 yampufaiyā 266  
 yampujō 266  
 yappu 21  
 yarameru 113  
 yarawei shido 131  
 yaria 204  
 yarikotto 75  
 yaserōru nabe 69  
 yatatsu 82  
 yatchā 229  
 kyō 306  
 kyōdai 22  
 kyōfū 286  
 kyōgi 243, 247  
 kyōgijō 223  
 kyōkai 299, 300  
 kyōkaku 17  
 kyōkasho 163  
 kyōkin 16  
 kyōkotsu 17  
 kyokuchi 282  
 kyokusen 165  
 kyori 310  
 kyōrikiko 139  
 kyōshi 190  
 kyōshitsu 162  
 kyōsō 234  
 kyōsōba 243  
 kyōtsui 17  
 kyū 164  
 kyū banme 309  
 kyūba 314  
 kusa 87  
 kyūba ribure 151  
 kyūyaku 308  
 kyūin kappu 81  
 kyūji suru 64  
 kyūji-yō supūn 68  
 kyūjō 228  
 kyūjō-in 239  
 kyūjū 308  
 kyūjū banme 309  
 kyūka 212  
 kyūkei jikan 254  
 kyūki sōchi 199  
 kyūkon shokubutsu 86  
 kyūkyū iryō tai'in 94  
 kyūkyū sosei 47  
 kyūkyūbako 47  
 kyūkyūsha 94  
 kyūmei bōto 240  
 kyūmei bui 240  
 kyūmei dōi 240  
 kyūmeitei 214  
 kyūnyūki 44, 109  
 kyūri 125  
 kyūryō 175, 284  
 kyūryū 241, 284  
 kyūseki 261  
 kyūshi 50  
 kyūshi torei 172  
 kyūshifu 256  
 kyūsui-kō 61  
 kyūsuiikan 61  
 kyūyūjō 199  
**M**  
 mabuta 51  
 machiai-shitsu 45  
 machibari 276  
 machikado 298  
 madagasukaru 317  
 made 320  
 made ni 320  
 mado 58, 186, 197, 210  
 madoguchi 96, 98  
 madorā 150  
 mafin 140  
 mafin-gata 69  
 mafurā 31, 203, 204  
 māgarin 137  
 mago 23



- mago musuko 22  
 mago musume 22  
 magu kappu 65  
 maguma 283  
 magumadamari 283  
 maguneshiumu 109  
 maguro 120  
 magusa 186  
 mahöbin 267  
 maiku 179, 258  
 maikuro basu 197  
 maikuroraito 211  
 mainasu 60, 165  
 mairu 310  
 maishü 307  
 maitä bokkusu 81  
 maitoshi 307  
 maitzuki 307  
 majipan 141  
 majoramu 133  
 makademianattsu 129  
 makedonia 316  
 makeru 273  
 makijaku 80  
 makimodoshi 269  
 maku 67, 254  
 mäku suru 227  
 makura 70  
 makurakabä 71  
 makurame 277  
 mama chichi 23  
 mama haha 23  
 mama musuko 23  
 mama musume 23  
 mämarëdo 134, 156  
 mamerui 130, 131  
 mampuku 64  
 manabu 163  
 manaita 68  
 manchego chizu 142  
 manëjä 24, 174  
 manga-bon 112  
 mangetsu 280  
 mangö 128  
 manhöru 299  
 manikyua 41  
 manriki 78  
 manshon 59, 298  
 manshon-tö 59  
 mantoru 282  
 mantorupisu 63  
 manyuaru 200  
 marakasu 257  
 marason 234  
 marawi 317  
 mare ni 320  
 marëshia 318  
 mari 317  
 marina 217  
 marine 143, 159  
 maruchi bitamin 109  
 marugoto 129, 132  
 marui kogata pan 140  
 marukubi 33  
 marumero 128  
 marunoko 78  
 maruta 316
- maruyane 300  
 mashin-gan 189  
 mashita 320  
 mashumaro 113  
 massäji 54  
 masshurümu 125  
 massugu 260  
 masu 120  
 masui-shi 48  
 masukara 40  
 masukingu tëpu 83  
 masuku 189, 228, 239, 249  
 masume 272  
 masutädo 155  
 masuto 240  
 matchi 112, 230  
 mategai 121  
 matenö 299, 300  
 matïni 151  
 mato 249  
 matsu 296  
 matsu no mi 129  
 matsuge 14, 51  
 matsuri 27  
 matto 54, 235, 267  
 mattoreso 70, 74  
 maue 320  
 maunten baiku 206  
 mausu 176  
 mausu pisu 237  
 mausu wosshu 72  
 mayonaka 305  
 mayonëzu 135  
 mayu 295  
 mayuge 14, 51  
 mazeru 67, 138  
 me 14, 51  
 medama kurippu 173  
 medamayaki 157  
 medaru 235  
 megane 51  
 megane-ten 51  
 megane-ya 189  
 mei 23  
 meiösei 280  
 meirei 180  
 meisho 261  
 meisö 54  
 mejä 276  
 mejä kappu 150  
 mekjäki 120, 294  
 mekishiko 314  
 mekyabetsu 123  
 mëkyappu 40  
 memo 175, 191  
 memori 176  
 memori kädo 271  
 men 158, 164, 236, 277  
 menka 184  
 menkai jikan 48  
 menö 289  
 menseki 165, 310  
 menyü 148, 153, 154  
 menyübä 177  
 menzeiten 213  
 mëpuru shiropo 134  
 merange 140
- merodï 259  
 meron 127  
 mëru adoresu 177  
 mëru akaunto 177  
 messëji 100  
 messhu käten 63  
 mesu 167  
 mësu 132  
 mëtoru 310  
 meushi 185  
 mezamashi o kakeru 71  
 mezamashi-dokei 70  
 mezameru 71  
 mi 122, 296  
 michi annai 323  
 michita 321  
 midori 274  
 midori oribu 143  
 migaku 77  
 migi 260  
 migi desu 323  
 migi handoru 201  
 mijikai 32  
 mijukuji 52  
 mikazuki 280  
 mikessai-bako 172  
 miki 296  
 mikisä 66  
 mikishingu böru 66, 69  
 mikkusu sarada 158  
 mimi 14, 139  
 mimizu 295  
 minami 312  
 minami afurika 317  
 minami hankyü 283  
 minami kaikisen 283  
 minato 217  
 mineraru wötä 144  
 mini disuku reködä 268  
 minibä 101  
 minikui 321  
 minto ti 149  
 mippü bin 135  
 miriguramu 310  
 mirimëtoru 310  
 miririttoru 311  
 miruku 136  
 miruku chokorëto 113  
 miruku köhi 148  
 miruku ti 149  
 mirukusëki 137, 149  
 misairu 211  
 mishin 276  
 mitöbörü 158  
 miton 30  
 mitopai 158  
 mitsuami 39  
 mitsubachi 295  
 mitto 228  
 mitto 236  
 miyagemono 260  
 mizambiku 317  
 mizore 286  
 mizu 144, 238  
 mizu jetto 95  
 mizu o hiku 183  
 mizu o yaru 90
- mizu'umi 285  
 mizuabi püru 263  
 mizubukure 46  
 mizugi 238, 265  
 mizuhane böshi-ban 66  
 mizukiri zaru 68  
 mizukiridai 67  
 mizukusa 86  
 mizumizushi 127  
 mizusashi 65, 151  
 mizuyari 89  
 möbiru 74  
 mochikaeri 154  
 möchö 18  
 modemu 176  
 moderu 169  
 möfu 71, 74  
 mokei 190  
 mokei seisaku 275  
 mokkan gakkï 257  
 mokkö 275  
 mokkö-yö doriru bitto 80  
 mokkö-yö setchakuzai 78  
 mökon 39  
 mokusei 280  
 mokusei supün 68  
 mokutan 275  
 mokutekichi 213  
 mokuyöbi 306  
 mokuzai 79, 275  
 mokuzai chakushokuzai 79  
 mömaku 51  
 momo 126, 128  
 momoniku 119  
 mon 85, 182  
 monako 316  
 mondai 271  
 mongöika 121  
 mongoru 318  
 monitä 53, 172, 176  
 monohoshi-yö röpu 76  
 monoporï 272  
 monorëru 208  
 monsün 287  
 montäju shashin 181  
 montenegro 316  
 moppu 77  
 mörishasu 317  
 möritania 317  
 morokko 317  
 morudibu 318  
 mörudingu 63  
 morudoba 316  
 morutaru 187  
 moruto su 135  
 moshimoshi 322  
 möshitate 94  
 mosuku 300  
 mötä 88  
 motokurosu 249  
 motsarera chizu 142  
 motto warui 321  
 moya 287  
 moyashi 122  
 moyö sentaku 276  
 mu-shhibö 137  
 muchiuchishö 46
- muen 137, 199  
 mujitsu 181  
 mukade 295  
 mukiebi 120  
 muko 22  
 mukötaku 271  
 munabire 294  
 mune 12  
 muneniku 119  
 münsutön 288  
 mura 299  
 murasaki 274  
 murasaki igai 295  
 mure 183  
 mürugai 121  
 musekitsuï döbutsu 295  
 musen-yö antena 214  
 mushi-sasare 46  
 mushiba 50  
 mushita 159  
 mushiyoke 108, 267  
 musu 67  
 müsu 141  
 musuko 22  
 musume 22  
 muzai 181  
 muzukashi 321  
 myakuhaku 47  
 myüjïkaru 255
- N**  
 nadare 247  
 nae 91  
 nafuda 189  
 nagagutsu 31  
 nagai 32  
 nagasa 165, 310  
 nagashi 66  
 nagashidai 61, 72  
 nage 237  
 nageru 221, 227, 229, 245  
 naibumpi kei 19  
 naibumpi-ka 49  
 naifu 65  
 naijeria 317  
 naikaku 282  
 nairon 277  
 naisö 200  
 naisö köji 82  
 naisö köji shokunin 82  
 naito 272  
 naitogaun 31, 32, 35  
 naiya 228  
 naizö 18, 118  
 naizö furasshu 270  
 naka 320  
 nakaniwa 58, 84  
 nakayubi 15  
 naku 25  
 nama 124, 129  
 nama chizu 136  
 nama kuriimu 137  
 namaniku 142  
 nambä purëto 198  
 nambei 315  
 namekuji 295  
 nami 241, 264

namiashi 243  
 namibia 317  
 namida 51  
 namigata 139  
 nan 139  
 nan'yō 313  
 nana 308  
 nana banme 309  
 nanahyaku 308  
 nanajū 308  
 nanajū banme 309  
 nankō 47, 109  
 nankotsu 17  
 nanzai 79  
 napukin 65, 152  
 napukin ringu 65  
 nashi de 320  
 nasu 125  
 natane 184  
 natane abura 135  
 natauri 124  
 natsu 31, 307  
 natsume 129  
 natsumeggu 132  
 natto 80  
 nattsu 129, 151  
 nawatobi 251  
 naya 85  
 naya 182  
 ne 50, 124, 296  
 nebukuro 267  
 nedan 152  
 nega 271  
 negurije 31, 35  
 neji 80  
 nekku 258  
 nekkurain 34  
 nekkuresu 36  
 neko 290  
 nekutai 32  
 nekutaipin 36  
 nekutarin 126  
 nemaki 31  
 nembangan 288  
 nendo 85, 275  
 nenryō tanku 104  
 nenryōkei 201  
 nenryōtanku 203  
 nenza 46  
 neōi suru 91  
 nepāru 318  
 neru 71  
 netsu 44  
 netsuken 286  
 netsukikyū 211  
 nettai 283  
 nettai kajitsu 129  
 netto 222, 227, 231  
 nettowāku 176  
 nezumi 290  
 ni 308  
 ni banme 309  
 ni mukatte 320  
 ni sotte 320  
 ni-ji 304  
 nichibotsu 305  
 nichiyōbi 306

nīdorū penchi 80  
 nīdorūpointo 277  
 nigai 124  
 nigatsu 306  
 nihon 318  
 nihyaku 308  
 nijēru 317  
 nijī 287  
 nijimasu 120  
 nijū 308  
 nijū banme 309  
 nijūichi 308  
 nijūichi banme 309  
 nijūni 308  
 nijūni banme 309  
 nijuppun 304  
 nijūsan banme 309  
 nikai 104  
 nikai seki 254  
 nikaidate basu 196  
 nikaragua 314  
 nikkeru 289  
 nikkyōyoku o suru 264  
 nikomu 67  
 nikonda 159  
 niku 107, 118  
 niku fukku 118  
 nikukiribōchō 68  
 nikutataki 68  
 nikuya 114, 118, 188  
 niman 309  
 nimotsu 100, 198, 213  
 nimotsu hikiwatashi 213  
 nimotsuure 210  
 nin 129  
 ninensō 86  
 ningen kankei 24  
 ningyō 75  
 ninjin 124  
 ninniku 125, 132  
 ninshin 52  
 ninshin dekiru 20  
 ninshin shiteiru 52  
 ninshin suru 20  
 ninshin tesuto 52  
 niranegi 125  
 nire 296  
 nisen nen 307  
 nishi 312  
 nishi sahara 317  
 nishoku-tsuki 101  
 nishūkan 307  
 nisu 79, 83  
 nitchū 305  
 nitōkin 16  
 niwa 84  
 niwa no akusento 84  
 niwa no shokubutsu 86  
 niwa no yōshiki 84  
 niwashi 188  
 niwatori 185  
 no aida 320  
 no jōhō 320  
 no kahō 320  
 no mae 320  
 no mukaigawa 320  
 no mukō 320

no naka e 320  
 no soba 320  
 no ue 320  
 no ue e 320  
 no ushiro 320  
 nobasu 251  
 nochi 304  
 nōchi 182  
 nochihodo 320  
 nodo 19  
 nodo ame 109  
 nodobotoke 19  
 nōfu 182, 189  
 nōjō 182  
 nōka 182  
 nōka no niwa 182  
 noki 58  
 nokku auto 237  
 nokogiri-ba 78  
 nomi 81  
 nomimono 107, 144, 156  
 nori 275  
 nori-zuke dai 82  
 noribake 82  
 norikaeru 209  
 norikumi'in 241  
 noritsugi 212  
 noruwē 316  
 noshibō 69  
 nōshintō 46  
 nōsotchū 44  
 nōsurību 34  
 nōto 163, 172, 173  
 nōto o toru 163  
 nōtopasokon 175, 176  
 nozuru 89  
 nu'u 277  
 nugā 113  
 nuigurumi 75  
 nuime 34, 277  
 nunoji 277  
 nyō kan 21  
 nyōdō 20  
 nyūbachi 167  
 nyūbō 167  
 nyūeki 41  
 nyūgaku jimukyoku 168  
 nyūgaku suru 26  
 nyūin 48  
 nyūji 23  
 nyūjirando 319  
 nyūjō muryō 322  
 nyūjō-ryō 260  
 nyūkin suru 96  
 nyūkin-sho 96  
 nyūkoku shinsa 213  
 nyūseiin 107, 136  
 nyūsu 178  
 nyūsukyasutā 179, 191  
 nyūtō 137  
 nyūtoraru zōn 224

○  
 o 121, 242, 280, 290, 292, 294  
 o mawatte 320  
 o tōtte 320  
 o yokogitte 320

o-susume ryōri 152  
 o-tearai 104  
 o-tsumami 151  
 o-ushi 185  
 oba 22  
 ōbā pā 233  
 ōbāfurō kan 61  
 ōbāheddo purojekutā 163  
 ōbāōru 30  
 obi 236  
 obikiyoseru 245  
 ōboe 257  
 oboreru 239  
 ōbun 66  
 ōbunmitto 69  
 ōdan hodō 195  
 odango 39  
 ōdio shisutemu 268  
 odomētā 201  
 ōdōri 299  
 odoriba 59  
 odoroku 25  
 ōdotoware 41  
 ofisu 24  
 ofisu biru 298  
 ofu saido 223  
 ōfuku bunri dōro 195  
 ōhanmā 187  
 ohayō gozaimasu 322  
 ohyō no kirimi 120  
 oi 23  
 oikoshi shasen 194  
 oikosu 195  
 oiru 199  
 oiru gēji 202  
 oiru tanku 204  
 oita 321  
 oiwai 27, 140  
 oiwai-yō kēki 141  
 oji 22  
 ōkakumaku 19  
 ōkami 290  
 okan 44  
 ōkē 322  
 ōkesutora 254, 256  
 ōkesutora pitto 254  
 ōkī 321  
 okiru 71  
 okoru 25  
 okosama menyū 153  
 okujō teien 84  
 okura 122  
 okure 209  
 okuyuki 165  
 ōkyū teate 47  
 omān 318  
 omaru 74  
 omocha 75, 105  
 omocha kago 75  
 omoi 321  
 omori 166, 244  
 omoshiroi 321  
 ompu 256  
 ōmu 293  
 ōmugi 130, 184  
 omuretsu 158  
 omutsu 30, 75

omutsu kabā 30  
 omutsu kabure kurīmu 74  
 omutsu kae baggu 75  
 omutsu kae shīto 74  
 ondokei 167  
 ondori 185  
 ongaku 162  
 ongaku gakkō 169  
 ongaku janru 259  
 ongakuka 191  
 ongakukai 255  
 onigiri 154  
 ōningu 148  
 onkai 256  
 onna no ko 23  
 onrain 177  
 onryō 179, 269  
 onsei messeji 99  
 onshitsu 85  
 onsu 310  
 onsuī tanku 61  
 onsuī tappu 72  
 opāru 288  
 opera 255  
 ōpun kā 199  
 ōpun toppu 260  
 ōpun-sando 155  
 oranda 316  
 oregano 133  
 orenji 126  
 orenji iro 274  
 orenji jūsu 149  
 orenjiēdo 144  
 orību 151  
 orībuyu 134  
 origami 275  
 orimage genkin 98  
 ōrora 286  
 oroshigane 68  
 oroshita 121  
 ōru 241  
 ōrusupaisu 132  
 orutanēta 203  
 osae 237, 276  
 osage 39  
 oshibe 297  
 oshikomi gōtō 94  
 oshiri fuki 74  
 oshiroi 40  
 osoi 305, 320  
 osu 322  
 ōsutorarēshia 319  
 ōsutoraria 319  
 ōsutoria 316  
 otafukukaze 44  
 otama 68  
 otamajakushi 294  
 ōtobai 204  
 ōtobai rēsu 249  
 otoko no ko 23  
 ōtoma 200  
 otona 23  
 ototoi 307  
 otsuri 99  
 otto 22  
 otoretsu 158  
 owari 31  
 ōya 58

- oyasuminasai 322  
oyayubi 15  
oyogu 238  
oyoso 320  
özara 65  
ozonsö 286
- P**
- pä 233  
paddo 53, 220  
padokku 243  
padoru 241  
pafu 40  
pāgora 84  
pai 143  
pai kiji 140  
pai yaki-zara 69  
painappuru 128  
painappuru jūsu 149  
painto 311  
paipu 112  
paipu kattä 81  
pairotto 190, 211  
pajama 33  
pākingu mētä 195  
pakisutan 318  
pakku 224, 311  
pāma 39  
pan 138, 157  
pan kiji 138  
pan rui 107  
pan shokunin 139  
pan-zukuri 138  
pan'ya 114, 138  
panama 314  
panchi baggu 237  
panda 291  
pankēki 157  
panko 139  
panku 203, 207, 259  
panku shūri setto 207  
pansuto 34, 35  
panti 35  
panti rainä 108  
papaia 128  
papuanyüginia 319  
papurika 132  
paraguai 315  
paraguraidingu 248  
parashüto 248  
parashüto kōka 248  
parasoru 148  
paretto 186, 274  
parittoshita 127  
parumetto yashi no shin 122  
parumezan chīzu 142  
paseri 133  
pasokon 172  
pāsonaru torēnä 250  
passhonfurütsu 128  
pasu 226  
pasu suru 220, 221  
pāsunippu 125  
pasuta 158  
pasuteru 274  
patä 233  
patchi 207
- patchiwäku 277  
pate 142, 156  
patokä 94  
patto o utsu 233  
pauä 132  
pedaru 61, 206  
pedikyua 41  
pedimento 301  
pegu 258, 266  
pemparu 24  
pen 163  
penaruti 223  
penaruti eria 223  
penchi 80  
pendanto 36  
pengin 292  
penisu 21  
penki 83  
pensaki 163  
pēpä napukin 154  
peparoni 142  
perikan 292  
perü 315  
pessarī 21  
pesutori 140, 149  
petto fūdo 107  
petto shoppu 115  
piano 256  
pikannattsu 129  
pikkoro 257  
pikkuappu 258  
pikkunmikkusu 113  
pikunikku 263  
pikunikku benchi 266  
pikurusu 159  
pīman 124  
pimbokē 271  
pin 60, 249  
pinattsu 129, 151  
pinattsubatä 135  
pinku 274  
pinsetto 47, 167  
pinto o awaseru 271  
pipetto 167  
piratisu 251  
piru 21  
pisutachio 129  
pita pan 139  
pitchä 229  
pitchä maundo 228  
pitchi 225, 256  
piza 154, 155  
piza-ya 154  
pōchi 58  
pökä 273  
poketto 32  
pön 272  
pondo 310  
poniteru 39  
poppukön 255  
poppusu 259  
popura 296  
popuri 111  
pōrando 316  
poriesuteru 277  
porijiji 157  
poro 243
- pōru 266  
porutogaru 316  
posutä 255  
posutä karä 274  
pötä 100  
pötäburu shi-dī purēyā 268  
poteto chippusu 113, 151  
poteto masshä 68  
pöto 176  
pötoforio 97  
pötörëto 271  
pötowain 145  
puchi tomato 124  
pudingu raisu 130  
puerutoriko 314  
purachina 289  
puragu 60  
puraimä 83  
puramu 126  
purasu 60, 165  
purasu doraibä 80  
purattofōmu shūzu 37  
purē no sen 233  
purëto 283  
purēyā 268, 273  
purezentä 174  
purezentëshon 174  
purezento 27  
purin 141  
purinta 172, 176  
purodyūsä 254  
puroguramu 176, 254  
purojekutä 174  
puropera 211, 214  
purosessa 176  
puroshutto 143  
pūru 101, 238, 249, 250
- R**
- raberu 89, 172  
rabu 230  
radisshu 124  
rafu 232  
rafutingu 241  
ragubī 221  
ragubī böru 221  
ragubī senshu 221  
ragubī-gi 221  
ragubī-jō 221  
raibu 178  
raimame 122, 131  
raimu 126  
raimugi pan 138  
rain jajji 220  
raion 291  
raishū 307  
raisu pudingu 140  
raitä 112  
raito 207  
raito suitchi 201  
rajijētä 60, 202  
rajio 179, 268  
rajio kyoku 179  
rajio o tsukeru 269  
raketto 230, 231  
raketto supōtsu 231  
rakettoböru 231
- rakkasei yu 135  
raku 221  
rakuda 291  
rakunōjō 183  
rakurusu 249  
rakuyōju 86  
ramadän 27  
ramikin 69  
rampaku 137  
rampu 62, 217  
rampusutēki 119  
ramu 176  
ramu niku 118  
ramushu 145  
ran 111, 228  
ran'ō 137  
ranchon matto 64  
randosukēpu 271  
ranhō 20  
ranjeri 35, 105  
ranji 251  
rankan 20  
ranningu shatsu 251  
ranshi 20, 51  
ransō 20  
raosu 318  
raperu 32  
rappu 259  
rappu-sando 155  
rari 230, 249  
ratobia 316  
raudo supikä 268  
raundo 237  
razuberi 127  
razuberi jamu 134  
rebä 61, 118, 150  
rebä'ächi-shiki fairu 173  
rebanon 318  
rēdä 214, 281  
reddo kädō 223  
reddokaranto 127  
rege'e 259  
reggu paddo 225  
reggu puresu 251  
reginsu 31  
regyurētä 239  
rei 308  
rei ten go rittoru 311  
reijō 180  
reiki ryōhō 55  
reikyakueki tanku 202  
reinkōto 31, 32  
reishi 128  
reisui tappu 72  
reitō 121, 124  
reitō shokuhin 107  
reitō suru 67  
reitōko 67  
reitōreizōko 67  
reizōko 67  
reji 106, 150  
rejji-gakari 106  
rēki 88  
rekigan 288  
rekishi 162  
rekishi-teki kenzōbutsu 261  
rekkä idō 195
- rekōdo-ten 115  
remon 126  
remon garei 120  
remon kädō 134  
remon ti 149  
remonēdo 144  
remongurasu 133  
rēn 234, 238  
ren'ai monogatari 255  
ren'ai suru 26  
renchi 81, 203  
renga 187  
renmei 223  
rennyū 136  
renshū-jiai 237  
rentakä 213  
rentogen 48  
rentogen byuä 45  
rentogen kensa söchi 212  
rentogen shashin 50  
renzoku dorama 178  
renzu 51, 270  
renzu kēsu 51  
renzu kyappu 270  
renzumame 131  
repötä 179  
rēru 208  
rēsä 249  
reshibu suru 227  
rēshingu baiku 205  
resoto 317  
ressha 208  
restoran 101  
rēsu 35  
rēsū-yō bobin 277  
rēsuaumi 277  
resuringu 236  
resutoran 152  
retäheddo 173  
retasu 123  
retsu 210, 254  
retto 230  
ribaundo 226  
riberia 317  
ribia 317  
ribon 27, 39, 111, 141, 235  
rīdo shingä 258  
rifu ti 144  
rifurekusorojji 54  
rifurekutä 204, 207  
rifuretto 96  
rifuto 246  
rigakuryōhō-ka 49  
rigin 240  
rihitenshutain 316  
rikon 26  
riku-game 293  
rikuchi 282  
rikujō kyōgi 234  
rikujō kyōgi-sha 234  
rikyūru 145  
rimä 80  
rimokon 269  
rimpa kei 19  
rimu 206  
rimujin 199  
rinchi 285



rinden 296  
rinen 277  
ringo 126  
ringo jūsu 149  
ringo no shin nuki-ki 68  
ringo su 135  
ringoshu 145  
ringu 237  
ringu tai 89  
rinjin 24  
rinku 36  
rippōtai 164  
rippu burashi 40  
rippu gurosu 40  
rippu rainā 40  
rirakusēshon 55  
rirē kyōsō 235  
ririku suru 211  
riru 244  
risaikuru bokkusu 61  
risu 290  
risutobando 230  
ritān 231  
ritoania 316  
rittaizukei 164  
rittoru 311  
roba 185  
rōbai suru 25  
robī 100, 255  
robu 231  
rōbu 169  
robusutā 121, 295  
rodeo 243  
rōdo baiku 206  
rōdo rēsā 206  
rōganberi 127  
rogo 31  
roguon suru 177  
rōingu mashin 250  
roji 298  
rojō kafe 148  
rokata 194  
roketto sarada 123  
rokkā 239  
rokkaku-bō renchi 80  
rokkakukei 164  
rokkankin 16  
rokkī sanmyaku 312  
rokkotsu 17  
rokku 207  
rokku konsāto 258  
rokku kuraimingu 248  
rokoko 301  
roku 308  
roku banme 309  
rokuga 178, 269  
rokugatsu 306  
rokujū 308  
rokujū banme 309  
rokuon sutajio 179  
rokuro 275  
romen densha 196, 208  
romen hyōshiki 194  
rompāsu 30  
rōn 96  
roppyaku 308  
rōpu 248, 266

rōrā 83, 187  
rōrā ukezara 83  
rōrāburēdo 263  
rōrāsukēto 249  
rōrāsukēto-gutsu 249  
rōrie 133  
rōru 311  
rōru sukurin 63  
rōrupan 139, 143  
rosen bangō 196  
roshi 167  
roshia rempō 318  
roshutsu 271  
roshutsu hōsei daiyaru 270  
roshutsu-busoku 271  
roshutsu-ōbā 271  
roshutsukei 270  
rōsoku 63  
rōsuto 158  
rōsuto suru 67  
rōtā burēdo 211  
roten 154  
rōto 166  
roze (wain) 145  
rōzumari 133  
ruā 244  
rubī 288  
rūfu rakuu 198  
rūku 272  
rukusemburuku 316  
rūmania 316  
rūmu sabisu 101  
runesansu 301  
rūpin 297  
rusuban denwa 99  
rūtā 78  
rutabaga 125  
rutsubo 166  
ruwanda 317  
ryōchō 119  
ryōdo 315  
ryōgaejo 97  
ryōhōshi 55  
ryoken 213  
ryōkin 197, 209  
ryōkin-jo 194  
ryokō dairiten 114, 190  
ryokō kogitte 97  
ryokō panfuretto 212  
ryokōkaban 37  
ryokucha 149  
ryokutō 131  
ryōseirui 294  
ryōshi 189  
ryōshin 23  
ryōshūsho 152  
ryūchijō 94  
ryūju 247  
ryūkusakku 31, 37, 267  
ryūsei 280  
ryūzan 52

S

saba 120  
sābā 176  
sabaku 285  
sabisu purobaida 177

sabisu-ryō 152  
saboten 87  
sābu 231  
sābu rain 230  
sābu suru 231  
sadoru 206  
sāfā 241  
safaia 288  
safari pāku 262  
sāfin 241  
sāfubōdo 241  
safuran 132  
sagan 288  
sagefuri 82  
sagyō-sha 212  
sagyōba 78  
sagyōdai 78  
sahara sabaku 313  
sai 291  
saibai suru 91  
saibankan 180  
saibansho shokuin 180  
saido dekki 240  
saido ōdā 153  
saidorain 220, 226, 230  
saien 182  
saifu 37  
saigo 320  
saihō-bako 276  
saihosō 187  
saijōdan 141  
saikoro 272  
saikuringu 263  
saimin ryōhō 55  
sairen 94  
sairo 183  
saizei 269  
saisho 320  
saito 266  
sakago 52  
sakana 107, 120  
sakana no kunsei 143  
sakanaya 114, 120, 188  
sakaya 115  
sake 120, 152  
sakitto torēningu 251  
sakkā 222  
sakkā bōru 222  
sakkā senshu 222  
sakkā shūzu 223  
sakkā-gi 31, 222  
sakkā-jō 222  
sakkīn 47  
sakotsu 17  
saku 74, 85  
sakubun 163  
sakugu 215  
sakumotsu 183, 184  
sakunyū-ki 53  
sakurambo 126  
sakurasō 297  
sakusofon 257  
sambashi 217  
sambaddo 41  
sambyaku 308  
same 294  
sāmosutatto 61

samui 286  
san 23, 308  
san banme 309  
sandā 78  
sanderu 31, 37  
sandoitchi 155  
sandoitchi uriba 143  
sandopēpā 83  
sangai 104  
sangai seki 254  
sangatsu 306  
sangoshō 285  
sangurasu 51, 265  
sanhanki 52  
sanjū 308  
sanjū banme 309  
sanjūppun 304  
sanka 49  
sanka byōtō 48  
sanka-i 52  
sankakkei 164  
sankaku-kōn 187  
sankakufu 46  
sankakujōgi 165  
sankakukin 16  
sankō shiryō 302  
sankyaku 166, 270, 281  
sanmarino 316  
sanmyaku 282  
sanrūfu 202  
sanruishu 228  
sanshō-uo 294  
sanshoku-tsuki 101  
sansu 165  
sansukurin 108  
santōkin 16  
santome purinshipe 317  
sao 245  
sapōtā 227  
sapurimento 55  
sara 65  
sara'arai-ki 66  
sarada 149  
sarada doreshshingu 158  
sarada yu 135  
sarami 142  
sāroinsutēki 119  
saru 291  
sarudinia 316  
sarutana rēzun 129  
sasaeobō 89, 91  
sashidashinin jūsho 98  
sashimi 121  
sasori 295  
sasu 90  
sasupenshon 203, 205  
satchūzai 89, 183  
satōkibi 184  
satōzuke kudamono 129  
satsuire 37  
satsuma mikan 126  
satsumaimo 125  
saujiarabia 318  
sauna 250  
saundo enjinia 179  
saundotorakku 255  
sawā kurimu 137

sawādō bureddo 139  
saya 122  
sayoku 228  
sayōnara 322  
se no hikui 321  
se no takai 321  
sebiere 294  
sebone 17  
sēbu suru 223  
sedai 23  
sedan 199  
sēfu 228  
sei kansenshō 20  
seibi kojō 199  
seibugeki 255  
seibutsu 162  
seichō dankai 23  
seifuku 94, 189  
seigen sokudo 195  
seihatsu suru 39  
seihyōshitsu 67  
seijigaku 169  
seikatai seki 301  
seikei dōgu 275  
seikei-geka 49  
seiki 12, 307  
seikō 20  
seikotsu ryōhō 54  
seikyoku 167  
seinō 21  
seiri yōhin 108  
seiri-yō napukin 108  
seiseki 163  
seishi 20  
seishi suru 91  
seishin-ka 49  
seishoku 20  
seishokuki 20  
seishokuki kei 19  
seisō 21  
seisōken 286  
seitai 19  
seiten 286  
seito 162  
seiuchi 290  
seiun 280  
seiyōwasabi 125  
seiyu 55  
seiza 281  
sējī 133  
sekai chizu 312  
seki 44  
sekidō 283  
sekidō ginia 317  
sekidome 108  
sekieie 289  
sekika 126  
sekitan 288  
sekitei 84  
sekiyu tankā 215  
sekizai 275  
sekizai-yō doriru bitto 80  
sekkai-shitsu dojō 85  
sekkaihan 288  
sekken 73  
sekken-zara 73  
sekyuriti bitto 80

- sembankō suru 79  
sembi 240  
semento 186  
semidetatchi 58  
semihādo chīzu 136  
semisofuto chīzu 136  
semorina 130  
semotare 64, 210  
sempatsu 39  
sempūki 60  
sen 19, 72, 165, 309  
sen kyūhaku ichi nen 307  
sen kyūhaku jū nen 307  
sen kyūhaku nen 307  
sen'i 127  
sen'in 189  
senaka 13  
senaka arai burashi 73  
senaka no kubomi 13  
senbikampan 214  
senchimētōru 310  
senchō 214  
senegarū 317  
sengaiki 215  
senjō eki 51  
senkan 215  
senkyaku 216  
senkyaku-kō 216  
senkyō 214  
senmon'i 49  
senmongakkō 169  
sennenkan 307  
sennuki 68, 150  
senrei 26  
senro 209  
sensei 54, 162  
sensha 199  
senshin 230  
senshitsu 214  
senshu 214, 240, 307  
senshukēn 230  
sensō 215  
sensuikan 215  
sentā 228  
sentā sākuru 222, 224, 226  
sentābōdo 241  
sentai 214, 240  
sentakki 76  
sentaku 76  
sentaku kansōki 76  
sentaku sabisu 101  
sentaku-basami 76  
sentakukago 76  
sentakumono 76  
sentakumono ire 76  
sentan 36, 122  
sentārain 226  
sentei noko 89  
sentei suru 91  
sentei-basami 89  
sentō 300  
sentobinsento oyobi gurenadin  
  shotō 314  
sentōki 211  
sentokurisutofā nēvisu 314  
sentorushia 314  
senzai 77
- seoyogi 239  
seramikku konro 66  
sēringu 240  
serori 122  
seroriakku 124  
serotēpu 173  
sēru 241  
serubia 316  
serufu tanningu kurīmu 41  
sesshi 50  
setā 33  
setchi pin 60  
setsugan renzu 167  
setsuzoku suru 177  
setto 178, 230, 254  
setto suru 38  
shaberu 265  
shābetto 141  
shachō 175  
shadamben 61  
shahen 164  
shakkotsu 17  
shako 58  
shakuyanin 58  
shamen 284  
shampan 145  
shampū 38  
shampū dai 38  
shāpu 256  
shārē 166  
sharin 198  
sharin-tsuki tanka 48  
shasei kan 21  
shashi 203  
shashin 270, 271  
shashin hantei 234  
shashin satsuei 271  
shashin-yō gakubuchi 271  
shashinka 191  
shasō 209  
shatai 202  
shatoru 231  
shatoru basu 197  
shattā 270  
shattā sokudo tsumami 270  
shawā 72  
shawā doa 72  
shawā jeru 73  
shawā kâten 72  
shawā o abiru 72  
shawā tō 266  
shawāheddo 72  
shefu 152, 190  
shefu no bōshi 190  
shēkā 150  
sherī 145  
shī-dī purēyā 268  
shi 308  
shiai 237  
shiatsu 54  
shiatsu ryōhō 55  
shiba de ōu 90  
shibafu 85, 90, 262  
shibakariki suru 90  
shibakariki 88, 90  
shiberia 313  
shibori bukuro 69
- shichaku shitsu 104  
shichi 308  
shichigatsu 306  
shichijū 308  
shichimenchō 119, 185, 293  
shichiria 316  
shichōsha 299  
shichū 158  
shida 86  
shierareone 317  
shifuto rebā 207  
shigai 298  
shigaisen 286  
shigatsu 306  
shigoto 170  
shihari 96  
shiharau 153  
shihēi 97  
shijōkaijatsū bu 175  
shijū 308  
shika 291  
shika kenshin 50  
shika niku 118  
shika rentogen 50  
shika yunitto 50  
shikai-sha 178  
shikakkei 164  
shikame-zura 25  
shikan 50  
shiken 163  
shikenkan 166  
shikenkan-tate 166  
shiki dai 256  
shiki'ishi 85  
shikibetsu bando 53  
shikibō 256  
shikiri kado 173  
shikisha 256  
shikke no ōi 286  
shikkui 83  
shikkui o nuru 82  
shikō 50  
shikyū 20, 52  
shikyū keibu kakuchō 52  
shikyūkei 20  
shima 282  
shima hōzuki 128  
shimai 22  
shimamenō 289  
shimatta 321  
shimauma 291  
shimbaru 257  
shimbun 112, 178  
shimbun hambaiten 112  
shimetta 321  
shimo 287  
shimon 94  
shimpai suru 25  
shimpan 222, 226, 227, 229, 230  
shin 122, 127, 173  
shin kyabetsu 123  
shin'yōju 86  
shinagōgu 300  
shinai 236  
shinamon 133  
shinchō-kei 45  
shindai koshitsu 209
- shindo 91  
shingapōru 318  
shingetsu 280  
shingō 194, 209  
shingu 74  
shingu taoru rui 105  
shinguru 151  
shinguru beddo 71  
shinguru kurīmu 137  
shinguru rūmu 100  
shingurusu 230  
shinjaga 124  
shinju no kubikazari 36  
shinkai-zuri 245  
shinkansen 209  
shinkei 19, 50  
shinkei kei 19  
shinkei-ka 49  
shinkotenshugi 301  
shinkū kappu 53  
shinkuronaizudo suimingu 239  
shinnyū kinshi 195, 323  
shinri ryōhō 55  
shinrin 285  
shinrui 23  
shinryō-shitsu 45  
shinryōjo 48  
shinsatsu 45  
shinseiji 53  
shinsen 121, 127  
shinshi fuku 105  
shinshitsu 70  
shintaiishō 235  
shintaiishōgaisa-yō chūsha  
  supēsu 195  
shinu 26  
shinzō 18, 119  
shinzōbyō-ka 49  
shinzōhossa 44  
shio 64, 129, 152  
shio-furi 121  
shio-iri 137  
shioaji 155  
shiomizu-zuke 143  
shiozuke 143  
shirā 83  
shirakaba 296  
shiretsu kyōsei burijji 50  
shiri 13  
shiria 318  
shiriaru 156  
shiriaru shokuhin 107, 130  
shirindā heddo 202  
shirizu bangumi 178  
shiro 145, 272, 274, 300, 321  
shiro komugiko 138  
shiro pan 139  
shiroari 295  
shiroari niku 118  
shiroppu 109  
shiroppu-zuke 159  
shirudo 88  
shiryō dai 167  
shiryoku 51  
shiryoku kensa 51  
shisha 175  
shishinkei 51
- shisho 168, 190  
shishū 277  
shisō 263  
shisshin suru 44  
shisutemu 176  
shisutemu techō 173  
shita 19  
shita e 320  
shitagi 32  
shitagoshirae shita tori 119  
shitake 124  
shitānuri 83  
shitateya 115, 191  
shitchi 285  
shitenchō 96  
shīto 204, 241  
shīto beruto 198, 211  
shīto pirā 206  
shītsu 71, 74  
shitsugaikotsu 17  
shitsumon 163  
shitsumon suru 163  
shiwa 15  
shiwa tori 41  
shiyō kigen 109  
shiyō-chū 321  
shizen ryōhō 55  
shizuka na 321  
shoberu 88  
shōbōsha 95  
shōbōshi 95, 189  
shōbōsho 95  
shōbōtai 95  
shōchō 18  
shōdoku eki 47, 51  
shōdoku waipu 47  
shōga 125, 133  
shōgai hietsu 243  
shōgai kyōsō 243  
shōgaibutsu 243  
shōgakuhi 169  
shōgatsu 27  
shōgeki o ukeru 25  
shōgo 305  
shohōsen 45  
shoka 168  
shōkai 49  
shōkaki 95  
shōkaki kei 19  
shōkasen 95  
shōken torihiki-jo 97  
shokkaku 295  
shokki 64  
shokki rui 65  
shokkidana 62  
shokku 47  
shōko 181  
shoku 280  
shokubutsu 296  
shokudō 19  
shokudō-sha 209  
shokugyō 188, 190  
shokuhin uriba 105  
shokujū 64, 75, 158  
shokuminchi 315  
shokumu 92  
shokupan no katamari 139

- shokuryōhin 106  
shokuryōhin-ten 114  
shokuyō abura 134  
shokuzenshu 153  
shōkyūshi 50  
shomei 96, 98  
shōmei 178  
shōmei kigu 105  
shōmeidan 240  
shōmen genkan 58  
shōni byōtō 48  
shōni-ka 49  
shonichi 254  
shōnin 180  
shoppingu sentā 104  
shorudā paddo 35, 224  
shorudābaggu 37  
shosai 63  
shōsetsu 256  
shōsha 273  
shōten 298  
shōten chōsetsu nobu 167  
shōtō 300  
shōtorihiki 175  
shōwakusei 280  
shōyu 135  
shōzō 260  
shū 306, 315  
shū-gawa 140  
shubi suru 225  
shūchū chiryō-shitsu 48  
shuhan 240  
shūhasū 179  
shūho 243  
shūjitsu 306  
shujutsu 48  
shujutsu-shitsu 48  
shūka 98  
shūkaku suru 91  
shukketsu 46  
shukkin irai-sho 96  
shukkō suru 217  
shukudai 163  
shukuhaku kyaku 100  
shukuhaku-sha meibo 100  
shukushō suru 172  
shūmatsu 306  
shuppatsu bin 213  
shuppatsu robī 213  
shūrikō 188, 203  
shusai 153  
shūshi gō 169  
shūshoku suru 26  
shūsō baggu 88  
shus-san 53  
shus-san mae 52  
shus-san suru 26  
shussei shōmeisho 26  
shussei-ji taijū 53  
shussei suru 174  
shussui-kō 61  
shutchō 175  
shuto 315  
shūto suru 223, 227  
shutō uchi 237  
shutsunyū dōro 216  
shutsunyū-ro 194
- shutsunyūkoku kanri 212  
sobakasu 15  
sobo 22  
sōbōkin 16  
sobyō 275  
sōda pan 139  
sōdasui 144  
sode 34, 254  
sodeguchi 32  
sofa 62  
sofa beddo 63  
sofu 22  
sofubo 23  
sofuto 176  
sofuto chizu 136  
sofuto dorinku 144, 154  
sōgankyō 281  
sōgen 285  
sōji 77  
sōji dōgu 77  
sōji sabisu 101  
sōjifu 188  
sōjiki 77, 188  
sōjū shitsu 210  
soketto 80  
soketto renchi 80  
sokki-sha 181  
sōko 216  
sōkō shasen 194  
sokudokei 201, 204  
sokutei 165  
sokuten 235  
sōkyū suru 223  
somnia 317  
sonata 256  
sonota no mise 114  
soramame 122, 313  
sori suberi 247  
soromon shotō 319  
sōsakei 201, 204  
sōsēji 118, 155, 157  
sōshiki 26  
sōshin suru 177  
sōshingu 36  
soshō anken 180  
sosogu 67  
sōsu 135, 143, 155  
soto 320  
sotogawa 320  
sotsugyō suru 26  
sotsugyō-rombun 169  
sotsugyō-shiki 169  
sotsugyō-shōsho 169  
sotsugyōsei 169  
su 135, 142  
suberidai 263  
suburi 233  
suchiru ūru 81  
suchuwādesu 190  
sūdan 317  
suettopantsu 33  
sufure 158  
sūgaku 162, 164  
sūgaku yōhin 165  
sugikoshimatsuri 27  
suichi ryōhō 55  
suichoku-anteiban 210
- suichokusen 165  
suichiyoku-sen 215  
suidōsui 144  
suiiei 238  
suiiei senshu 238  
suiiei yōhin 238  
suiiei-bō 238  
suiuin 289  
suihei-biyoku 210  
suiheiki 187  
suijō hikōki 211  
suijō supōtsu 241  
suijōsuki 241  
suijōsuki ita 241  
suijōsukiya 241  
suika 127  
suikazura 297  
suikeiki 80  
suikomi hōsu 77  
suikyū 239  
suimin 74  
suimin'yaku 109  
suimbōdō 238  
suingu suru 232  
suionkei 201  
suisai enogu 274  
suisai 280  
suiseki 288  
suisen 111  
suishitsu 61  
suishō ryōhō 55  
suishōtai 51  
suisu 316  
suitchi 60  
suitō 44, 206, 267  
suīto chokorēto 113  
suitō-gakari 96  
suiyōbi 306  
suiyōsei 109  
suizō 18  
suji 126  
sūji 308  
sukāfu 36  
sukaidaibingu 248  
sukasshu 231  
sukāto 30, 34  
suketchi 235  
suketchi bukku 275  
sukēto 224  
sukēto de suberu 224  
sukēto-gutsu 247  
sukētōbōdō 249, 263  
sukētōbōdō-nori 249  
suki 246  
suki ita 246  
suki-gutsu 246  
suki-jō 246  
sukimu miruku 136  
sukinkea 108  
sukiwea 246  
sukiya 246  
sukoabōdō 225  
sukoppu 89, 187  
sukoshi 320  
sukotchi 151  
sukūpu 149  
sukuraburu 272
- sukuramburu eggu 157  
sukuramu 221  
sukurēpā 82  
sukurōrubā 177  
sukūru basu 196  
sukuryū doraibā 151  
sukūtā 205  
sukuwatto 251  
sukyan 48, 52  
sukyanā 176  
sukyūba daibingu 239  
sumasshu 231  
sumi 266  
sumimasen 322  
sumō 237  
sumomo 129  
sumpō 165  
suna 264  
suna no shiro 265  
sunaba 263  
sunakku bā 148  
sunappu 30  
sunatsuchi 85  
sune 12  
sunea doramu 257  
sunikā 31, 37, 251  
sunōbōdō 247  
sunōkeru 239  
sunōmōbiru 247  
sunōsūtsu 30  
sunūkā 249  
supaiku 233  
supāku puragu 203  
sūpāmāketto 106  
supana 80  
supea ribu 155  
supea taiya 203  
supēdo 273  
supein 316  
supēsu shatoru 281  
supīdo kukku 130  
supīdo otose 323  
supīdo sukēto 247  
supikā 176, 258  
supikā sutando 268  
supin 230  
supoito 109, 167  
supōku 207  
suponji 73, 74, 83  
suponji fingā 141  
suponji kēki 140  
supōtsu 218  
supōtsu firudo 168  
supōtsu fisshingu 245  
supōtsu jaketto 33  
supōtsu jimu 250  
supōtsu kā 199  
supōtsu yōhin 105  
supōtsu-yō burajā 35  
supōtsuman 191  
supottoraito 259  
suppai 127  
sūpu 153, 158  
supūn 65  
supurē 109  
supurē kan 311  
supureddo 135
- supuringu 71  
supuringu onion 125  
supurinkurā 89  
supuritto pi 131  
supuroketto 207  
supūru 245, 271  
sūpusupūn 65  
sūpuzara 65  
suraidingu suru 229  
suraido 167  
suraisā 139  
suraisu 139, 230  
suraisu shokupan 138  
surakkusu 34  
surasutā 281  
surī doa 200  
surī-pointo rain 226  
suribachi 68  
surikizu 46  
surikogi 68  
surinamu 315  
suriorosu 67  
surippa 31  
surippon 37  
surippu 35  
suripūsūtsu 30  
surirā 255  
suriranka 318  
surō-in 223, 226  
surobakia 316  
surobenia 316  
surototoru 204  
sushi 121  
sūshiki 165  
suso 34  
supea 76  
sutaffudo oribu 143  
sutāfurūtsu 128  
sutampu 225  
sutampo dai 173  
sutando 88, 166, 205, 207, 268  
sutansu 232  
sutātingu burokku 234  
sutāto dai 238  
sutāto rain 234  
sutemu 112  
sutenresu 79  
sutenshiru 83  
suteppā 250  
sutereo 269  
sutēshonwagon 199  
sutikku 133, 224, 249  
sutiru 144  
sūto 273  
sutokkingu 35  
sutokku 246  
sutoppā 166  
sutoppuwotchi 234  
sutoraiiku 228  
sutorappu 35, 37  
sutorappuresu 34  
sutorēnā 68  
sutoresu 55  
sutoretschi 251  
sutorēto 39  
sutorēto ni suru 39  
sutorō 144, 154



- sutorōku 231, 233  
 sūtsu 32  
 suwajirando 317  
 suwēden 316  
 suzu 289  
 Suzuki 120  
 Suzume 292
- T**  
 ta no kōgei 275  
 ta no supōtsu 248  
 tabako 112, 184  
 tabako hitohako 112  
 tabemono 116, 149  
 taberu 64  
 tābochājā 203  
 tabun 322  
 tachiyogijō suru 239  
 tadashi 321  
 tagayasu 183  
 tāgetto shageki 249  
 tai 120, 318  
 tai'iku 162  
 tai'in 48  
 taiban 52  
 taiburēku 230  
 taibutsu renzu 167  
 taifū 286  
 taiheiyō 312  
 taihi 88  
 taihi-zumi 85  
 taiho 94  
 taiji 52  
 taijō suru 223  
 taijū-kei 45  
 taikakusen 164  
 taikiken 282, 286  
 taikyokuken 237  
 taimā 166  
 taimingu 203  
 taimu 133  
 taimu auto 220  
 tainetsusei 69  
 taionkei 45  
 tairiku 282, 315  
 tairu o haru 82  
 tairyūken 286  
 taiseiyō 312  
 taiseki 165  
 taisekigan 288  
 taishoku suru 26  
 taisō kyōgi 235  
 taisō senshu 235  
 taitsu 251  
 Taiwan 319  
 taiya 198, 205, 206  
 taiya kūkiatsu 203  
 taiya o kōkan suru 203  
 taiya rebā 207  
 taiyō 280, 282  
 taiyōkei 280  
 tajikisutan 318  
 takai 321  
 takarakuji 112  
 takasa 165  
 takatobikomi 239  
 take 86
- takenoko 122  
 taki 285  
 takkingu suru 241  
 takkuru 245  
 takkuru bokkusu 244  
 takkuru suru 220, 221, 223  
 takkyū 231  
 tako 121, 295  
 takomētā 201  
 takuhai 99, 154  
 takusan 320  
 takushī no untenshu 190  
 takushī noriba 213  
 tamago 137  
 tamanegi 124  
 tambaran 257  
 tamburā 65  
 tameiki o tsuku 25  
 tāminaru 212  
 tamo 244  
 tampa 179  
 tampan 33  
 tampon 108  
 tampopo 123, 297  
 tan 118  
 tana 66, 67, 106  
 tandemu jitensha 206  
 tane 88, 122, 127, 128, 130, 131  
 tane o maku 183  
 tane o ueru 90  
 tane-iri pan 139  
 tanemaki torei 89  
 tanenashi 127  
 tanensō 86  
 tangutsu 37  
 taniku shokubutsu 87  
 tanima 284  
 tanjerin 126  
 tanjō 52  
 tanjō pāti 27  
 tanjōbi 27  
 tanjōbi kēki 141  
 tanjōbi kēki no rōsoku 141  
 tanka 94  
 tanku 239  
 tankyori sōsha 234  
 tanryū 130  
 tanshin 50, 304  
 tansu 70  
 tansui-zuri 245  
 tanuki 290  
 tanzania 317  
 taoru 73  
 taorukake 72  
 tappu 150  
 tara 120  
 taragon 133  
 taroimo 124  
 tarukamu paudā 73  
 taruki 186  
 tārūmaku 187  
 taruto-gata 69  
 tasu 165  
 tasumania 319  
 tatchi rain 221  
 tatchiauto suru 229  
 tatchidaun 220
- tategami 242, 291  
 tatemono 299  
 tatemono to kōzō 300  
 tateru 186  
 tatsu-no-otoshigo 294  
 taunhausu 58  
 tawara 184  
 tazuna 242  
 te 13, 15, 273  
 teate 47  
 tebaniku 119  
 tebiki noko 81  
 tebukuro 36  
 tēburu 64, 148, 210  
 tēburu settingu 65, 152  
 tēburukurosu 64  
 techō 175  
 tedibea 75  
 tefuron kakō 69  
 tegami 98  
 tei-shigeki sei 41  
 teian sho 174  
 teiden 60  
 teien 261  
 teiki kankōbutsu 168  
 teiki-ryokakki 210, 212  
 teimen 164  
 teiō sekkai 52  
 teionsakkin 137  
 teionsakkin shiteinai 137  
 teire suru 91  
 teisha botan 197  
 teisha kinshi 195  
 teishi 269  
 teishibō niku 118  
 teishibō-nyū 136  
 teitetsu 242  
 tejō 94  
 tekira 145  
 tekondō 236  
 tekubi 13, 15  
 tekunikku 79  
 tēma paku 262  
 tembin 166  
 tembōtō 215  
 tempu shorui 177  
 tempuku suru 241  
 ten 273  
 ten'in 104, 188  
 tenimotsu 211, 213  
 tenisu 230  
 tenisu kōto 230  
 tenisu senshu 231  
 tenisu-gutsu 231  
 tenji-hin 261  
 tenjō 62  
 tenkan 44  
 tenmongaku 281  
 tennai inshoku 154  
 tennen sen'i 31  
 tennōsei 280  
 tenohira 15  
 tenrankai 261  
 tentaibōenkyō 281  
 tenteki 53  
 tento 267  
 tento o haru 266
- tentōmushi 295  
 teoshi kato 233  
 tēpu kattā 173  
 tērādō 35  
 terasu 58  
 terasu gāden 84  
 terasu kafe 148  
 terebi gēmu 269  
 terebi o kesu 269  
 terebi o miru 269  
 terebi o tsukeru 269  
 terebi sutajio 178  
 terepin-yu 83  
 teroppu 179  
 tēru raito 207  
 tēru rampu 204  
 tesuri 59, 196  
 tesūryō 97  
 tetsumaru 289  
 tetsubō 235  
 tetsubun 109  
 tetsudō-mō 209  
 tetsugaku 169  
 tī 233  
 tī baggu 144  
 tī guraundo 232  
 tīkappu 65  
 tin'ējā 23  
 tīpotto 65  
 tīshatsu 30, 33  
 tīshotto o uchidasu 233  
 tīsshu 108  
 tīsshu no hako 70  
 tīsūpūn 65  
 tō 300  
 to issho ni 320  
 tō kurippu 207  
 tō sutorappu 207  
 to'on kigō 256  
 tobi-geri 237  
 tobi-ita 238  
 tobikomi 239  
 tobikomi senshu 238  
 tobikomi sutāto 239  
 tobikomu 238  
 tobira 209  
 tobu 211  
 tōbu gaishō 46  
 tōchaku bin 213  
 tōdai 217  
 todana 66  
 todana rokku 75  
 tofi 113  
 tōgarashi 132, 143  
 toge 46  
 tōgei 275  
 togi-bō 118  
 tōgo 317  
 togurubotan 31  
 tōhi 39  
 tōi 320  
 toiwase 168  
 toire 61, 266  
 toire burashi 72  
 toiretto pēpā 72  
 toishi 81  
 tōjiki 105
- tōjōken 213  
 tokage 293  
 tokei 62, 304  
 toko ni tsuku 71  
 tōkotsu 17  
 tokoya 39, 188  
 tokubai 322  
 tokubaihin 106  
 tokuten 220, 273  
 tōkyū suru 225, 229  
 tomare 323  
 tomato 125, 157  
 tomato jūsu 144, 149  
 tombo 295  
 tomegane 37  
 tōmei hachimitsu 134  
 tomodachi ni naru 26  
 tōmorokoshi 122, 130, 184  
 tōmorokoshi pan 139  
 ton 310  
 tōnamento 233  
 tongu 167  
 tonikku wōtā 144  
 tōnyōbyō 44  
 topāzu 288  
 topiari 87  
 toppingu 155  
 toppu 246  
 toppu chūbu 207  
 tora 291  
 toraffuru 113  
 toragu 88  
 torai 221  
 toraiauguru 257  
 toraifuru 141  
 torakku 194, 234  
 torakku no untenshu 190  
 torakkusūtsu 31, 32  
 torakutā 182  
 torampetto 257  
 torampu 273  
 torampu hito-kumi 273  
 toranku 198  
 toranku rūmu 196  
 toreddo 207  
 toreddomiru 250  
 torei 152, 154  
 torekkingu 243  
 torēn 35  
 torēnā 33  
 torēningu suru 251  
 torērā 266  
 torerisu 84  
 tori 119  
 tōri 298  
 torigoya 185  
 torihikisaki 175  
 torimā 88  
 torinidādo tobago 314  
 toriniku 119  
 toronbōn 257  
 tororī basu 196  
 toruko 318  
 torukoishi 289  
 torukumenisutan 318  
 torumarin 288

toryō baketsu 83  
 toryō-yō shinnā 83  
 toryufu 125  
 toshi 299, 306, 307  
 tōshi 97  
 tosho kādo 168  
 tosho mokuroku 168  
 toshokan 168, 299  
 tosō suru 83  
 tōsutā 66  
 tōsuto 157  
 tōsuto-sando 149  
 totte 37, 88, 106  
 tōyaku 109  
 tōzayokin kōza 96  
 tsū doa 200  
 tsuarā 205  
 tsubame 292  
 tsubasa 210, 293  
 tsubomi 111, 297  
 tsubu masutādo 135  
 tsubushita 132, 159  
 tsuchifumazu 15  
 tsūden rēru 209  
 tsūgaku kaban 162  
 tsugiki suru 91  
 tsuihi suru 90  
 tsuin rūmu 100  
 tsukaisute 109  
 tsukaisute kamera 270  
 tsukaisute kamisori 73  
 tsukeru 130  
 tsuki 237, 280, 306  
 tsukichakurikusen 281  
 tsūkinsha 208  
 tsūkō kinshi 323  
 tsukue 162, 172  
 tsukurō 277  
 tsuma 22  
 tsumaranai 321  
 tsume 15, 291, 293  
 tsume yasuri 41  
 tsumekiri 41  
 tsumekiri-basami 41  
 tsumememo 50, 159  
 tsumetai 321  
 tsumitoru 91  
 tsumu 91  
 tsumujikaze 287  
 tsunagi 83  
 tsunagu 91  
 tsuno 291  
 tsurara 287  
 tsuri 244  
 tsuri kyokashō 245  
 tsuri no shurui 245  
 tsuri'ito 244  
 tsuribari 244  
 tsuribito 244  
 tsurigane suisen 297  
 tsūringu jitensha 206  
 tsurisage-shiki forudā 173  
 tsuriwa 235  
 tsurizao 244  
 tsūro 106, 168, 210, 212, 254  
 tsuru 245, 292  
 tsūrubā 177

tsuruhashi 187  
 tsurusei shokubutsu 87  
 tsutsugiri 121  
 tsutsumi 311  
 tsūwa-chū 99  
 tsuyadashi 83  
 tsuyadashizai 77  
 tsuyakeshi 83  
 tsuyoi 321  
 tsuzuru 162

## U

ubaguruma 75  
 uchigawa 320  
 uchiwasaboten 128  
 uchū 280  
 uchū sutēshon 281  
 uchū tanken 281  
 uchūfuku 281  
 uchūhikōshi 281  
 uchūkūkan 280  
 uddo 233  
 ude 13, 95  
 udedokei 36  
 udetatefuse 251  
 ue e 320  
 ue-kaeru 91  
 ueki 87, 110  
 uekibachi 89  
 ueru 183  
 uesuto 12  
 uesutobando 35  
 ugai dai 50  
 uganda 317  
 ugokasu 251  
 uikyō 122, 133  
 uikyō no tane 133  
 uindo-shirudo 205  
 uindoburēkā 33  
 uindosāfā 241  
 uindosāfin 241  
 uirusu 44  
 uisuki 145  
 ukairo 195, 323  
 uke 237  
 ukegane 276  
 ukeru 227  
 uketsuke-gakari 190  
 uki 244  
 ukidama 61  
 ukiwa 265  
 ukon 132  
 ukuraina 316  
 uma 185, 242  
 umareru 26  
 umate 243  
 umaya 185, 243  
 umeru 82  
 umi 264, 282  
 umi no ie 264  
 umibe 264  
 umizuri 245  
 unagi 294  
 undō 251  
 unmo 289  
 unten seki 196  
 unten shitsu 208

unten suru 195  
 untendai 95  
 untenshu 196  
 uraji 32  
 urauchi-gami 83  
 ureshi 25  
 uriba annai 104  
 urin 285  
 uroko 121, 293, 294  
 uroko o totta 121  
 uruguai 315  
 urusai 321  
 usagi 290  
 usagi niku 118  
 usetsu kinshi 195  
 usugiri 119  
 usui 321  
 uta 259  
 utsu 79, 224, 225, 229  
 utsukushi 321  
 uwagi 32  
 uwanuri 83  
 uwazara 310  
 uyoku 229  
 uzubekisutan 318  
 uzura 119  
 uzura mame 131  
 uzura tamago 137

## W

waffuru 157  
 wagomu 173  
 wagon 172  
 waido gamen terebi 269  
 wain 145, 151  
 wain risuto 152  
 wain su 135  
 waingurasu 65  
 waipā 198  
 waishatsu 32  
 waiyā kappu 35  
 waiyā kattā 81  
 waiyā sutorippā 81  
 wakai 321  
 waki no shita 13  
 wakimichi 299  
 wakkusu 41  
 wakusei 280, 282  
 wambokkusu kā 199  
 wampisu 31, 34  
 waniguchi kurippu 167  
 wanshotto 151  
 warau 25  
 waribiki ryōkin 322  
 waru 165  
 warui 321  
 wasabi 124  
 washi 292  
 wasshā 80  
 wata o totta 121  
 waza 237  
 webusaito 177  
 wēdā 244  
 wedingu kēki 141  
 wedingudoresu 35  
 weitā 148, 152  
 weito beruto 239

weito torēningu 251  
 weitoresu 191  
 weiji 233  
 wetto tisshu 108  
 wettosūtsu 239  
 wicketto 225  
 wicketto-kipā 225  
 windō 177  
 windorasu 214  
 wintā supōtsu 247  
 wokka 145  
 wōtā gāden 84  
 wōtā hazādo 232

## Y

ya 249  
 yachin 58  
 yachō kansatsu 263  
 yādo 310  
 yagai katsudō 262  
 yagi 185  
 yagi chizu 142  
 yagi-nyū 136  
 yaita 159  
 yakedo 46  
 yakisoba 158  
 yakkyoku 108  
 yaku 67, 138  
 yakumi 135  
 yakusō 55  
 yakusō-zai 108  
 yakuzaiishi 108, 189  
 yakyū 228  
 yakyū o suru 229  
 yakyūbō 36  
 yama 284  
 yamaimo 125  
 yanagi 296  
 yane 58, 203  
 yane-gawara 58, 187  
 yaneura-beya 58  
 yaoya 114, 188  
 yarinage 234  
 yasai 107, 122, 124  
 yasai-shitsu 67  
 yasei mai 130  
 yashi 296  
 yashi no ki 86  
 yasu ryō 245  
 yasui 321  
 yasuri 81  
 yawarakai 129, 321  
 yazutsu 249  
 yoake 305  
 yōbi 306  
 yobidashi botan 48  
 yobidashijō 180  
 yobirin 59  
 yobō-sesshu 45  
 yodarekake 30  
 yōfukudansu 70  
 yoga 54  
 yōgan 283  
 yōgisha 94, 181  
 yogoremono 76  
 yōgu 233  
 yōguruto 137

yōgyōjō 183  
 yōhō 109  
 yoi 321  
 yoidome 109  
 yōji 30  
 yōjō shito 83  
 yōkeijō 183  
 yōki 311  
 yōki-iri inryōsui 144  
 yokogura 242  
 yokushitsu 72  
 yokushitsu-yō kyabinetto 72  
 yokusō 72  
 yōkyū 249  
 yome 22  
 yomu 162  
 yon 308  
 yon banme 309  
 yōnashi 126  
 yonhyaku 308  
 yonjū 308  
 yonjū banme 309  
 yonjūppun 304  
 yonrin kudōsha 199  
 yontōkin 16  
 yōnyū 137  
 yori yoi 321  
 yoroido 58  
 yōroppa 316  
 yoru 305  
 yorudan 318  
 yōryō 109, 311  
 yōseki 311  
 yosenami 241  
 yōshi gaido 172  
 yōsui 52  
 yōsui senshi 52  
 yotei 175  
 yōtonjō 183  
 yōtsui 17  
 yotto 215, 240  
 yowai 321  
 yoyaku 45  
 yoyaku suru 168  
 yōzai 83  
 yubi no kansetsu 15  
 yūbin-bangō 98  
 yūbin-bukuro 98  
 yūbin haitatsunin 98  
 yūbin kaban 190  
 yūbin kawase 98  
 yūbin posuto 99  
 yūbin-uke 58, 99  
 yūbinhaitatsu 190  
 yūbinkyoku 98  
 yūbinkyoku-in 98  
 yubinuki 276  
 yubiwa 36  
 yuderu 67  
 yudeta 159  
 yudetamago 137, 157  
 yūen 199  
 yūenchi 262  
 yūgure 305  
 yūhodō 265  
 yūigonjō o kaku 26  
 yūjin 24

yuka 58, 62, 71  
yuka undō 235  
yūkari 296  
yuki 287  
yūki 91, 122  
yūki gomi 61  
yūki-sei 118  
yukkurishita 321  
yumi 249  
yuminoko 81  
yuri 110  
yūryō channeru 269  
yusei kan 21  
yūshoku 64  
yūsō-ryō 98  
yusugu 38  
yutampo 70  
yutiririti rūmu 76  
yūzai 181  
yuzure 323

## Z

zabuton 64, 152  
zaijō 180  
zaijōnimpi 180  
zaimoku 187  
zairyō 79  
zakuro 128  
zambia 317  
zamen 64  
zarugai 121  
zaseki 209, 210, 254  
zaseki haichi 254  
zasshi 107, 112, 168  
zassō 86  
zassō kari-basami 88  
zataku 152  
zayaku 109  
zei 96  
zeikan 212, 216  
zekken 226  
zemu kurippu 173  
zenkyō 242  
zennyū 136  
zenrin 196, 210  
zenritsusen 21  
zenryū 130  
zenryū pan 139  
zenryū-fun 138  
zensai 153  
zensoku 44  
zentōdō 19  
zentōkin 16  
zenwan 12  
zeribīnzu 113  
zetsuen tēpu 81  
zō 291  
zōchiku bubun 58  
zōen suru 91  
zōsen-jo 217  
zubon 32  
zuga 274  
zugaihotsu 17  
zukkini 125  
zūmu renzu 270  
zunō 19  
zutsū 44



## 英語索引 eigo sakuin • English index

## A

à la carte 152  
 abdomen 12  
 abdominals 16  
 above 320  
 abseiling 248  
 acacia 110  
 accelerator 200  
 access road 216  
 accessories 36, 38  
 accident 46  
 account number 96  
 accountant 97, 190  
 accounts department 175  
 accused 180  
 ace 230, 273  
 Achilles tendon 16  
 acorn squash 125  
 acquaintance 24  
 acquitted 181  
 across 320  
 acrylic paints 274  
 actions 237, 229, 227, 233, 183  
 activities 263, 245, 162, 77  
 actor 254, 191  
 actors 179  
 actress 254  
 acupressure 55  
 acupuncture 55  
 Adam's apple 19  
 add v 165  
 address 98  
 adhesive tape 47  
 adjustable spanner 80  
 admissions 168  
 admitted 48  
 aduki beans 131  
 adult 23  
 advantage 230  
 adventure 255  
 advertisement 269  
 aerate v 91  
 aerobics 251  
 Afghanistan 318  
 Africa 317  
 after 320  
 afternoon 305  
 aftershave 73  
 aftersun 108  
 agate 289  
 agenda 174  
 aikido 236  
 aileron 210  
 air bag 201  
 air conditioning 200  
 air cylinder 239  
 air filter 202, 204  
 air letter 98  
 air mattress 267  
 air stewardess 190  
 air supply 199  
 air vent 210  
 aircraft 210  
 aircraft carrier 215  
 airliner 210, 212  
 airport 212  
 aisle 106, 168, 210, 254  
 alarm clock 70  
 Alaska 314  
 Albania 316  
 alcoholic drinks 145  
 alfalfa 184  
 Algeria 317  
 allergy 44  
 alley 298  
 alligator 293  
 allspice 132  
 almond 129  
 almond oil 134  
 almonds 151  
 along 320  
 alpine 87  
 alpine skiing 247  
 alternating current 60  
 alternative therapy 54  
 alternator 203  
 altitude 211  
 aluminum 289  
 Amazonia 312  
 ambulance 94  
 American football 220  
 amethyst 288  
 amniocentesis 52  
 amniotic fluid 52  
 amount 96  
 amp 60  
 amphibians 294  
 amplifier 268  
 anchor 214, 240  
 Andes 312  
 Andorra 316  
 anesthesiologist 48  
 angle 164  
 angler 244  
 Angola 317  
 angry 25  
 animals 292, 294  
 animated film 255  
 ankle 13, 15  
 ankle-length 34  
 anniversary 26  
 annual 86, 307  
 anorak 31, 33  
 answer 163  
 answer v 99, 163  
 answering machine 99  
 ant 295  
 antenna 295  
 antifreeze 199, 203  
 Antigua and Barbuda 314  
 anti-inflammatory 109  
 antique shop 114  
 antiseptic 47  
 antiseptic wipe 47  
 antiwrinkle 41

antler 291  
 apartment building 59, 298  
 apéritif 153  
 aperture dial 270  
 apex 165  
 appeal 181  
 appearance 30  
 appendix 18  
 applaud v 255  
 apple 126  
 apple corer 68  
 apple juice 149  
 appliances 66  
 application 176  
 appointment 45, 175  
 apricot 126  
 April 306  
 apron 30, 50, 69, 212  
 APS camera 270  
 aquamarine 288  
 Arabian Sea 313  
 arable farm 183  
 arborio rice 130  
 arc 164  
 arch 15, 85, 301  
 archery 249  
 architect 190  
 architecture 300  
 architrave 301  
 Arctic Circle 283  
 Arctic Ocean 312  
 area 165, 310  
 areas 299  
 arena 243  
 Argentina 315  
 arithmetic 165  
 arm 13  
 armband 238  
 armchair 63  
 Armenia 318  
 armpit 13  
 armrest 200, 210  
 aromatherapy 55  
 around 320  
 arrangements 111  
 arrest 94  
 arrivals 213  
 arrow 249  
 art 162  
 art college 169  
 art deco 301  
 art gallery 261  
 art nouveau 301  
 art shop 115  
 artery 19  
 artichoke 124  
 artist 274  
 arts and crafts 274, 276  
 arugula 123  
 ash 283  
 ashtray 150  
 Asia 318  
 assault 94  
 assistant 24  
 assisted delivery 53  
 asteroid 280  
 asthma 44  
 astigmatism 51  
 astronaut 281  
 astronomy 281  
 asymmetric bars 235  
 at 320  
 athlete 234  
 Atlantic Ocean 312  
 atmosphere 282, 286  
 atrium 104  
 attachment 177  
 attack 220  
 attack zone 224  
 attend v 174  
 attic 58  
 attractions 261  
 auburn 39  
 audience 254  
 August 306  
 aunt 22  
 aurora 286  
 Australasia 319  
 Australia 319  
 Austria 316  
 autocue 179  
 automatic 200  
 automatic door 196  
 autumn 31, 307  
 avalanche 247  
 avenue 299  
 avocado 128  
 awning 148  
 ax 95  
 axle 205  
 ayurveda 55  
 Azerbaijan 318  
 B  
 baby 23, 30  
 baby bath 74  
 baby care 74  
 baby carriage 75  
 baby changing facilities 104  
 baby monitor 75  
 baby products 107  
 baby sling 75  
 babygro 30  
 back 13  
 back brush 73  
 back seat 200  
 backboard 226  
 backdrop 254  
 backgammon 272  
 backhand 231  
 backpack 31, 37, 267  
 backstroke 239  
 backswing 233  
 bacon 118, 157  
 bad 321  
 badge 94  
 badminton 231  
 bag 311  
 bagel 139  
 baggage claim 213  
 baggage trailer 212  
 bags 37  
 baguette 138  
 Bahamas 314  
 bail 181  
 bait 244  
 bait v 245  
 bake v 67, 138  
 baked 159  
 baker 139  
 baker's 114  
 bakery 107, 138  
 baking 69  
 baking tray 69  
 balance wheel 276  
 balcony 59, 254  
 bald 39  
 bale 184  
 Balearic Islands 316  
 ball 15, 75, 221, 224, 226, 228, 230  
 ballboy 231  
 ballet 255  
 balsamic vinegar 135  
 Baltic Sea 313  
 bamboo 86, 122  
 banana 128  
 bandage 47  
 Bangladesh 318  
 banister 59  
 bank 96, 284  
 bank charge 96  
 bank manager 96  
 bank transfer 96  
 bar 150, 152, 250, 256, 311  
 bar code 106  
 bar counter 150  
 bar mitzvah 26  
 bar snacks 151  
 bar stool 150  
 barb 244  
 Barbados 314  
 barbecue 267  
 barber 39, 188  
 bark 296  
 barley 130, 184  
 barman 191  
 barn 182  
 baroque 301  
 bars 74  
 bartender 150  
 basalt 288  
 base 164, 229  
 base station 99  
 baseball 228  
 baseline 230  
 baseman 228  
 basement 58

- basil 133  
 basin 50  
 basket 106, 207, 226  
 basket of fruit 126  
 basketball 226  
 basketball player 226  
 bass clarinet 257  
 bass clef 256  
 bass guitar 258  
 bass guitarist 258  
 bassinet 74  
 bassoon 257  
 bat 225, 228, 231, 290  
 bat v 225, 229  
 bath mat 72  
 bath towel 73  
 bathrobe 73  
 bathroom 72  
 bathtub 72  
 baton 235, 256  
 batsman 225  
 batter 228  
 batteries 260  
 battery 167, 202  
 battery pack 78  
 battleship 215  
 bay leaf 133  
 bayonet fitting 60  
 be born v 26  
 beach 264  
 beach bag 264  
 beach ball 265  
 beach hut 264  
 beach towel 265  
 beach umbrella 264  
 beaker 167  
 beam 186, 235  
 bean sprout 122  
 beans 131, 144  
 bear 291  
 beat 259  
 beauty 40, 105  
 beauty treatments 41  
 bed 70, 71  
 bed and breakfast 101  
 bedding 74  
 bedroom 70  
 bedside lamp 70  
 bedside table 70  
 bedspread 70  
 bee 295  
 beech 296  
 beef 118  
 beer 145, 151  
 beer tap 150  
 beetle 295  
 beets 125  
 before 320  
 beginning 321  
 behind 320  
 Belarus 316  
 Belgium 316  
 Belize 314  
 bell 197  
 below 320  
 belt 32, 36, 236  
 bench 250, 262  
 Benin 317  
 berry 296  
 beside 320  
 bet 273  
 between 320  
 beyond 320  
 Bhutan 318  
 biathlon 247  
 bib 30  
 bicep curl 251  
 biceps 16  
 bicycle 206  
 bicycle v 207  
 bidet 72  
 biennial 86  
 bifocal 51  
 big toe 15  
 bike rack 207  
 bikini 264  
 bill 152, 293  
 binoculars 281  
 biology 162  
 biplane 211  
 birch 296  
 bird watching 263  
 birds 292  
 birth 52  
 birth weight 53  
 birth certificate 26  
 birthday 27  
 birthday cake 141  
 birthday candles 141  
 birthday party 27  
 biscuits 141  
 bishop 272  
 bit 242  
 bit brace 78  
 bite 46  
 bite v 245  
 bitter 124, 145  
 black 39, 272, 274  
 black belt 237  
 black coffee 148  
 black hole 280  
 black olive 143  
 black pudding 157  
 Black Sea 313  
 black tea 149  
 bottom tier 141  
 blackberry 127  
 blackboard 162  
 blackcurrant 127  
 black-eyed beans 131  
 bladder 20  
 blade 60, 66, 78, 89  
 blanket 71, 74  
 blazer 33  
 bleach 77  
 blender 66  
 blister 46  
 block 237  
 block v 227  
 blonde 39  
 blood pressure 44  
 blood pressure gauge 45  
 blood test 48  
 blouse 34  
 blow dry v 38  
 blow out v 141  
 blowhole 290  
 blue 274  
 blue cheese 136  
 bluebells 297  
 blueberry 127  
 blues 259  
 blusher 40  
 board 241  
 board v 217  
 board games 272  
 boarding pass 213  
 bob 39  
 bobbin 276  
 bobsled 247  
 body 12  
 body lotion 73  
 body systems 19  
 bodywork 202  
 boil v 67  
 boiled egg 137, 157  
 boiler 61  
 bok choy 123  
 Bolivia 315  
 bollard 214, 298  
 bolt 59  
 bomber 211  
 bone 17, 119, 121  
 bone meal 88  
 boned 121  
 bongos 257  
 bonnet 198  
 book 168  
 book a flight v 212  
 book shop 115  
 bookshelf 63, 168  
 boom 95, 240  
 booster 281  
 boot 198, 220, 223  
 booties 30  
 bored 25  
 borrow v 168  
 Bosnia and Herzegovina 316  
 Botswana 317  
 bottle 61, 75, 135, 311  
 bottle opener 68, 150  
 bottled foods 134  
 bottled water 144  
 bottom tier 141  
 bounce v 227  
 boundary line 225  
 bouquet 35, 111  
 bouquet garni 132  
 bout 237  
 boutique 115  
 bow 240, 249  
 bow tie 36  
 bowl 61, 65, 112  
 bowl v 225  
 bowler 225  
 bowling 249  
 bowling ball 249  
 box 254  
 blood pressure 44  
 box file 173  
 box of chocolates 113  
 box of tissues 70  
 box office 255  
 boxer shorts 33  
 boxercise 251  
 boxing 236  
 boxing gloves 237  
 boxing ring 237  
 boy 23  
 boyfriend 24  
 bra 35  
 braces 50  
 bracelet 36  
 braid 39  
 brain 19  
 brake 200, 204, 206  
 brake v 207  
 brake block 207  
 brake fluid reservoir 202  
 brake lever 207  
 brake pedal 205  
 bran 130  
 branch 175, 296  
 brandy 145  
 brass 256  
 Brazil 315  
 brazil nut 129  
 bread 157  
 bread knife 68  
 bread roll 143  
 breadcrumbs 139  
 breads 138  
 break a record v 234  
 break waters v 52  
 breakdown 203  
 breakfast 64, 156  
 breakfast buffet 156  
 breakfast cereals 107  
 breakfast table 156  
 breakfast tray 101  
 breast 12, 119  
 breast bone 17  
 breast pump 53  
 breastfeed v 53  
 breaststroke 239  
 breathing 47  
 breech 52  
 brick 187  
 bridge 15, 214, 258, 273, 300  
 bridle 242  
 bridle path 263  
 brie 142  
 briefcase 37  
 briefs 33, 35  
 brioche 157  
 broadcast 179  
 broadcast v 178  
 broccoli 123  
 brochure 175  
 bronze 235  
 brooch 36  
 broom 77  
 broth 158  
 brother 22  
 brother-in-law 23  
 browband 242  
 brown 274  
 brown bread 139, 149  
 brown flour 138  
 brown lentils 131  
 brown rice 130  
 browse v 177  
 browser 177  
 bruise 46  
 Brunei 319  
 brunette 39  
 brush 38, 40, 77, 83, 274  
 brush v 38, 50  
 brussel sprout 122  
 bubble bath 73  
 bucket 77, 82, 265  
 buckle 36  
 bud 111, 297  
 buffet 152  
 buggy 232  
 build v 186  
 builder 186, 188  
 building site 186  
 buildings 299  
 bulb 86  
 Bulgaria 316  
 bull 185  
 bulldog clip 173  
 bullet train 209  
 bull-nose pliers 80  
 bulseye 273  
 bumper 74, 198  
 bun 39, 139, 140, 155  
 bunch 111  
 bungalow 58  
 bungee jumping 248  
 bunker 232  
 bunsen burner 166  
 buoy 217  
 bureau de change 97  
 burger 154  
 burger bar 154  
 burger meal 154  
 burglar alarm 58  
 burglary 94  
 Burkina Faso 317  
 Burma (Myanmar) 318  
 burn 46  
 burner 67  
 Burundi 317  
 bus 196  
 bus driver 190  
 bus shelter 197  
 bus station 197  
 bus stop 197, 299  
 bus ticket 197  
 buses 196  
 business 175  
 business class 211  
 business deal 175  
 business lunch 175  
 business partner 24  
 business suit 32  
 business trip 175  
 businessman 175  
 businesswoman 175  
 bustier 35  
 butcher 118, 188  
 butcher's 114  
 butter 137, 156  
 butter beans 131  
 buttercup 297  
 butterfly 239, 295  
 buttermilk 137  
 butternut squash 125  
 buttock 13, 16  
 button 32

buttonhole 32  
 buttress 301  
 by 320  
 by airmail 98  
 bytes 176

**C**

cab 95  
 cabbage 123  
 cabin 210, 214  
 Cabinda 317  
 cabinet 66  
 cable 79, 207  
 cable car 246  
 cable television 269  
 cactus 87  
 caddy 233  
 café 148, 262  
 cafetière 65  
 cake shop 114  
 cake tin 69  
 cakes 140  
 calcite 289  
 calcium 109  
 calculator 165  
 calendar 306  
 calf 13, 16, 185  
 call button 48  
 calyx 297  
 cam belt 203  
 Cambodia 318  
 camcorder 260, 269  
 camel 291  
 camembert 142  
 camera 178, 260, 270  
 camera case 271  
 camera crane 178  
 camera shop 115  
 cameraman 178  
 Cameroon 317  
 camisole 35  
 camomile tea 149  
 camp v 266  
 camp bed 266  
 campari 145  
 camper van 266  
 campfire 266  
 camping 266  
 camping stove 267  
 campsite 266  
 campus 168  
 can 145, 311  
 can opener 68  
 Canada 314  
 canary 292  
 candied fruit 129  
 candle 63  
 cane 91  
 canes 89  
 canine 50  
 can 289, 311  
 canned drink 154  
 canned food 107  
 canoe 214  
 canoeing 241  
 canter 243  
 canvas 274  
 cap 21, 36, 238

capacity 311  
 cape gooseberry 128  
 capers 143  
 capital 315  
 capoeira 237  
 cappuccino 148  
 capsiz v 241  
 capsule 109  
 captain 214  
 car 198, 200  
 car accident 203  
 car hire 213  
 car stereo 201  
 car wash 198  
 caramel 113  
 caravan 266  
 caraway 131  
 card 27  
 card phone 99  
 card slot 97  
 cardamom 132  
 cardboard 275  
 cardigan 32  
 cardiology 49  
 cardiovascular 19  
 cards 273  
 cargo 216  
 Caribbean Sea 312  
 carnation 110  
 carnival 27  
 carousel 212  
 carpenter 188  
 carpentry bits 80  
 carpet 71  
 carriage 208  
 carriage race 243  
 carrier 204  
 carrot 124  
 cart 48, 100, 106, 213  
 cartilage 17  
 carton 311  
 cartoon 178  
 carve v 79  
 carving fork 68  
 case 51  
 cash v 97  
 cash machine 97  
 cashew 129, 151  
 cashier 96, 106  
 casino 261  
 Caspian Sea 313  
 casserole dish 69  
 cassette player 269  
 cassette tape 269  
 cast 254  
 cast v 245  
 castle 300  
 casual 34  
 casual wear 33  
 cat 290  
 catalog 168  
 catamaran 215  
 cataract 51  
 catch v 220, 227, 229, 245  
 catcher 229  
 caterpillar 295  
 cathedral 300  
 catheter 53

cauliflower 124  
 cave 284  
 CD player 268  
 cedar 296  
 ceiling 62  
 celebration 140  
 celebration cakes 141  
 celebrations 27  
 celeriac 124  
 celery 122  
 cell 181  
 cello 256  
 cell phone 99  
 cement 186  
 cement mixer 186  
 centimeter 310  
 centipede 295  
 Central African Republic 317  
 central processing unit 176  
 central reservation 194  
 center 164  
 center circle 222, 224, 226  
 center field 228  
 center line 226  
 centerboard 241  
 century 307  
 ceramic stovetop 66  
 cereal 130, 156  
 cervical vertebrae 17  
 cervix 20, 52  
 cesarean section 52  
 Chad 317  
 chain 36, 206  
 chair 64  
 chair v 174  
 chairlift 246  
 chalk 85, 162, 288  
 chamber 283  
 champagne 145  
 championship 230  
 change v 209  
 change a wheel v 203  
 change channel v 269  
 change gear v 207  
 changing bag 75  
 changing mat 74  
 changing room 104  
 channel 178  
 charcoal 266, 275  
 charge 94, 180  
 chart 48  
 chassis 203  
 check 96  
 checkbook 96  
 checkers 272  
 check-in v 212  
 check-in desk 213  
 checkout 106  
 checkup 50  
 cheddar 142  
 cheek 14  
 cheerleader 220  
 cheese 136, 156  
 chef 152, 190  
 chef's hat 190  
 chemistry 162  
 cherry 126  
 cherry tomato 124

chess 272  
 chessboard 272  
 chest 12  
 chest of drawers 70  
 chest press 251  
 chestnut 129  
 chewing gum 113  
 chick 185  
 chick peas 131  
 chicken 119, 185  
 chicken burger 155  
 chicken coop 185  
 chicken nuggets 155  
 chickenpox 44  
 chicory 122  
 child 23, 31  
 child lock 75  
 child seat 198, 207  
 childbirth 53  
 children 23  
 children's clothing 30  
 children's department 104  
 children's ward 48  
 child's meal 153  
 Chile 315  
 chili 124, 132, 143  
 chill 44  
 chimney 58  
 chin 14  
 China 318  
 china 105  
 Chinese leaves 122  
 chip v 233  
 chipboard 79  
 chiropractic 54  
 chisel 81, 275  
 chives 133  
 chocolate 113  
 chocolate bar 113  
 chocolate cake 140  
 chocolate chip 141  
 chocolate-coated 140  
 chocolate milkshake 149  
 chocolate spread 135  
 choir 301  
 choke v 47  
 chop 119, 237  
 chopping block 68  
 chopsticks 64  
 chorizo 143  
 choux pastry 140  
 christening 26  
 Christmas 27  
 chrysanthemum 110  
 chuck 78  
 church 298, 300  
 chutney 134  
 cider 145  
 cider vinegar 135  
 cigar 112  
 cigarettes 112  
 cilantro 133  
 cinema hall 255  
 cinnamon 133  
 circle 165, 254  
 circular saw 78  
 circuit training 251  
 circumference 164

cistern 61  
 citrus fruit 126  
 city 299  
 clam 121  
 clamp 78, 166  
 clamp stand 166  
 clapper board 179  
 clarinet 257  
 clasp 36  
 classical music 255, 259  
 classroom 162  
 claw 291  
 clay 85, 275  
 clean v 77  
 clean clothes 76  
 cleaned 121  
 cleaner 188  
 cleaning equipment 77  
 cleaning fluid 51  
 cleanser 41  
 clear honey 134  
 cleat 240  
 cleaver 68  
 clementine 126  
 client 38, 175, 180  
 cliff 285  
 climber 87  
 climbing frame 263  
 clinic 48  
 clipboard 173  
 clitoris 20  
 clock 62  
 clock radio 70  
 closed 260, 321  
 clothes line 76  
 clothes peg 76  
 clothing 205  
 cloud 287  
 cloudy 286  
 clove 125  
 clover 297  
 cloves 133  
 club 273  
 club sandwich 155  
 clubhouse 232  
 clutch 200, 204  
 coach 196  
 coal 288  
 coast 285  
 coaster 150  
 coastguard 217  
 coat 32  
 coat hanger 70  
 cockatoo 293  
 cockerel 185  
 cockle 121  
 cockpit 210  
 cockroach 295  
 cocktail 151  
 cocktail shaker 150  
 cocoa powder 148  
 coconut 129  
 cocoon 295  
 cod 120  
 coffee 144, 148, 153, 156, 184  
 coffee cup 65  
 coffee machine 148, 150  
 coffee milkshake 149



- coffee spoon 153  
 coffee table 62  
 cog 206  
 coin 97  
 coin phone 99  
 coin return 99  
 cola 144  
 colander 68  
 cold 44, 286, 321  
 cold faucet 72  
 cold-pressed oil 135  
 collage 275  
 collar 32  
 collarbone 17  
 colleague 24  
 collect call 99  
 collection 98  
 college 168  
 Colombia 315  
 colony 315  
 coloring pencil 163  
 colors 39, 274  
 comb 38  
 comb v 38  
 combat sports 236  
 combine harvester 182  
 comedy 255  
 comet 280  
 comforter 71  
 comic 112  
 commis chef 152  
 commission 97  
 communications 98  
 commuter 208  
 Comoros 317  
 compact 40  
 compact disk (CD) 269  
 company 175  
 compartment 209  
 compass 165, 312, 240  
 complaint 94  
 complexion 41  
 compliments slip 173  
 compost 88  
 compost heap 85  
 computer 172, 176  
 concealer 40  
 conceive v 20  
 conception 52  
 concert 255, 258  
 concertina file 173  
 concourse 209  
 concrete block 187  
 concussion 46  
 condensed milk 136  
 conditioner 38  
 condom 21  
 conductor 256  
 cone 164, 187  
 confectioner 113  
 confectionery 107, 113  
 confident 25  
 confused 25  
 conglomerate 288  
 Congo 317  
 conifer 86  
 connect v 177  
 connection 212  
 conning tower 215  
 console 269  
 constellation 281  
 construction 186  
 consultant 49  
 consultation 45  
 contact lenses 51  
 container 216, 311  
 container port 216  
 container ship 215  
 continent 282, 315  
 contraception 21, 52  
 contraction 52  
 control tower 212  
 controller 269  
 controls 201, 204  
 convector heater 60  
 convenience food 107  
 convertible 199  
 conveyer belt 106  
 cooked meat 118, 143  
 cookie 113  
 cooking 67  
 coolant reservoir 202  
 cooling rack 69  
 copilot 211  
 copper 289  
 copy v 172  
 coral reef 285  
 cordless phone 99  
 core 127  
 cork 134  
 corkscrew 150  
 corn 122, 130, 184  
 cornbread 139  
 corn oil 135  
 cornea 51  
 corner 223  
 corner flag 223  
 cornice 300  
 corset 35  
 Corsica 316  
 Costa Rica 314  
 costume 255  
 cot 74  
 cottage cheese 136  
 cottage garden 84  
 cotton 184, 277  
 cotton balls 41  
 cough 44  
 cough medicine 108  
 counselor 55  
 count v 165  
 counter 96, 98, 100, 142, 272  
 country 259, 315  
 couple 24  
 courier 99  
 courses 153  
 court 226  
 court case 180  
 court date 180  
 court officer 180  
 court official 180  
 courtroom 180  
 courtyard 58, 84  
 couscous 130  
 cousin 22  
 cow 185  
 cow's milk 136  
 crab 121, 295  
 cracked wheat 130  
 cradle 95  
 craft knife 82  
 crafts 275  
 cramp 239  
 cramps 44  
 cranberry 127  
 crane 187, 216, 292  
 crash barrier 195  
 crater 283  
 crayfish 121  
 cream 109, 137, 140, 157  
 cream cheese 136  
 cream pie 141  
 crease 225  
 credit card 96  
 creel 245  
 creeper 87  
 crème caramel 141  
 crème pâtisserie 140  
 crêpe 155  
 crescent moon 280  
 crew 241  
 crew hatch 281  
 cricket 225, 295  
 cricket ball 225  
 cricketer 225  
 crime 94  
 criminal 181  
 criminal record 181  
 crisp 127  
 crispbread 139, 156  
 crispier 67  
 crisps 113, 151  
 Croatia 316  
 crochet 277  
 crochet hook 277  
 crocodile 293  
 crocodile clip 167  
 croissant 156  
 crop 39, 183  
 crops 184  
 cross trainer 250  
 crossbar 207, 222, 235  
 cross-country skiing 247  
 crow 292  
 crown 50  
 crucible 166  
 crushed 132  
 crust 139, 282  
 cry v 25  
 crystal healing 55  
 Cuba 314  
 cube 164  
 cucumber 125  
 cuff 32, 45  
 cufflink 36  
 cultivate v 91  
 cultivator 182  
 cumin 132  
 curb 298  
 cured 118, 159, 143  
 curler 38  
 curling 247  
 curling tongs 38  
 curly 39  
 currant 129  
 current account 96  
 curry 158  
 curry powder 132  
 curtain 63, 254  
 curved 165  
 cushion 62  
 custard 140  
 customer 96, 104, 106, 152  
 customer service department 175  
 customer services 104  
 customs 212  
 customs house 216  
 cut 46  
 cut v 38, 79, 277  
 cuticle 15  
 cuts 119  
 cutting 91  
 cuttlefish 121  
 cycle lane 206  
 cycling 263  
 cylinder 164  
 cylinder head 202  
 cymbals 257  
 Cyprus 318  
 Czech Republic 316  
  
**D**  
 daffodil 111  
 dairy 107  
 dairy farm 183  
 dairy produce 136  
 daisy 110, 297  
 dam 300  
 dance 259  
 dance academy 169  
 dancer 191  
 dandelion 123, 297  
 dandruff 39  
 dark 41, 321  
 dark chocolate 113  
 darkroom 271  
 darn v 277  
 dartboard 273  
 darts 273  
 dashboard 201  
 date 129, 306  
 daughter 22  
 daughter-in-law 22  
 dawn 305  
 day 305, 306  
 dead ball line 221  
 deadhead v 91  
 deal v 273  
 debit card 96  
 decade 307  
 decay 50  
 December 306  
 deciduous 86  
 decimal 165  
 deck 214  
 deck chair 265  
 decking 85  
 decorating 82  
 decoration 141  
 decorator 82  
 deep end 239  
 deep-fried 159  
 deep sea fishing 245  
 deer 291  
 defense 181, 220  
 defendant 181  
 defender 223  
 defending zone 224  
 defrost v 67  
 degree 169  
 delay 209  
 deli 107  
 delicatessen 142  
 delivery 52, 98  
 deltoid 16  
 Democratic Republic of the Congo 317  
 Denmark 316  
 denomination 97  
 denominator 165  
 dental care 108  
 dental floss 50, 72  
 dental hygiene 72  
 dental x-ray 50  
 dentist 50, 189  
 dentist's chair 50  
 dentures 50  
 deodorant 73  
 deodorants 108  
 department 169  
 department store 105  
 departments 49  
 departure lounge 213  
 departures 213  
 deposit slips 96  
 depth 165  
 dermatology 49  
 descaled 121  
 desert 285  
 desiccated 129  
 designer 191, 277  
 desk 162, 172  
 desktop 177  
 desktop organizer 172  
 dessert 140, 153  
 destination 213  
 detached 58  
 detective 94  
 detergent 77  
 deuce 230  
 develop v 271  
 diabetes 44  
 diagonal 164  
 dial v 99  
 diameter 164  
 diamond 273, 288  
 diaphragm 19, 21  
 diaper 75  
 diaper rash cream 74  
 diarrhea 44, 109  
 diary 175  
 dice 272  
 dictionary 163  
 die v 26  
 diesel 199  
 diesel train 208

difficult 321  
dig v 90, 227  
digestive 19  
digital 269  
digital camera 270  
dilation 52  
dill 133  
dimensions 165  
dimple 15  
dining car 209  
dining room 64  
dinner 64, 158  
dinner plate 65  
diopter 51  
diploma 169  
dipstick 202  
direct current 60  
direct debit 96  
directions 260  
director 254  
directory assistance 99  
dirt bike 205  
dirty washing 76  
disabled parking 195  
discharged 48  
disconnected 99  
discus 234  
discuss v 163  
disembark v 217  
dishes 64, 65  
dishwasher 66  
disinfectant solution 51  
disk 176  
dispensary 108  
disposable 109  
disposable camera 270  
disposable diaper 30  
disposable razor 73  
dissertation 169  
distance 310  
distributor 203  
district 315  
dive 239  
dive v 238  
diver 238  
diversion 195  
divide v 165  
divided by 165  
divided highway 195  
dividends 97  
divider 173, 194  
divorce 26  
Diwali 27  
DJ 179  
Djibouti 317  
do not bend v 98  
dock 214, 216  
dock v 217  
doctor 45, 189  
doctorate 169  
documentary 178  
dog 290  
dog sledding 247  
doll 75  
doll's house 75  
dolphin 290  
dome 300  
domestic flight 212

domestic supply 60  
Dominica 314  
Dominican Republic 314  
dominoes 273  
donkey 185  
door 196, 198, 209  
door chain 59  
door knob 59  
door knocker 59  
door lock 200  
doorbell 59  
doormat 59  
dormer 58  
dorsal fin 294  
dosage 109  
double 151  
double bass 256  
double bassoon 257  
double bed 71  
double cream 137  
double room 100  
double-decker bus 196  
doubles 230  
dough 138  
Dover sole 120  
down 320  
downhill skiing 247  
download v 177  
dragonfly 295  
drain 61, 72, 299  
drain cock 61  
drainage 91  
draining board 67  
draw 223  
draw v 162  
drawer 66, 70, 172  
drawer unit 172  
drawing 275  
dress 31, 34  
dressage 243  
dressed 159  
dressed chicken 119  
dressing 47, 158  
dressing gown 31, 32  
dressing table 71  
dribble v 223  
dried flowers 111  
dried fruit 156  
drill 50  
drill v 79  
drill bit 78  
drill bits 80  
drinking cup 75  
drinking fountain 262  
drinks 107, 144, 156  
drip 53  
drive v 195, 233  
driver 196  
driver's cab 208  
driver's seat 196  
driveshaft 202  
drop anchor v 217  
drop cloth 83  
dropper 109, 167  
drops 109  
dropshot 230  
drown v 239

drugstore 108  
drum 258  
drum kit 258  
drummer 258  
dry 39, 41, 130, 145, 286, 321  
dry v 76  
dry cleaners 115  
dry dock 217  
duck 119, 185  
duck egg 137  
duckling 185  
duffel coat 31  
dugout 229  
dumb bell 251  
dump truck 187  
dunk v 227  
duodenum 18  
dusk 305  
dust v 77  
dustcloth 77  
dustpan 77  
duty-free shop 213  
DVD disk 269  
DVD player 268  
dyed 39  
dynamo 207

E

eagle 292  
ear 14  
early 305, 320  
earring 36  
Earth 280, 282  
earthenware dish 69  
earthing 60  
earthquake 283  
easel 174, 274  
east 312  
East Timor 319  
Easter 27  
easy 321  
easy cook 130  
eat v 64  
eat-in 154  
eating 75  
eau de toilette 41  
eaves 58  
éclair 140  
eclipse 280  
economics 169  
economy class 211  
Ecuador 315  
eczema 44  
Edam 142  
edge 246  
editor 191  
eel 294  
egg cup 65, 137  
eggplant 125  
eggs 20, 137  
egg white 137  
Egypt 317  
eight 308  
eight hundred 308  
eighteen 308  
eighteenth 309  
eighth 309

eightieth 309  
eighty 308  
ejaculatory duct 21  
El Salvador 314  
elbow 13  
electric blanket 71  
electric drill 78  
electric guitar 258  
electric razor 73  
electric shock 46  
electric train 208  
electrical goods 105, 107  
electrician 188  
electricity 60  
electricity meter 60  
elephant 291  
elevator 59, 100, 104  
eleven 308  
eleventh 309  
elm 296  
email 98, 177  
email account 177  
email address 177  
embarrassed 25  
embossed paper 83  
embroidery 277  
embryo 52  
emerald 288  
emergency 46  
emergency exit 210  
emergency lever 209  
emergency phone 195  
emergency room 48  
emergency services 94  
emigrate v 26  
emotions 25  
employee 24  
employer 24  
empty 321  
emulsion 83  
enamel 50  
encore 255  
encyclopedia 163  
end 321  
end zone 220  
endive 123  
endline 226  
endocrine 19  
endocrinology 49  
engaged/busy 99  
engaged couple 24  
engine 202, 204, 208, 210  
engine room 214  
engineering 169  
English breakfast 157  
English horn 257  
english mustard 135  
engraving 275  
enlarge v 172  
enlargement 271  
enquiries 168  
ENT 49  
entrance 59  
entrance fee 260  
envelope 98, 173  
environment 280  
epidural 52  
epiglottis 19

epilepsy 44  
episiotomy 52  
equals 165  
equation 165  
equator 283  
equipment 233, 238  
equipment 165  
Equatorial Guinea 317  
equity 97  
Eritrea 317  
erupt v 283  
escalator 104  
esophagus 19  
espresso 148  
essay 163  
essential oils 55  
Estonia 316  
estuary 285  
Ethiopia 317  
eucalyptus 296  
Europe 316  
evening 305  
evening dress 34  
events 243, 247  
evergreen 86  
evidence 181  
examination 163  
excess baggage 212  
exchange rate 97  
excited 25  
excuse me 322  
executive 174  
exercise bike 250  
exercises 251  
exfoliate v 41  
exhaust pipe 203, 204  
exhibit v 261  
exhibition 261  
exit 210  
exit ramp 194  
exosphere 286  
expectant 52  
experiment 166  
expiration date 109  
exposure 271  
extend v 251  
extension 58  
extension lead 78  
exterior 198  
extra time 223  
extraction 50  
extractor 66  
eye 14, 51, 244, 276  
eye shadow 40  
eye test 51  
eyebrow 14, 51  
eyebrow brush 40  
eyebrow pencil 40  
eyecup 269  
eyelash 14, 51  
eyelet 37  
eyelid 51  
eyeliner 40  
eyepiece 167

F

fabric 277  
fabric conditioner 76

- face 14  
 face cream 73  
 face mask 225  
 face pack 41  
 face powder 40  
 face-off circle 224  
 facial 41  
 factory 299  
 faint v 25, 44  
 fair 41  
 fairground 262  
 fairway 232  
 falcon 292  
 Falkland Islands 315  
 fall 237  
 fall in love v 26  
 fallopian tube 20  
 family 22  
 famous ruin 261  
 fan 60, 202  
 fan belt 203  
 fans 258  
 far 320  
 fare 197, 209  
 farm 182, 183, 184  
 farmer 182, 189  
 farmhouse 182  
 farmland 182  
 farmyard 182  
 farsightedness 51  
 fashion 277  
 fast 321  
 fast food 154  
 fast forward 269  
 fastening 37  
 fat 119, 321  
 fat free 137  
 fat-free milk 136  
 father 22  
 father-in-law 23  
 faucet 61, 66  
 fault 230  
 fax 98, 172  
 fax machine 172  
 fava bean 122  
 feather 293  
 feature film 269  
 February 306  
 feed v 183  
 feijoa 128  
 female 12, 20  
 feminine hygiene 108  
 femur 17  
 fence 85, 182, 243  
 fencing 249  
 feng shui 55  
 fennel 122, 133  
 fennel seeds 133  
 fenugreek 132  
 fern 86  
 ferry 215, 216  
 ferry terminal 216  
 fertilization 20  
 fertilize v 91  
 fertilizer 91  
 festivals 27  
 fetus 52  
 fever 44  
 fiancé 24  
 fiancée 24  
 fiber 127  
 fibula 17  
 field 182, 222, 225, 228, 234  
 field v 225, 229  
 field hockey 224  
 fifteen 308  
 fifteenth 309  
 fifth 309  
 fiftieth 309  
 fifty 308  
 fifty-five thousand, five hundred 309  
 fifty thousand 309  
 fig 129  
 fighter plane 211  
 figure skating 247  
 Fiji 319  
 filament 60  
 file 81, 172, 177  
 filing cabinet 172  
 fill v 82  
 filler 83  
 fillet 119, 121  
 filleted 121  
 filling 50, 140, 155  
 film 271  
 film set 179  
 film spool 271  
 filo pastry 140  
 filter 270  
 filter coffee 148  
 filter paper 167  
 fin 210, 239  
 finance 97  
 financial advisor 97  
 fingerprint 94  
 finial 300  
 finishing line 234  
 Finland 316  
 fire 95  
 fire alarm 95  
 fire department 95  
 fire engine 95  
 fire escape 95  
 fire extinguisher 95  
 fire fighters 95  
 fire station 95  
 firelighter 266  
 fireman 189  
 fireplace 63  
 firm 124  
 first 309  
 first aid 47  
 first aid box 47  
 first floor 104  
 first night 254  
 fish 107, 120, 294  
 fish and chips 155  
 fish farm 183  
 fisherman 189  
 fishhook 244  
 fishing 244, 245  
 fishing boat 217  
 fishing permit 245  
 fishing port 217  
 fishing rod 244  
 fishmonger 188  
 fishmonger's 114, 120  
 fist 15, 237  
 fitness 250  
 five 308  
 five hundred 308  
 flag 221, 232  
 flageolet beans 131  
 flakes 132  
 flamingo 292  
 flan 142  
 flan dish 69  
 flare 240  
 flash 270  
 flash gun 270  
 flashlight 267  
 flask 166  
 flat 59, 256  
 flatbread 139  
 flat race 243  
 flat wood bit 80  
 flavored oil 134  
 flax 184  
 fleece 74  
 flesh 124, 127, 129  
 flex v 251  
 flight attendant 210  
 flight number 213  
 flint 288  
 flipchart 174  
 flip-flop 37  
 flipper 290  
 float 238, 244  
 float ball 61  
 flock 183  
 flood 287  
 floor 58, 62, 71  
 floor exercises 235  
 floor plan 261  
 florentine 141  
 floret 122  
 florist 110, 188  
 floss v 50  
 flours 138  
 flower 297  
 flowerbed 85, 90  
 flowering plant 297  
 flowering shrub 87  
 flowers 110  
 flu 44  
 flute 139, 257  
 fly 244, 295  
 fly v 211  
 fly fishing 245  
 flyover 194  
 flysheet 266  
 foal 185  
 focus v 271  
 focusing knob 167  
 fog 287  
 foil 249  
 folder 177  
 foliage 110  
 folk music 259  
 follicle 20  
 font 177  
 food 118, 130, 149  
 food processor 66  
 foot 12, 15, 310  
 football 220  
 football field 220  
 football player 220  
 footboard 71  
 footpath 262  
 footstrap 241  
 for 320  
 forceps 53, 167  
 forearm 12  
 forecourt 199  
 forehand 231  
 forehead 14  
 foreign currency 97  
 flash gun 270  
 foreskin 21  
 forest 285  
 fork 65, 88, 153, 207  
 fork-lift truck 186, 216  
 formal garden 84  
 formal gardens 262  
 fortieth 309  
 fortnight 307  
 forty 308  
 forty minutes 304  
 forward 222  
 foul 222, 226  
 foul ball 228  
 foul line 229  
 foundation 40  
 fountain 85  
 four 308  
 four hundred 308  
 four-door 200  
 fourteen 308  
 fourteenth 309  
 fourth 309  
 four-wheel drive 199  
 fox 290  
 foxglove 297  
 fraction 165  
 fracture 46  
 fragile 98  
 fragranced 130  
 frame 51, 62, 206, 267  
 frame counter 270  
 France 316  
 freckle 15  
 free 321  
 free kick 222  
 free range 118  
 free weights 250  
 freesia 110  
 free-throw line 226  
 freeze 287  
 freeze v 67  
 freezer 67  
 freight train 208  
 freighter 215  
 French bean 122  
 french fries 154  
 French Guiana 315  
 French horn 257  
 french mustard 135  
 french pleat 39  
 French toast 157  
 frequency 179  
 fresh 121, 127, 130  
 fresh cheese 136  
 freshwater fishing 245  
 fret 258  
 fretsaw 81  
 Friday 306  
 fried 159  
 fried chicken 155  
 fried egg 157  
 fried noodles 158  
 friend 24  
 frieze 301  
 frog 294  
 from 320  
 front crawl 239  
 front door 58  
 front wheel 196  
 frontal 16  
 frost 287  
 froth 148  
 frown 25  
 frozen 121, 124  
 frozen food 107  
 frozen yogurt 137  
 fruit 107, 126, 128  
 fruit bread 139  
 fruit cake 140  
 fruit farm 183  
 fruit gum 113  
 fruit juice 127, 156  
 fruit salad 157  
 fruit tart 140  
 fruit yogurt 157  
 fry v 67  
 frying pan 69  
 fuel gauge 201  
 fuel tank 204  
 full 64, 266, 321  
 full board 101  
 full moon 280  
 fumble 220  
 funeral 26  
 funnel 166, 214  
 furniture store 115  
 furrow 183  
 fuse 60  
 fuse box 60, 203  
 fuselage 210  
 futon 71  
 G  
 gable 300  
 Gabon 317  
 Galapagos Islands 315  
 galaxy 280  
 gale 286  
 galley 214  
 gallon 311  
 gallop 243  
 galvanized 79  
 Gambia 317  
 game 119, 230, 273  
 game show 178  
 games 272  
 gangway 214  
 garage 58, 199  
 garden 84  
 garden center 115  
 garden features 84



- garden pea 122  
 garden plants 86  
 garden styles 84  
 garden tools 88  
 gardener 188  
 gardening 90  
 gardening gloves 89  
 gardens 261  
 garland 111  
 garlic 125, 132  
 garlic press 68  
 garnet 288  
 garter 35  
 gas burner 61  
 gasket 61  
 gasoline 199  
 gas pump 199  
 gas station 199  
 gas tank 203  
 gate 85, 182, 247  
 gate number 213  
 gauze 47, 167  
 gear lever 207  
 gearbox 202, 204  
 gears 206  
 gearstick 201  
 gel 38, 109  
 gems 288  
 generation 23  
 generator 60  
 genitals 12  
 geography 162  
 geometry 165  
 Georgia 318  
 gerbera 110  
 Germany 316  
 get a job v 26  
 get married v 26  
 get up v 71  
 geyser 285  
 Ghana 317  
 giant slalom 247  
 gift shop 114  
 gill 294  
 gin 145  
 gin and tonic 151  
 ginger 39, 125, 133  
 giraffe 291  
 girder 186  
 girl 23  
 girlfriend 24  
 girth 242  
 glacier 284  
 gladiolus 110  
 gland 19  
 glass 69, 152  
 glass bottle 166  
 glass rod 167  
 glasses 51, 150  
 glassware 64  
 glaze v 139  
 glider 211, 248  
 gliding 248  
 gloss 83, 271  
 glove 224, 233, 236, 246  
 gloves 36  
 glue 275  
 glue gun 78
- gneiss 288  
 go to bed v 71  
 go to sleep v 71  
 goal 221, 223, 224  
 goal area 223  
 goal line 220, 223, 224  
 goalkeeper 222, 224  
 goalpost 220, 222  
 goat 185  
 goat's cheese 142  
 goat's milk 136  
 goggles 238, 247  
 going out 75  
 gold 235, 289  
 goldfish 294  
 golf 232  
 golf bag 233  
 golf ball 233  
 golf cart 233  
 golf clubs 233  
 golf course 232  
 golf shoe 233  
 golfer 232  
 gong 257  
 good 321  
 good afternoon 322  
 good evening 322  
 good morning 322  
 good night 322  
 goodbye 322  
 goose 119, 293  
 goose egg 137  
 gooseberry 127  
 gorge 284  
 gorilla 291  
 gothic 301  
 grade 163  
 graduate 169  
 graduate v 26  
 graduation ceremony 169  
 graft v 91  
 grains 130  
 gram 310  
 granary bread 139  
 grandchildren 23  
 granddaughter 22  
 grandfather 22  
 grandmother 22  
 grandparents 23  
 grandson 22  
 granite 288  
 grape juice 144  
 grapefruit 126  
 grapeseed oil 134  
 graphite 289  
 grass 86, 262  
 grass bag 88  
 grasshopper 295  
 grassland 285  
 grate v 67  
 grated cheese 136  
 grater 68  
 gratin dish 69  
 gravel 88  
 gravity 280  
 gray 39, 274  
 graze 46
- greasy 39  
 Greece 316  
 green 129, 232, 274  
 green olive 143  
 green onion 125  
 green peas 131  
 green salad 158  
 green tea 149  
 greengrocer 188  
 greengrocer's 114  
 greenhouse 85  
 Greenland 314  
 Grenada 314  
 grill v 67  
 grill pan 69  
 grilled 159  
 groceries 105, 106  
 grocer's 114  
 groin 12  
 groom 243  
 ground 132  
 ground coffee 144  
 ground cover 87  
 ground floor 104  
 ground sheet 267  
 group therapy 55  
 grout 83  
 guard 236  
 Guatemala 314  
 guava 128  
 guest 64, 100  
 guidebook 260  
 guided tour 260  
 guilty 181  
 Guinea 317  
 Guinea-Bissau 317  
 guitarist 258  
 gull 292  
 gum 50  
 gun 94  
 gutter 58, 299  
 guy rope 266  
 Guyana 315  
 gym 101, 250  
 gym machine 250  
 gymnast 235  
 gymnastics 235  
 gynecologist 52  
 gynecology 49  
 gypsophila 110
- H**  
 hacksaw 81  
 haddock 120  
 hemorrhage 46  
 hail 286  
 hair 14, 38  
 hair dye 40  
 hairband 38  
 hairdresser 38, 188  
 hairdryer 38  
 hairpin 38  
 hairspray 38  
 hairtie 39  
 Haiti 314  
 half an hour 304  
 half board 101  
 half time 223
- half-liter 311  
 halibut fillets 120  
 Halloween 27  
 hallway 59  
 halter 243  
 halter neck 35  
 ham 119, 143, 156  
 hammer 80  
 hammer v 79  
 hammock 266  
 hamper 263  
 hamster 290  
 hamstring 16  
 hand 13, 15  
 hand drill 81  
 hand fork 89  
 hand luggage 211, 213  
 hand rail 59  
 hand saw 89  
 hand towel 73  
 handbag 37  
 handbrake 203  
 handcuffs 94  
 handicap 233  
 handkerchief 36  
 handle 36, 88, 106, 187, 200, 230  
 handlebar 207  
 handles 37  
 handrail 196  
 handsaw 80  
 handset 99  
 hang v 82  
 hang-glider 248  
 hang-gliding 248  
 hanging basket 84  
 hanging file 173  
 happy 25  
 harbor 217  
 harbor master 217  
 hard 129, 321  
 hard candy 113  
 hard cheese 136  
 hard drive 176  
 hard hat 186  
 hard shoulder 194  
 hardboard 79  
 hardware 176  
 hardware store 114  
 hardwood 79  
 haricot beans 131  
 harness race 243  
 harp 256  
 harvest v 91, 183  
 hat 36  
 hatchback 199  
 have a baby v 26  
 Hawaii 314  
 hay 184  
 hayfever 44  
 hazard 195  
 hazard lights 201  
 hazelnut 129  
 hazelnut oil 134  
 head 12, 19, 81, 230  
 head v 222  
 head injury 46  
 head office 175
- headache 44  
 headboard 70  
 headlight 198, 205  
 headphones 268  
 headrest 200  
 headsail 240  
 health 44  
 health center 168  
 health food shop 115  
 heart 18, 119, 122, 273  
 heart attack 44  
 heater 60  
 heater controls 201  
 heather 297  
 heating element 61  
 heavy 321  
 heavy metal 259  
 hedge 85, 90, 182  
 hedgehog 290  
 heel 13, 15, 37  
 height 165  
 height bar 45  
 helicopter 211  
 hello 322  
 helmet 95, 204, 206, 220, 224, 228  
 hem 34  
 hematite 289  
 hen's egg 137  
 herb 55, 86, 133, 134  
 herbaceous border 85  
 herbal remedies 108  
 herbal tea 149  
 herbalism 55  
 herb garden 84  
 herbicide 183  
 herbs and spices 132  
 herd 183  
 hexagon 164  
 hi-fi system 268  
 high 321  
 high chair 75  
 high dive 239  
 high heel shoe 37  
 high jump 235  
 high speed train 208  
 highlights 39  
 hiking 263  
 hill 284  
 Himalayas 313  
 hip 12  
 hippopotamus 291  
 historic building 261  
 history 162  
 history of art 169  
 hit v 224  
 hockey 224  
 hockey stick 224  
 hoe 88  
 hold 215, 237  
 holdall 37  
 hole 232  
 hole in one 233  
 hole punch 173  
 holiday 212  
 holiday brochure 212  
 holly 296  
 home 58

- home delivery 154  
home entertainment 268  
home furnishings 105  
home plate 228  
homeopathy 55  
homework 163  
homogenized 137  
Honduras 314  
honeycomb 135  
honeymoon 26  
honeysuckle 297  
hood 31, 75  
hoof 242, 291  
hook 187, 276  
hoop 226, 277  
horizontal bar 235  
hormone 20  
horn 201, 204, 291  
horror film 255  
horse 185, 235, 242  
horse race 243  
horseback riding 242, 263  
horseradish 125  
horseshoe 242  
hose 95  
hose reel 89  
hosepipe 89  
hospital 48  
hot 124, 286, 321  
hot chocolate 144, 156  
hot dog 155  
hot drinks 144  
hot faucet 72  
hot-air balloon 211  
hotel 100, 264  
hot-water bottle 70  
hour 304  
hour hand 304  
house 58  
household products 107  
hovercraft 215  
hub 206  
hubcap 202  
hull 214, 240  
humerus 17  
humid 286  
hummingbird 292  
hump 291  
hundred 308  
hundred and ten 308  
hundred thousand 308  
hundredth 309  
Hungary 316  
hungry 64  
hurdles 235  
hurricane 287  
husband 22  
husk 130  
hydrant 95  
hydrofoil 215  
hydrotherapy 55  
hypnotherapy 55  
hypoallergenic 41  
hypotenuse 164
- I  
ice 120, 287  
ice and lemon 151  
ice bucket 150  
ice climbing 247  
ice cream 137, 149  
ice cube 151  
iced coffee 148  
iced tea 149  
ice hockey 224  
ice hockey player 224  
ice hockey rink 224  
ice maker 67  
ice skate 224  
ice skating 247  
icicle 287  
icing 141  
icon 177  
identity badge 189  
identification tag 53  
igneous 288  
ignition 200  
iguana 293  
illness 44  
immigration 212  
impotent 20  
in 320  
in brine 143  
in front of 320  
in oil 143  
in sauce 159  
in syrup 159  
inbox 177  
inch 310  
incisor 50  
incubator 53  
index finger 15  
India 318  
Indian Ocean 312  
indicator 198, 204  
indigo 274  
Indonesia 319  
induce labor v 53  
industrial complex 299  
infant carrier 75  
infection 44  
infertile 20  
infield 228  
inflatable dinghy 215  
information 261  
information screen 213  
in-goal area 221  
inhaler 44, 109  
injection 48  
injury 46  
ink 275  
ink pad 173  
inlet 61  
inner core 282  
inner tube 207  
inning 228  
innocent 181  
inoculation 45  
insect repellent 108, 267  
inside 320  
inside lane 194  
insomnia 71  
inspector 94  
install v 177  
instant camera 270  
instep 15  
instructions 109  
instruments 256, 258  
insulating tape 81  
insulation 61  
insulin 109  
insurance 203  
intensive care unit 48  
inter-city train 209  
intercom 59  
intercostal 16  
intercourse 20  
interest rate 96  
interior 200  
internal systems 60  
international flight 212  
internet 177  
intersection 298  
interval 254  
interviewer 179  
into 320  
in-tray 172  
invertibrates 295  
investigation 94  
investment 97  
ionosphere 286  
Iran 318  
Iraq 318  
Ireland 316  
iris 51, 110  
iron 76, 109, 233, 289  
iron v 76  
ironing board 76  
island 282  
Israel 318  
Italy 316  
itinerary 260  
IUD 21  
Ivory Coast 317
- J  
jack 203, 273  
jacket 32, 34  
jade 288  
jail cell 94  
jam 134, 156  
Jamaica 314  
January 306  
Japan 318  
Japanese teacup 64  
Japanese floor cushion 64, 152  
Japanese horseradish 124  
Japanese low table 152  
jar 134, 311  
javelin 234  
jaw 14, 17  
jazz 259  
jeans 31  
jelly bean 113  
jellyfish 295  
Jerusalem artichoke 125  
jet 288  
jet skiing 241  
jetty 217  
jeweler 188  
jeweler's 114  
jewelry 36  
jewelry box 36  
jewelry making 275  
jigsaw puzzle 78  
jigsaw puzzle 273  
jodpurs 242  
jog on the spot 251  
jogging 251, 263  
joint 17, 119  
joker 273  
Jordan 318  
journal 168  
journalist 190  
judge 180  
judo 236  
juices and milkshakes 149  
juicy 127  
July 306  
jump 237, 243  
jump v 227  
jump ball 226  
junction 194  
June 306  
Jupiter 280  
jury 180  
jury box 180
- K  
kale 123  
Kaliningrad 316  
kangaroo 291  
karate 236  
kayak 241  
Kazakhstan 318  
kebab 155, 158  
keel 214  
keep net 244  
kendo 236  
Kenya 317  
kernel 122, 129, 130  
ketchup 135  
kettle 66  
kettledrum 257  
key 59, 80, 176, 207  
keyboard 172, 176, 258  
keypad 97, 99  
kick 237, 239  
kick v 221, 223  
kickboxing 236  
kickstand 207  
kid 185  
kidney 18, 119  
kilogram 310  
kilometer 310  
kimono 35  
king 272, 273  
king prawn 121  
kippers 157  
kitchen 66, 152  
kitchen knife 68  
kitchenware 68, 105  
kitten 290  
kiwifruit 128  
knead v 138  
knee 12  
knee pad 205  
knee support 227  
kneecap 17  
knee-length 34  
knickers 35  
knife 65, 80  
knife sharpener 68, 118  
knight 272  
knitting 277  
knitting needle 277  
knock out 237  
knuckle 15  
koala 291  
kohlrabi 123  
koi carp 294  
kumquat 126  
kung fu 236  
Kuwait 318  
Kyrgyzstan 318
- L  
label 172  
labels 89  
labia 20  
laboratory 166  
lace 35, 37  
lace bobbin 277  
lace making 277  
lace-up 37  
lacrosse 249  
lactose 137  
ladder 95, 186  
ladle 68  
ladybug 295  
lake 285  
lamb 118, 185  
lamp 62, 207, 217  
land 282  
land v 211  
landing 59  
landing gear 210  
landing net 244  
landlord 58  
landscape 271, 284  
landscape v 91  
lane 234, 238  
languages 162  
Laos 318  
lapel 32  
laptop 175  
larch 296  
large 321  
large intestine 18  
larynx 19  
last week 307  
lat 16  
late 305  
later 304  
latitude 283  
Latvia 316  
laugh v 25  
launch 281  
launch pad 281  
laundrette 115  
laundry 76  
laundry basket 76  
laundry service 101  
lava 283  
law 169, 180  
lawn 85, 90  
lawn rake 88  
lawnmower 88, 90

lawyer 180, 190  
 lawyer's office 180  
 laxative 109  
 lead singer 258  
 leaded 199  
 leaf 122, 296  
 leaflets 96  
 league 223  
 lean meat 118  
 learn v 163  
 leather shoe 37  
 leather shoes 32  
 leathers 205  
 Lebanon 318  
 lecture theater 169  
 lecturer 169  
 leek 125  
 left 260  
 left field 228  
 left-hand drive 201  
 leg 12, 119  
 leg pad 225  
 leg press 251  
 legal advice 180  
 legal department 175  
 leggings 31  
 legumes 130  
 leisure 258, 254, 264  
 lemon 126  
 lemon curd 134  
 lemon grass 133  
 lemon sole 120  
 lemonade 144  
 length 165, 310  
 lens 270  
 lens (eye) 51  
 lens (glasses) 51  
 lens cap 270  
 lens case 51  
 Lesotho 317  
 lesson 163  
 let! 231  
 letter 98  
 letterbox 58, 99  
 letterhead 173  
 lettuce 123  
 lever 61, 150  
 lever arch file 173  
 Liberia 317  
 librarian 168, 190  
 library 168, 299  
 library card 168  
 Libya 317  
 license plate 198  
 licorice 113  
 lid 61, 66  
 Liechtenstein 316  
 life events 26  
 life jacket 240  
 life raft 240  
 lifeboat 214  
 lifebuoy 240  
 lifeguard 239, 265  
 lifeguard tower 265  
 ligament 17  
 light 178, 321  
 light a fire v 266  
 light aircraft 211

light bulb 60  
 lighter 112  
 lighthouse 217  
 lighting 105  
 lightmeter 270  
 lightning 287  
 lights 94  
 lights switch 201  
 lily 110  
 lima beans 131  
 lime 126, 296  
 limestone 288  
 limousine 199  
 line 244  
 line judge 220  
 line of play 233  
 linen 105, 277  
 linen basket 76  
 lines 165  
 linesman 223, 230  
 lingerie 35, 105  
 lining 32  
 lining paper 83  
 link 36  
 lintel 186  
 lion 291  
 lip 14  
 lip brush 40  
 lip gloss 40  
 lip liner 40  
 lipstick 40  
 liqueur 145  
 liquid 77  
 liquid dispenser 311  
 liquid measure 311  
 liquor store 115  
 literature 162, 169  
 Lithuania 316  
 liter 311  
 little finger 15  
 little toe 15  
 live 60, 178  
 live rail 209  
 liver 18, 118  
 livestock 183, 185  
 living room 62  
 lizard 293  
 load v 76  
 loaf 139  
 loan 96, 168  
 loans desk 168  
 lob 230  
 lobby 100, 255  
 lobster 121, 295  
 lock 59, 207  
 lockers 239  
 log on v 177  
 loganberry 127  
 logo 31  
 loin 121  
 lollipop 113  
 long 32  
 long jump 235  
 long wave 179  
 long-grain 130  
 long-handled shears 88  
 longitude 283  
 loofah 73

loom 277  
 loose leaf tea 144  
 lorry 194  
 lorry driver 190  
 lose v 273  
 loser 273  
 lottery tickets 112  
 love 230  
 low 321  
 luge 247  
 luggage 100, 198, 213  
 luggage department 104  
 luggage hold 196  
 luggage rack 209  
 lumbar vertebrae 17  
 lunar module 281  
 lunch 64  
 lunch box 154  
 lung 18  
 lunge 251  
 lupins 297  
 lure 244  
 Luxembourg 316  
 lychee 128  
 lymphatic 19  
 lyrics 259

**M**

macadamia 129  
 mac 132  
 Macedonia 316  
 machine gun 189  
 machinery 187  
 mackerel 120  
 macramé 277  
 Madagascar 317  
 magazine 107, 112  
 magazines 107  
 magma 283  
 magnesium 109  
 magnet 167  
 maid service 101  
 mailbag 98, 190  
 mailbox 99  
 mailman 98, 190  
 main course 153  
 mainsail 240  
 make a will v 26  
 make friends v 26  
 make the bed v 71  
 makeup 40  
 making bread 138  
 malachite 288  
 Malawi 317  
 Malaysia 318  
 Maldives 318  
 male 12, 21  
 Mali 317  
 mallet 78, 275  
 malt vinegar 135  
 Malta 316  
 malted drink 144  
 mammals 290  
 man 23  
 manager 24, 174  
 managing director 175  
 manchego 142  
 mane 242, 291

mango 128  
 manhole 299  
 manicure 41  
 mantelpiece 63  
 mantle 282  
 manual 200  
 map 195, 261  
 maple 296  
 maple syrup 134  
 maracas 257  
 marathon 234  
 marble 288  
 March 306  
 margarine 137  
 marina 217  
 marinated 143, 159  
 marine fishing 245  
 marjoram 133  
 mark v 227  
 market 115  
 marketing department 175  
 marmalade 134, 156  
 marrow 124  
 Mars 280  
 marshmallow 113  
 martial arts 237  
 martini 151  
 marzipan 141  
 mascara 40  
 mashed 159  
 masher 68  
 mask 189, 228, 236, 239, 249  
 masking tape 83  
 masonry bit 80  
 massage 54  
 mast 240  
 masters 169  
 mat 54, 83, 235, 271  
 match 230  
 matches 112  
 material 276  
 materials 79, 187  
 maternity 49  
 maternity ward 48  
 math 162, 164  
 mattress 70, 74  
 Mauritiana 317  
 Mauritius 317  
 May 306  
 maybe 322  
 mayonnaise 135  
 MDF 79  
 meadow 285  
 meal 64  
 measles 44  
 measure 150, 151  
 measure v 310  
 measurements 165  
 measuring cup 69, 311  
 measuring spoon 109  
 meat 119  
 meat and poultry 106  
 meat tenderizer 68  
 meatballs 158  
 meathook 118  
 mechanic 188, 203  
 mechanical digger 187

mechanics 202  
 medals 235  
 media 178  
 medical examination 45  
 medication 109  
 medicine 109, 169  
 medicine cabinet 72  
 meditation 54  
 Mediterranean Sea 313  
 medium wave 179  
 meeting 174  
 meeting room 174  
 melody 259  
 melon 127  
 memory 176  
 men's clothing 32  
 men's wear 105  
 menstruation 20  
 menu 148, 153, 154  
 menubar 177  
 mercury 289  
 Mercury 280  
 meringue 140  
 mesosphere 286  
 messages 100  
 metacarpal 17  
 metal 79  
 metal bit 80  
 metals 289  
 metamorphic 288  
 metatarsal 17  
 meteor 280  
 meter 310  
 Mexico 314  
 mica 289  
 microlight 211  
 microphone 179, 258  
 microscope 167  
 microwave oven 66  
 midday 305  
 middle finger 15  
 middle lane 194  
 midnight 305  
 midwife 53  
 migraine 44  
 mile 310  
 milk 136, 156  
 milk v 183  
 milk carton 136  
 milk chocolate 113  
 milkshake 137  
 millennium 307  
 millet 130  
 milligram 310  
 milliliter 311  
 millimeter 310  
 mince 119  
 mineral 144, 289  
 mini bar 101  
 mini disk recorder 268  
 minibus 197  
 mint 113, 133  
 mint tea 149  
 minus 165  
 minute 304  
 minute hand 304  
 minutes 174  
 mirror 40, 63, 71, 167



- miscarriage 52  
 Miss 23  
 missile 211  
 mist 287  
 miter block 81  
 mitt 228  
 mittens 30  
 mix v 67, 138  
 mixed salad 158  
 mixing bowl 66, 69  
 mixing desk 179  
 moat 300  
 mobile 74  
 model 169, 190  
 model making 275  
 modeling tool 275  
 modem 176  
 moisturizer 41  
 molar 50  
 molding 63  
 Moldova 316  
 mole 14  
 Monaco 316  
 Monday 306  
 money 97  
 Mongolia 318  
 monitor 53, 172, 176  
 monkey 291  
 monkfish 120  
 monopoly 272  
 monorail 208  
 monsoon 287  
 month 306  
 monthly 307  
 monument 261  
 Moon 280  
 moonstone 288  
 moor v 217  
 mooring 217  
 mop 77  
 morning 305  
 Morocco 317  
 mortar 68, 167, 187  
 mortgage 96  
 mosque 300  
 mosquito 295  
 mosquito net 267  
 moth 295  
 mother 22  
 mother-in-law 23  
 motor 88  
 motor racing 249  
 motorbike 204  
 motorbike racing 249  
 motorcross 249  
 motorway 194  
 mountain 284  
 mountain bike 206  
 mountain range 282  
 mouse 176, 290  
 mousse 141  
 mouth 14  
 mouth guard 237  
 mouthwash 72  
 move 273  
 movie 260  
 movie theater 299  
 move v 90
- Mozambique 317  
 mozzarella 142  
 MP3 player 268  
 Mr. 23  
 Mrs. 23  
 mudguard 205  
 muffin 140  
 muffin tray 69  
 mug 65  
 mulch v 91  
 multiply v 165  
 multivitamins 109  
 mumps 44  
 mung beans 131  
 muscles 16  
 museum 261  
 mushroom 125  
 music 162  
 music school 169  
 musical 255  
 musical score 255  
 musical styles 259  
 musician 191  
 mussel 121, 295  
 mustard 155  
 mustard seed 131  
 Myanmar 318
- N**  
 naan bread 139  
 nail 15, 80  
 nail clippers 41  
 nail file 41  
 nail scissors 41  
 nail varnish 41  
 nail varnish remover 41  
 Namibia 317  
 nape 13  
 napkin 65, 152  
 napkin ring 65  
 narrow 321  
 nation 315  
 national park 261  
 natural 256  
 natural fiber 31  
 naturopathy 55  
 nausea 44  
 navel 12  
 navigate v 240  
 near 320  
 nearsightedness 51  
 nebula 280  
 neck 12, 258  
 neck brace 46  
 neckline 34  
 nectarine 126  
 needle 109, 276  
 needle plate 276  
 needle-nose pliers 80  
 needlepoint 277  
 negative 271  
 negative electrode 167  
 negligée 35  
 neighbor 24  
 neoclassical 301  
 Nepal 318  
 nephew 23
- Neptune 280  
 nerve 19, 50  
 nervous 19, 25  
 net 217, 222, 226, 227, 231  
 net v 245  
 net curtain 63  
 Netherlands 316  
 nettle 297  
 network 176  
 neurology 49  
 neutral 60  
 neutral zone 224  
 new 321  
 new moon 280  
 new potato 124  
 New Year 27  
 New Zealand 319  
 newborn baby 53  
 news 178  
 news anchor 179, 191  
 newspaper 112  
 newsstand 112  
 next week 306  
 nib 163  
 Nicaragua 314  
 nickel 289  
 niece 23  
 Niger 317  
 Nigeria 317  
 night 305  
 nightdress 35  
 nightie 31  
 nightwear 31  
 nine 308  
 nine hundred 308  
 nineteen 308  
 nineteen hundred 307  
 nineteen hundred and one 307  
 nineteen ten 307  
 nineteenth 309  
 ninetieth 309  
 ninety 308  
 ninth 309  
 nipple 12  
 no 322  
 no entry 195  
 no right turn 195  
 no stopping 195  
 nonsmoking section 152  
 nonstick 69  
 noodles 158  
 normal 39  
 north 312  
 North and Central America 314  
 North Korea 318  
 North pole 283  
 North Sea 312  
 Northern Hemisphere 283  
 Norway 316  
 nose 14, 210  
 nose clip 238  
 noseband 242  
 nosebleed 44  
 nosewheel 210  
 nostril 14  
 notation 256  
 note 97, 256
- note pad 173  
 notebook 163, 172  
 notes 175, 191  
 notice board 173  
 notions 105  
 nougat 113  
 November 306  
 now 304  
 nozzle 89  
 number 226  
 numbers 308  
 numerator 165  
 nurse 45, 48, 52, 189  
 nursery 74  
 nursing 53  
 nursing bra 53  
 nut 80  
 nutmeg 132  
 nuts 151  
 nuts and dried fruit 129  
 nylon 277
- O**  
 oak 296  
 oar 241  
 oatmeal 157  
 oats 130  
 objective lens 167  
 oboe 257  
 obsidian 288  
 obstetrician 52  
 occupations 188, 190  
 occupied 321  
 ocean 282  
 ocean liner 215  
 octagon 164  
 October 306  
 octopus 121, 295  
 odometer 201  
 offal 118  
 offers 106  
 office 24, 172, 174  
 office building 298  
 office equipment 172  
 office supplies 173  
 off-piste 247  
 off-side 223  
 oil 142, 199  
 oil paints 274  
 oil tank 204  
 oil tanker 215  
 oils 134  
 oily 41  
 ointment 47, 109  
 okra 122  
 old 321  
 olive oil 134  
 olives 151  
 Oman 318  
 omelette 158  
 on time 305  
 on top of 320  
 oncology 49  
 one 308  
 one billion 309  
 one million 309  
 one thousand 309  
 one-way 194
- one-way system 298  
 onion 124  
 online 177  
 onto 320  
 onyx 289  
 opal 288  
 open 260, 321  
 open sandwich 155  
 open-top 260  
 opera 255  
 operating room 48  
 operation 48  
 operator 99  
 ophthalmology 49  
 opponent 236  
 opposite 320  
 optic 150  
 optic nerve 51  
 optician 51, 189  
 orange 126, 274  
 orange juice 148  
 orangeade 144  
 orbit 280  
 orchestra 254, 256  
 orchestra pit 254  
 orchid 111  
 order v 153  
 oregano 133  
 organic 91, 118, 122  
 organic waste 61  
 origami 275  
 ornamental 87  
 orthopedics 49  
 osteopathy 54  
 ostrich 292  
 otter 290  
 ounce 310  
 out 225, 228, 320  
 out of bounds 226  
 out of focus 271  
 outdoor motor 215  
 outbuilding 182  
 outdoor activities 262  
 outer core 282  
 outfield 229  
 outlet 61  
 outpatient 48  
 outside 320  
 outside lane 194  
 out-tray 172  
 oval 164  
 ovary 20  
 oven 66  
 oven glove 69  
 ovenproof 69  
 over 320  
 over par 233  
 overalls 82  
 overdraft 96  
 overexposed 271  
 overflow pipe 61  
 overhead locker 210  
 overhead projector 163  
 overtake v 195  
 overture 256  
 ovulation 20, 52  
 owl 292  
 oyster 121

ozone layer 286

**P**

Pacific Ocean 312  
 pack 311  
 pack of cards 273  
 packet 311  
 packet of cigarettes 112  
 pad 224  
 paddle 241  
 paddling pool 263  
 paddock 242  
 pads 53, 220  
 pajamas 33  
 painkiller 47, 109  
 paint 83  
 paint v 83  
 paint tin 83  
 paint tray 83  
 painter 191  
 painting 62, 261, 274  
 paints 274  
 Pakistan 318  
 palate 19  
 palette 274  
 pallet 186  
 palm 15, 86, 296  
 palm hearts 122  
 palmtop 175  
 pan 310  
 pan-fried 159  
 Panama 314  
 pancakes 157  
 pancreas 19  
 panda 281  
 panty liner 108  
 papaya 128  
 paper clip 173  
 paper guide 172  
 paper napkin 154  
 paper tray 172  
 papier-maché 275  
 paprika 132  
 Papua New Guinea 319  
 par 233  
 parachute 248  
 parachuting 248  
 paragliding 248  
 Paraguay 315  
 parallel 165  
 parallel bars 235  
 parallelogram 164  
 paramedic 94  
 parcel 99  
 parents 23  
 park 262  
 park v 195  
 parking lot 298  
 parking meter 195  
 parmesan 142  
 parole 181  
 parrot 293  
 parsley 133  
 parsnip 125  
 partner 23  
 pass 226  
 pass v 220, 223  
 passenger 216

passenger port 216  
 passion fruit 128  
 Passover 27  
 passport 213  
 passport control 213  
 pasta 158  
 pastels 274  
 pasteurized 137  
 pasting brush 82  
 pasting table 82  
 pastry 140, 149  
 pastry brush 69  
 pasture 182  
 patch 207  
 patchwork 277  
 pâté 142, 156  
 path 58, 85  
 pathology 49  
 patient 45  
 patio garden 85  
 pattern 276  
 pause 269  
 pavement 298  
 pavement café 148  
 paving 85  
 pawn 272  
 pay v 153  
 pay in v 96  
 pay per view channel 269  
 payment 96  
 payroll 175  
 peach 126, 128  
 peacock 293  
 peanut 129, 151  
 peanut butter 135  
 peanut oil 135  
 pear 127  
 peas 131  
 pecan 129  
 pectoral 16  
 pectoral fin 294  
 pedal 61, 206  
 pedal v 207  
 pedestrian crossing 195  
 pedestrian zone 299  
 pediatrics 49  
 pedicure 41  
 pediment 301  
 peel v 67  
 peeled prawns 120  
 peeler 68  
 pelican 292  
 pelvis 17  
 pen 163, 185  
 penalty 222  
 penalty area 223  
 pencil 163, 275  
 pencil case 163  
 pencil sharpener 163  
 pendant 36  
 penpal 24  
 penguin 292  
 peninsula 282  
 penis 21  
 pentagon 164  
 peony 111  
 people 12, 16  
 people carrier 199

pepper 64, 124, 152  
 peppercorn 132  
 pepperoni 142  
 percentage 165  
 percussion 257  
 perennial 86  
 perfume 41  
 perfumery 105  
 pergola 84  
 periodical 168  
 perm 39  
 perpendicular 165  
 persimmon 128  
 personal best 234  
 personal CD player 269  
 personal organizer 173, 175  
 personal trainer 250  
 personnel department 175  
 Peru 315  
 pesticide 89, 183  
 pestle 68, 167  
 pet food 107  
 pet store 115  
 petal 297  
 petri dish 166  
 pharmacist 108, 189  
 pharynx 19  
 pheasant 119, 293  
 phillips screwdriver 81  
 philosophy 169  
 Philippines 319  
 photo album 271  
 photo finish 234  
 photo frame 271  
 photofit 181  
 photographer 191  
 photograph 271  
 photograph v 271  
 photography 270  
 physical education 162  
 physical therapy 49  
 physics 162, 169  
 piano 256  
 piccolo 257  
 pick v 91  
 pick and mix 113  
 pickax 187  
 pickled 159  
 pickup 258  
 picnic 263  
 picnic bench 266  
 pie 158  
 pie tin 69  
 piece 272  
 pier 217  
 pies 143  
 pig 185  
 pig farm 183  
 pigeon 292  
 pigeonhole 100  
 piglet 185  
 pigsty 185  
 pigtailed 39  
 Pilates 251  
 pill 21, 109  
 pillar 300  
 pillion 204  
 pillow 70

pillowcase 71  
 pilot 190, 211  
 pin 60, 237, 249, 276  
 pin number 96  
 pincushion 276  
 pine 296  
 pine nut 129  
 pineapple 128  
 pineapple juice 149  
 pink 274  
 pint 311  
 pinto beans 131  
 pip 128  
 pipe 112, 202  
 pipe cutter 81  
 pipette 167  
 piping bag 69  
 pistachio 129  
 pita bread 139  
 pitch 256, 266  
 pitch v 229  
 pitch a tent v 266  
 pitcher 65, 151, 229  
 pitcher's mound 228  
 pitches available 266  
 pith 126  
 pizza 154  
 pizza parlor 154  
 place mat 64  
 place setting 65  
 placenta 52  
 plain 285  
 plain flour 139  
 plane 81  
 plane v 79  
 planet 280, 282  
 plant v 183  
 plant pot 89  
 plants 86, 296  
 plaque 50  
 plaster 47, 83  
 plaster v 82  
 plastic bag 122  
 plastic pants 30  
 plastic surgery 49  
 plate 65, 283  
 plateau 284  
 platform 208  
 platform number 208  
 platform shoe 37  
 platinum 289  
 play 254, 269  
 play v 229, 273  
 player 221, 231, 273  
 playground 263  
 playhouse 75  
 playing 75  
 playpen 75  
 plea 180  
 please 322  
 Plimsoll line 214  
 plow v 183  
 plug 60, 72  
 plum 126  
 plumb line 82  
 plumber 188  
 plumbing 61  
 plunger 81

plus 165  
 Pluto 280  
 plywood 79  
 pneumatic drill 187  
 poach v 67  
 poached 159  
 pocket 32  
 pod 122  
 podium 235, 256  
 point 273  
 poisoning 46  
 poker 273  
 Poland 316  
 polar bear 291  
 pole 245, 282  
 pole vault 234  
 police 94  
 police car 94  
 police officer 94  
 police station 94  
 policeman 189  
 polish 77  
 polish v 77  
 politics 169  
 polo 243  
 polyester 277  
 pomegranate 128  
 pommel 242  
 pommel horse 235  
 pond 85  
 ponytail 39  
 pool 249  
 pop 259  
 popcorn 255  
 poplar 296  
 popper 30  
 poppy 297  
 poppy seeds 138  
 porch 58  
 porch light 58  
 pore 15  
 pork 118  
 port 145, 176, 214, 216  
 porter 100  
 portfolio 97  
 porthole 214  
 portion 74  
 portrait 271  
 Portugal 316  
 positive electrode 167  
 post office 98  
 postage 98  
 postal order 98  
 postal worker 98  
 postcard 112  
 poster 255  
 poster paint 274  
 postgraduate 169  
 postmark 98  
 pot plant 110  
 pot up v 91  
 potato 124  
 pot-pourri 111  
 potted plant 87  
 potter's wheel 275  
 pottery 275  
 potty 74  
 pouch 291

- poultry 119  
poultry farm 183  
pound 310  
pour v 67  
powder 77, 109  
powder puff 40  
powdered milk 137  
power 60  
power cable 176  
power cut 60  
practice swing 233  
praying mantis 295  
pregnancy 52  
pregnancy test 52  
pregnant 52  
premature 52  
premolar 50  
prenatal 52  
prerecorded 178  
prescription 45  
present 27  
presentation 174  
presenter 178  
preservative 83  
preserved fruit 134  
press 178  
presser foot 276  
press-up 251  
pressure valve 61  
price 152, 199  
price list 154  
prickly pear 128  
primer 83  
primrose 297  
principal 163  
principality 315  
print 271  
print v 172  
printer 172, 176  
printing 275  
prison 181  
prison guard 181  
private bathroom 100  
private jet 211  
private room 48  
probe 50  
problems 271  
processed grains 130  
procession 27  
processor 176  
producer 254  
program (computer) 176  
program 254, 269  
programming 178  
projector 174  
promenade 265  
propagate v 91  
propeller 211, 214  
proposal 174  
prosciutto 143  
prosecution 180  
prostate 21  
protractor 165  
proud 25  
prove v 139  
province 315  
prow 215  
prune 129  
prune v 91  
pruners 89  
psychiatry 49  
psychotherapy 55  
public address system 209  
puck 224  
Puerto Rico 314  
puff pastry 140  
pull up v 251  
pulp 127  
pulse 47  
pumice 288  
pumice stone 73  
pump 207  
pumpkin 125  
pumpkin seed 131  
punch 237  
punch bag 237  
puncture 203, 207  
pup 290  
pupil 51, 162  
puppy 290  
purple 274  
purse 37  
pushpin 173  
putt v 233  
putter 233  
pyramid 164
- Q**  
Qatar 318  
quadriceps 16  
quail 119  
quail egg 137  
quart 311  
quarter of an hour 304  
quarterdeck 214  
quartz 289  
quay 216  
queen 272, 273  
question 163  
question v 163  
quilt 71  
quilting 277  
quince 128  
quinoa 130  
quiver 249
- R**  
rabbit 118, 290  
raccoon 290  
race 234  
racecourse 243  
racehorse 243  
racing bike 205, 206  
racing dive 239  
racing driver 249  
rack 166  
racquet 230  
racquet games 231  
racquetball 231  
radar 214, 281  
radiator 60, 202  
radicchio 123  
radio 179, 268  
radio antenna 214  
radio station 179  
radiology 49  
radish 124  
radius 17, 164  
rafter 186  
rafting 241  
rail 208  
rail network 209  
rain 287  
rain boots 31  
rainbow 287  
rainbow trout 120  
raincoat 31, 32  
rain forest 285  
raisin 129  
rake 88  
rake v 90  
rally 230  
rally driving 249  
RAM 176  
Ramadan 26  
ramekin 69  
rap 259  
rapeseed 184  
rapeseed oil 135  
rapids 240, 284  
rash 44  
rasher 119  
raspberry 127  
raspberry jam 134  
rat 290  
rattle 74  
raw 124, 129  
ray 294  
razor blade 73  
razor-shell 121  
read v 162  
reading light 210  
reading list 168  
reading room 168  
real estate agent 189  
real estate agency 115  
reamer 80  
rear light 207  
rear wheel 197  
rearview mirror 198  
receipt 152  
receive v 177  
receiver 99  
reception 100  
receptionist 100, 190  
rechargeable drill 78  
record 234, 269  
record player 268  
record shop 115  
recording studio 179  
rectangle 164  
rectum 21  
recycling bin 61  
red 145, 274  
red card 223  
red eye 271  
red kidney beans 131  
red lentils 131  
red meat 118  
red mullet 120  
Red Sea 313  
reduce v 172  
reel 244  
reel in v 245  
refectory 168  
referee 222, 226  
referral 49  
reflector 50, 204, 207  
reflector strap 205  
reflexology 54  
refrigerator 67  
refrigerator-freezer 67  
reggae 259  
region 315  
register 100  
registered mail 98  
regulator 239  
reheat v 154  
reiki 55  
reins 242  
relationships 24  
RAM 176  
relatives 23  
relaxation 55  
relay race 235  
release v 245  
remote control 269  
Renaissance 301  
renew v 168  
rent 58  
rent v 58  
repair kit 207  
report 174  
reporter 179  
reproduction 20  
reproductive 19  
reproductive organs 20  
reptiles 293  
research 169  
reserve v 168  
residence hall 168  
respiratory 19  
rest 256  
restaurant 101, 152  
result 49  
resurfacing 187  
resuscitation 47  
retina 51  
retire v 26  
return 231  
return address 98  
return date 168  
rev counter 201  
reverse v 195  
rewind 269  
rhinoceros 291  
rhombus 164  
rhubarb 127  
rhythmic gymnastics 235  
rib 17, 119  
ribcage 17  
ribbon 27  
ribbon 39, 111, 141, 235  
ribs 155  
rice 130, 158, 184  
rice ball 154  
rice bowl 64  
rice pudding 140  
rice vinegar 135  
rice wine 152  
rider 242  
riding boot 242  
riding crop 242  
riding hat 242  
rigging 215, 240  
right 260  
right field 229  
right-hand drive 201  
rim 206  
rind 119, 127, 136, 142  
ring 36  
ring finger 15  
ring ties 89  
rings 235  
rinse v 38, 76  
ripe 129  
rise v 139  
river 284  
road bike 206  
road markings 194  
road signs 195  
roads 194  
roadworks 187, 195  
roast 158  
roast v 67  
roasted 129  
robe 38, 169  
rock climbing 248  
rock concert 258  
rock garden 84  
rocks 284, 288  
Rocky Mountains 312  
rococo 301  
rodeo 243  
roll 139, 311  
roll v 67  
roller 83, 187  
roller blind 63  
roller coaster 262  
roller skating 249  
rollerblading 263  
rollerskate 249  
rolling pin 69  
romance 255  
Romania 316  
romper suit 30  
roof 58, 203  
roof garden 84  
roof tile 187  
roofrack 198  
rook 272  
room 58  
room key 100  
room number 100  
room service 101  
rooms 100  
root 50, 124, 296  
roots 39  
rope 248  
rose 89, 110, 145  
rosé 145  
rosemary 133  
rotor blade 211  
rotten 127  
rough 232  
round 237  
round neck 33  
route number 196  
router 78  
row 210, 254  
row v 241



- rower 241  
 rowing boat 214  
 rowing machine 250  
 rubber 163  
 rubber band 173  
 rubber boots 89  
 rubber ring 265  
 rubber stamp 173  
 ruby 288  
 ruck 221  
 rudder 210, 241  
 rug 63  
 rugby 221  
 rugby field 221  
 rugby uniform 221  
 ruler 163, 165  
 rum 145  
 rum and coke 151  
 rump steak 119  
 run 228  
 run v 228  
 runner bean 122  
 runway 212  
 rush 86  
 Russian Federation 318  
 Rwanda 317  
 rye bread 138
- S**  
 sad 25  
 saddle 206, 242  
 safari park 262  
 safe 228  
 safety 75, 240  
 safety barrier 246  
 safety goggles 81, 167  
 safety pin 47  
 saffron 132  
 sage 133  
 Sahara Desert 313  
 sail 241  
 sailboat 215  
 sailing 240  
 sailor 189  
 salad 149  
 salamander 294  
 salami 142  
 salary 175  
 sales assistant 104  
 sales department 175  
 salmon 120  
 saloon 199  
 salt 64, 152  
 salted 121, 129, 137, 143  
 San Marino 316  
 sand 85, 264  
 sand v 82  
 sandal 37  
 sandals 31  
 sandcastle 265  
 sander 78  
 sandpaper 81, 83  
 sandpit 263  
 sandstone 288  
 sandwich 155  
 sandwich counter 143  
 sanitary towel 108  
 São Tomé and Príncipe 317
- sapphire 288  
 sardine 120  
 Sardinia 316  
 sashimi 121  
 satellite 281  
 satellite dish 269  
 satellite navigation 201  
 satsuma 126  
 Saturday 306  
 Saturn 280  
 sauce 134, 143, 155  
 saucepan 69  
 Saudi Arabia 318  
 sauna 250  
 sausage 155, 157  
 sausages 118  
 sauté v 67  
 save v 177, 223  
 savings 96  
 savings account 97  
 savoury 155  
 saw v 79  
 saxophone 257  
 scaffolding 186  
 scale 121, 256, 294  
 scales 45, 53, 69, 98, 118, 166, 212, 293, 310  
 scallop 121  
 scalp 39  
 scalpel 81, 167  
 scan 48, 52  
 scanner 106, 176  
 scarecrow 184  
 scared 25  
 scarf 31, 36  
 schist 288  
 scholarship 169  
 school 162, 299  
 school bag 162  
 school bus 196  
 school uniform 162  
 schoolboy 162  
 schoolgirl 162  
 schools 169  
 science 162, 166  
 science fiction film 255  
 scientist 190  
 scissors 38, 47, 82, 188, 276  
 scoop 68, 149  
 scooter 205  
 score 220, 256, 273  
 score a goal v 223  
 scoreboard 225  
 scorpion 295  
 scotch and water 151  
 scrabble 272  
 scrambled eggs 157  
 scrape v 77  
 scraper 82  
 screen 59, 63, 97, 176, 255, 269  
 screen wash 199  
 screen wash reservoir 202  
 screw 80  
 screwdriver 80  
 screwdriver bits 80  
 script 254  
 scrollbar 177
- scrotum 21  
 scrub v 77  
 scrum 221  
 scuba diving 239  
 sculpting 275  
 sculptor 191  
 sea 264, 282  
 sea bass 120  
 sea bream 120  
 sea horse 294  
 sea lion 290  
 sea plane 211  
 seafood 121  
 seal 290  
 sealant 83  
 sealed jar 135  
 seam 34  
 seamstress 191  
 search v 177  
 seasonal 129  
 seasons 306  
 seat 61, 204, 209, 210, 242, 254  
 seat back 210  
 seat belt 198, 211  
 seat post 206  
 seating 254  
 second 304, 309  
 second floor 104  
 second hand 304  
 second-hand shop 115  
 section 282  
 security 212  
 security bit 80  
 security guard 189  
 sedative 109  
 sedimentary 288  
 seed 122, 127, 130  
 seed tray 89  
 seeded bread 139  
 seedless 127  
 seedling 91  
 seeds 88, 131  
 seesaw 263  
 segment 126  
 self defence 237  
 self-raising flour 139  
 self-tanning cream 41  
 semidetached 58  
 semi-hard cheese 136  
 seminal vesicle 21  
 semi-skimmed milk 136  
 semi-soft cheese 136  
 semolina 130  
 send v 177  
 send off 223  
 Senegal 317  
 sensitive 41  
 sentence 181  
 September 306  
 serve 231  
 serve v 64, 231  
 server 176  
 service included 152  
 service line 230  
 service not included 152  
 service provider 177  
 service vehicle 212
- sesame seed 68  
 sesame seed oil 134  
 set 178, 230, 254  
 set v 38  
 set honey 134  
 set sail v 217  
 set square 165  
 set the alarm v 71  
 seven 308  
 seven hundred 308  
 seventeen 308  
 seventeenth 309  
 seventh 309  
 seventieth 309  
 seventy 308  
 sew v 277  
 sewing basket 276  
 sewing machine 276  
 sexually transmitted disease 20  
 shade 41  
 shade plant 87  
 shallot 125  
 shallow end 239  
 shampoo 38  
 shapes 164  
 share price 97  
 shares 97  
 shark 294  
 sharp 256  
 sharpening stone 81  
 shaving 73  
 shaving foam 73  
 shears 89  
 shed 84  
 sheep 185  
 sheep farm 183  
 sheep's milk 137  
 sheet 71, 74, 241  
 shelf 67, 106  
 shell 129, 137, 265, 293  
 shelled 129  
 shelves 66  
 sherry 145  
 shiatsu 54  
 shield 88  
 shin 12  
 ship 214  
 ships 215  
 shipyard 217  
 shirt 32  
 shitake mushrooms 124  
 shock 47  
 shocked 25  
 shoe department 104  
 shoe store 114  
 shoes 34, 37  
 shoot v 223, 227  
 shopping 104  
 shopping bag 106  
 shopping center 104  
 short 32, 321  
 short wave 179  
 short-grain 130  
 shorts 30, 33  
 shot 151  
 shotput 234
- shoulder 13  
 shoulder bag 37  
 shoulder blade 17  
 shoulder pad 35  
 shoulder strap 37  
 shout v 25  
 shovel 187  
 shower 72  
 shower block 266  
 shower curtain 72  
 shower door 72  
 shower gel 73  
 shower head 72  
 showjumping 243  
 shuffle v 273  
 shutoff valve 61  
 shutter 58  
 shutter release 270  
 shutter-speed dial 270  
 shuttle bus 197  
 shuttlecock 231  
 shy 25  
 Siberia 313  
 Sicily 316  
 side 164  
 sideline 220  
 side order 153  
 side plate 65  
 side saddle 242  
 side street 299  
 sidedeck 240  
 side-effects 109  
 sideline 226, 230  
 Sierra Leone 317  
 sieve 68, 89  
 sieve v 91  
 sift v 138  
 sigh v 25  
 sightseeing 260  
 sign 104  
 signal 209  
 signature 96, 98  
 silencer 203, 204  
 silk 277  
 silo 183  
 silt 85  
 silver 235, 289  
 simmer v 67  
 Singapore 319  
 singer 191  
 single 151  
 single bed 71  
 single cream 137  
 single room 100  
 singles 230  
 sink 38, 61, 66  
 sinus 19  
 siren 94  
 sirloin steak 119  
 sister 22  
 sister-in-law 23  
 site manager's office 266  
 sit-up 251  
 six 308  
 six hundred 308  
 sixteen 308  
 sixteenth 309

- sixth 309  
 sixtieth 309  
 sixty 308  
 skate 120, 247, 294  
 skate v 224  
 skate wings 120  
 skateboard 249  
 skateboarding 249, 263  
 skein 277  
 skeleton 17  
 sketch 275  
 sketch pad 275  
 skewer 68  
 ski 241, 246  
 ski boot 246  
 ski jump 247  
 ski pole 246  
 ski run 246  
 ski slope 246  
 ski suit 246  
 skier 246  
 skiing 246  
 skin 14, 119, 128  
 skin care 108  
 skinned 121  
 skipping 251  
 skirt 30, 34  
 skull 17  
 skydiving 248  
 skyscraper 299, 300  
 slalom 247  
 slate 288  
 sledding 247  
 sledgehammer 187  
 sleeper 30  
 sleeping 74  
 sleeping bag 267  
 sleeping compartment 209  
 sleeping mat 267  
 sleeping pill 109  
 sleet 286  
 sleeve 34  
 sleeveless 34  
 slice 119, 139, 140, 230  
 slice v 67  
 sliced bread 138  
 slicer 139  
 slide 167, 263  
 slide v 229  
 sling 46  
 slip 35  
 slip road 194  
 slip-on 37  
 slippers 31  
 slope 284  
 slotted spoon 68  
 Slovakia 316  
 Slovenia 316  
 slow 321  
 slug 295  
 small 321  
 small car 199  
 small intestine 18  
 small of back 13  
 smash 231  
 smile 25  
 smoke 95  
 smoke alarm 95  
 smoked 118, 121, 143, 159  
 smoked fish 143  
 smoking 112  
 smoking section 152  
 snack bar 113, 148  
 snail 295  
 snake 293  
 snare drum 257  
 sneeze 44  
 snooker 249  
 snore v 71  
 snorkel 239  
 snout 293  
 snow 287  
 snowboarding 247  
 snowmobile 247  
 snowsuit 30  
 soak v 130  
 soap 73, 178  
 soap dish 73  
 soccer 222  
 soccer player 222  
 soccer uniform 31, 222  
 socket 60, 80  
 socket wrench 80  
 socks 33  
 soda bread 139  
 soda water 144  
 sofa 62  
 sofabed 63  
 soft 129, 321  
 soft cheese 136  
 soft drink 154  
 soft drinks 144  
 soft toy 75  
 software 176  
 softwood 79  
 soil 85  
 solar system 280  
 solder 79, 80  
 solder v 79  
 soldering iron 81  
 soldier 189  
 sole 15, 37  
 solids 164  
 Solomon Islands 319  
 soluble 109  
 solvent 83  
 Somalia 317  
 somersault 235  
 son 22  
 sonata 256  
 song 259  
 son-in-law 22  
 sorbet 141  
 sorrel 123  
 sorting unit 61  
 soufflé 158  
 soufflé dish 69  
 sound boom 179  
 sound technician 179  
 soundtrack 255  
 soup 153, 158  
 soup bowl 65  
 soup spoon 65  
 sour 127  
 sour cream 137  
 sourdough bread 139  
 south 312  
 South Africa 317  
 South Korea 318  
 Southern Hemisphere 283  
 Southern Ocean 313  
 souvenirs 260  
 sow v 90, 183  
 soybeans 131  
 soy sauce 135  
 space 280  
 space exploration 281  
 space shuttle 281  
 space station 281  
 space suit 281  
 spade 88, 265, 273  
 Spain 316  
 spanner 80  
 spare tire 203  
 spark plug 203  
 sparkling 144  
 sparring 237  
 sparrow 292  
 spatula 68, 167  
 speaker 174, 176, 258, 268  
 speaker stand 268  
 spearfishing 245  
 specials 152  
 spectators 233  
 speed boating 241  
 speed limit 195  
 speed skating 247  
 speedboat 214  
 speedometer 201, 204  
 spell v 162  
 sperm 20  
 sphere 164  
 spices 132  
 spicy sausage 142  
 spider 295  
 spike v 90  
 spikes 233  
 spin 230  
 spin v 76  
 spin dryer 76  
 spinach 123  
 spine 17  
 spire 300  
 spirit level 80, 187  
 splashback 66  
 spleen 18  
 splint 47  
 splinter 46  
 split ends 39  
 split peas 131  
 spoke 207  
 sponge 73, 74, 83  
 sponge cake 140  
 sponge fingers 141  
 spool 245  
 spoon 65  
 sport fishing 245  
 sports 105, 220, 236, 248  
 sports car 198  
 sports field 168  
 sports jacket 33  
 sportsman 191  
 spotlight 259  
 sprain 46  
 spray 109  
 spray v 91  
 spray can 311  
 spray gun 89  
 spring 71, 307  
 spring balance 166  
 spring greens 123  
 springboard 235, 238  
 sprinkler 89  
 sprinter 234  
 sprocket 207  
 square 164, 272, 299  
 square foot 310  
 square meter 310  
 squash 231  
 squat 251  
 squid 121, 295  
 squirrel 290  
 Sri Lanka 318  
 St. Kitts and Nevis 314  
 St. Lucia 314  
 St. Vincent and the  
 Grenadines 314  
 stabilisers 207  
 stable 185, 243  
 stadium 223  
 staff 175, 256  
 stage 167, 254  
 stages 23  
 stainless steel 79  
 stair gate 75  
 staircase 59  
 stake 90  
 stake v 91  
 stalk 122, 297  
 stalls 254  
 stamen 297  
 stamp 98  
 stamp collecting 273  
 stamps 112  
 stance 232  
 stand 88, 205, 268  
 stapler 173  
 staples 173  
 star 280  
 star anise 133  
 starfish 295  
 starfruit 128  
 start school v 26  
 starter 153  
 starting block 234, 238  
 starting line 234  
 state 315  
 statement 180  
 stationery 105  
 station wagon 199  
 statuette 260  
 steak 121  
 steam v 67  
 steam train 208  
 steamed 159  
 steplechase 243  
 steering wheel 201  
 steel wool 81  
 stem 111, 112, 297  
 stencil 83  
 stenographer 181  
 step machine 250  
 stepdaughter 23  
 stepfather 23  
 stepladder 82  
 stepmother 23  
 stepson 23  
 stereo 269  
 sterile 47  
 stern 240  
 stethoscope 45  
 stew 158  
 stick 224, 249  
 sticks 133  
 sticky tape 173  
 still 144  
 sting 46, 295  
 stir v 67  
 stirrer 150  
 stirrup 242  
 stitch 277  
 stitch selector 276  
 stitches 52  
 stock broker 97  
 stock exchange 97  
 stockings 35  
 stocks 97, 110  
 stomach 18  
 stomach ache 44  
 stone 36, 275  
 stoned fruit 126  
 stop 269  
 stop button 197  
 stopper 166  
 stopwatch 234  
 store 114, 298  
 store assistant 188  
 store directory 104  
 stork 292  
 storm 287  
 stout 145  
 stovetop 67  
 straight 39, 165  
 straight on 260  
 straighten v 39  
 strap 35  
 strapless 34  
 stratosphere 286  
 straw 144, 154  
 strawberry 127  
 strawberry milkshake 149  
 stream 285  
 street 298  
 street corner 298  
 street light 298  
 street sign 298  
 street stall 154  
 stress 55  
 stretch 251  
 stretcher 94  
 strike 228, 237  
 string 230, 258  
 string of pearls 36  
 strings 256  
 strip v 82  
 stroke 44, 233, 239  
 strokes 231  
 stroller 75  
 strong 321  
 strong flour 139

- stub 96  
 study 63, 162  
 stuffed 159  
 stuffed olive 143  
 stump 225  
 styles 39, 239, 301  
 submarine 215  
 subsoil 91  
 substitute 223  
 substitution 223  
 subtract v 165  
 suburb 299  
 succulent 87  
 suction hose 77  
 Sudan 317  
 sugarcane 184  
 suit 273  
 sulfur 289  
 sultana 129  
 summer 31, 307  
 summons 180  
 sumo wrestling 237  
 Sun 280  
 sunbathe v 264  
 sunbed 41  
 sunblock 108, 265  
 sunburn 46  
 Sunday 306  
 sunflower 184, 297  
 sunflower oil 134  
 sunflower seed 131  
 sunglasses 51, 265  
 sunhat 30, 265  
 sunny 286  
 sunrise 305  
 sunroof 202  
 sunscreen 108  
 sunset 305  
 sunshine 286  
 suntan lotion 265  
 supermarket 106  
 supersonic jet 211  
 supplement 55  
 supply pipe 61  
 support 187  
 suppository 109  
 surf 241  
 surfboard 241  
 surfcasting 245  
 surfer 241  
 surfing 241  
 surgen 48  
 surgery 45, 48  
 Suriname 315  
 surprised 25  
 sushi 121  
 suspect 94, 181  
 suspenders 35  
 suspension 203, 205  
 swallow 292  
 swamp 285  
 swan 293  
 Swaziland 317  
 sweater 33  
 sweatpants 33  
 sweatshirt 33  
 rutabaga 125  
 Sweden 316
- sweep v 77  
 sweet 124, 127, 155  
 sweet potato 125  
 sweet shop 113  
 sweet spreads 134  
 sweet cart 152  
 swim v 238  
 swimmer 238  
 swimming 238  
 swimming pool 101, 238,  
 250  
 swimsuit 238, 265  
 swing v 232  
 swings 263  
 swiss chard 123  
 switch 60  
 Switzerland 316  
 swivel chair 172  
 sword 236  
 swordfish 120, 294  
 symphony 256  
 synagogue 300  
 synchronized swimming 239  
 synthetic fiber 31  
 Syria 318  
 syringe 109, 167  
 syrup 109  
 system 176
- T**  
 tab 173  
 table 64, 148  
 table tennis 231  
 tablecloth 64  
 tack v 241, 277  
 tackle 245  
 tackle v 220, 223  
 tackle box 244  
 tadpole 294  
 tae-kwon-do 236  
 tag v 229  
 tai chi 236  
 tail 121, 210, 242, 280, 290,  
 294  
 tail light 204  
 tailbone 17  
 tailgate 198  
 tailor 191  
 tailored 35  
 tailor's 115  
 tailor's chalk 276  
 tailor's dummy 276  
 tailplane 210  
 Tajikistan 318  
 take a bath v 72  
 take a shower v 72  
 take notes v 163  
 take off v 211  
 take-out 154  
 talcum powder 73  
 tall 321  
 tamarillo 128  
 tambourine 257  
 tampon 108  
 tan 41  
 tandem 206  
 tangerine 126  
 tank 61
- Tanzania 317  
 tap water 144  
 tape dispenser 173  
 tape measure 80, 276  
 target 249  
 target shooting 249  
 tarmac 187  
 taro root 124  
 tarragon 133  
 Tasmania 319  
 tattoo 41  
 tax 96  
 taxi driver 190  
 taxi rank 213  
 tea 144, 149, 184  
 tea with lemon 149  
 tea with milk 149  
 teabag 144  
 teacher 54, 162, 191  
 teacup 65  
 team 220, 229  
 teapot 65  
 tear 51  
 teaspoon 65  
 teat 75  
 techniques 79, 159  
 teddy bear 75  
 tee 233  
 teeing ground 232  
 teenager 23  
 tee-off v 233  
 telegram 98  
 telephone 99, 172  
 telephone box 99  
 telescope 281  
 television series 178  
 television studio 178  
 temperature 286  
 temperature gauge 201  
 temple 14, 300  
 ten 308  
 ten thousand 309  
 tenant 58  
 tend v 91  
 tendon 17  
 tennis 230  
 tennis court 230  
 tennis shoes 231  
 tenon saw 81  
 tent 267  
 tent peg 266  
 tent pole 266  
 tenth 309  
 tequila 145  
 terminal 212  
 termite 295  
 terrace café 148  
 terraced 58  
 territory 315  
 terry diaper 30  
 test 49  
 testis 21  
 test tube 166  
 text message 99  
 textbook 163  
 Thailand 318  
 thank you 322  
 Thanksgiving 27
- the day after tomorrow 307  
 the day before yesterday 307  
 theater 254, 299  
 theme park 262  
 therapist 55  
 thermals 267  
 thermometer 45, 167  
 thermosphere 286  
 thermostat 61  
 thesis 169  
 thick 321  
 thigh 12, 119  
 thimble 276  
 thin 321  
 third 309  
 thirteen 308  
 thirteenth 309  
 thirtieth 309  
 thirty 308  
 this way up 98  
 this week 307  
 thistle 297  
 thoracic vertebrae 17  
 thread 276  
 thread v 277  
 thread guide 276  
 thread reel 276  
 three 308  
 three hundred 308  
 three-door 200  
 three-point line 226  
 thriller 255  
 throat 19  
 throat lozenge 109  
 throttle 204  
 through 320  
 throw 237  
 throw v 221, 227, 229  
 throw-in 223, 226  
 thruster 281  
 thumb 15  
 thunder 286  
 Thursday 306  
 thyme 133  
 thyroid gland 18  
 tibia 17  
 ticket 209, 213  
 ticket barrier 209  
 ticket inspector 209  
 ticket office 209, 216  
 tie 32  
 tiebreak 230  
 tie-pin 36  
 tiger 291  
 tights 35, 251  
 tile 58, 272  
 tile v 82  
 till 106, 150  
 tiller 240  
 timber 187  
 time 234, 304  
 time out 220  
 timer 166  
 times 165, 261  
 timetable 197, 209, 261  
 timing 203  
 tip 36, 122, 246  
 tire 198, 205, 206
- tire lever 207  
 tire pressure 203  
 tissue 108  
 title 168  
 titles 23  
 to 320  
 toad 294  
 toast 157  
 toasted sandwich 149  
 toaster 66  
 tobacco 112, 184  
 today 306  
 toddler 30  
 toe 15  
 toe clip 207  
 toe strap 207  
 toenail 15  
 toffee 113  
 toggle 31  
 Togo 317  
 toilet 72  
 toilet brush 72  
 toilet roll 72  
 toilet seat 72  
 toiletries 41, 107  
 toilets 104, 266  
 toll booth 194  
 tomato 125, 157  
 tomato juice 144, 149  
 tomato sauce 154  
 tomorrow 306  
 toner 41  
 tongs 150, 167  
 tongue 19, 37, 118  
 tonic water 144  
 tonne 310  
 tool rack 78  
 toolbar 177  
 toolbelt 186  
 toolbox 80  
 tools 187  
 tooth 50  
 toothache 50  
 toothbrush 72  
 toothpaste 72  
 top coat 83  
 top dress v 90  
 top tier 141  
 topaz 288  
 topiary 87  
 topping 155  
 topsoil 85  
 tornado 287  
 tortoise 293  
 touch line 221  
 touchdown 221  
 tour bus 260  
 tour guide 260  
 tourer 205  
 touring bike 206  
 tourist 260  
 tourist attraction 260  
 tourist bus 197  
 tourist information 261  
 tourmaline 288  
 tournament 233  
 tow away v 195  
 tow truck 203



- toward 320  
towel rail 72  
towels 73  
tower 300  
town 298  
town hall 299  
townhouse 58  
toy 75  
toy basket 75  
toys 105  
track 208, 234  
track & field 234  
tracksuit 31, 32  
tractor 182  
traffic 194  
traffic circle 195  
traffic jam 195  
traffic light 194  
traffic policeman 195  
trailer 266  
train 35, 208  
train v 91, 251  
train station 208  
trainer 37  
trainers 31, 251  
tram 196, 208  
transfer 223  
transformer 60  
transmission 202  
transplant v 91  
transport 194  
trapezium 164  
trapezius 16  
trash 177  
trash bin 61, 67  
travel agent 190  
travel agent's 114  
travel sickness pills 109  
traveler's check 97  
tray 152, 154  
tray-table 210  
tread 207  
tread water v 239  
treadmill 250  
treble clef 256  
tree 86, 296  
trekking 243  
trellis 84  
tremor 283  
triangle 164, 257  
triceps 16  
trifle 141  
trim v 39, 90  
trimester 52  
trimmer 88  
Trinidad and Tobago 314  
tripod 166, 270, 281  
trolley bus 196  
trombone 257  
Tropic of Cancer 283  
Tropic of Capricorn 283  
tropical fruit 128  
tropics 283  
troposphere 286  
trot 243  
trough 183  
trousers 32, 34  
trout 120
- trowel 89, 187  
truffle 113, 125  
trug 88  
trumpet 257  
truncheon 94  
trunk 291, 296  
trunks 238  
try 221  
t-shirt 30, 33  
tub 311  
tuba 257  
tube 311  
Tuesday 306  
tug boat 215  
tulip 111  
tumble 235  
tumble dryer 76  
tumbler 65  
tuna 120  
tune v 179  
tune the radio v 269  
tuning peg 258  
Tunisia 317  
turbocharger 203  
turf v 90  
Turkey 318  
turkey 119, 185, 293  
Turkmenistan 318  
turmeric 132  
turn 238  
turn v 79  
turn the television off v 269  
turn the television on v 269  
turnip 124  
turpentine 83  
turquoise 289  
turret 300  
turtle 293  
tusk 291  
tutu 191  
tweezers 40, 47, 167  
twelfth 309  
twelve 308  
twentieth 309  
twenty 308  
twenty minutes 304  
twenty thousand 309  
twenty-first 309  
twenty-one 308  
twenty-second 309  
twenty-third 309  
twenty-two 308  
twig 296  
twin room 100  
twine 89  
twins 23  
twist ties 89  
two 308  
two hundred 308  
two o'clock 304  
two thousand 307  
two thousand and one 307  
two-door 200  
types 199, 205  
types of buses 196  
types of camera 270  
types of farm 183  
types of plants 86
- types of fishing 245  
types of trains 208  
typhoon 286
- U**  
Uganda 317  
ugli 126  
Ukraine 316  
ulna 17  
ultrasound 52  
ultraviolet rays 286  
umbilical cord 52  
umbrella 36, 233  
umpire 225, 229, 230  
tulip 111  
unconscious 47  
uncooked meat 142  
under 320  
under par 233  
undercoat 83  
underexposed 271  
undergraduate 169  
underground map 209  
underground train 209  
underpass 194  
underwear 32, 35  
underwired 35  
uniform 94, 189  
United Arab Emirates 318  
United Kingdom 316  
United States of America 314  
universe 280  
university 299  
unleaded 199  
unpasteurized 137  
unpick v 277  
unsalted 137  
until 320  
up 320  
upper circle 254  
upset 25  
Uranus 280  
ureter 21  
urethra 20  
urinary 19  
urology 49  
Uruguay 315  
usher 255  
utensils 64  
uterus 20, 52  
utility room 76  
Uzbekistan 318
- V**  
vacuum cleaner 77, 188  
vacuum flask 267  
vagina 20  
valance 71  
valley 284  
valve 207  
vanilla 132  
Vanuatu 319  
varnish 79, 83  
vas deferens 21  
vase 63, 111  
Vatican City 316  
vault 235, 300  
veal 118
- vegetable garden 85  
vegetable oil 135  
vegetable plot 182  
vegetables 107, 122, 124  
veggie burger 155  
veil 35  
vein 19  
venetian blind 63  
Venezuela 315  
venison 118  
vent 283  
ventouse cup 53  
Venus 280  
verdict 181  
vest 33, 35, 251  
vet 189  
vibraphone 257  
vice 78  
video game 269  
video phone 99  
video recorder 269  
video tape 269  
Viet Nam 318  
viewfinder 271  
village 299  
vine 183  
vinegar 135, 142  
vineyard 183  
vintage 199  
viola 256  
violin 256  
virus 44  
visa 213  
vision 51  
visiting hours 48  
visor 205  
vitamins 108  
v-neck 33  
vocal cords 19  
vodka 145  
vodka and orange 151  
voice message 99  
volcano 283  
volley 231  
volleyball 227  
voltage 60  
volume 165, 179, 269, 311  
vomit v 44
- W**  
waders 244  
waffles 157  
waist 12  
waistband 35  
waistcoat 33  
waiter 148, 152  
waiting room 45  
waitress 191  
wake up v 71  
walk 243  
walking boot 37, 267  
walkway 212  
wall 58, 186, 222  
wall light 62  
wallet 37  
wallpaper 82, 177  
wallpaper v 82  
wallpaper brush 82
- wallpaper paste 82  
walnut 129  
walnut oil 134  
walrus 290  
ward 48  
wardrobe 70  
warehouse 216  
warm 286  
warm up v 251  
warrant 180  
wash v 38, 77  
washbasin 72  
washer 80  
washer-dryer 76  
washing machine 76  
wasp 295  
waste disposal 61, 266  
waste disposal unit 61  
waste pipe 61  
wastebasket 172  
watch 36  
watch television v 269  
water 144, 238  
water v 90, 183  
water bottle 206, 267  
water chamber 61  
water chestnut 124  
water closet 61  
water garden 84  
water hazard 232  
water jet 95  
water plant 86  
water polo 239  
watercolor paints 274  
watercress 123  
waterfall 285  
watering 89  
watering can 89  
watermelon 127  
waterproofs 245, 267  
waterskier 241  
waterskiing 241  
watersports 241  
wave 241, 264  
wavelength 179  
wax 41  
weak 321  
weather 286  
weaving 277  
website 177  
wedding 26, 35  
wedding cake 141  
wedding dress 35  
wedding reception 26  
wedge 233  
Wednesday 306  
weed v 91  
weed killer 91  
weeds 86  
week 306  
weekend 306  
weekly 307  
weigh v 310  
weight 166, 244  
weight bar 251  
weight belt 239  
weight training 251  
west 312

western 255  
 Western Sahara 317  
 wet 286, 321  
 wet wipe 75, 108  
 wetsuit 239  
 whale 290  
 wheat 130, 184  
 wheel 198, 207  
 wheel nuts 203  
 wheelbarrow 88  
 wheelchair 48  
 wheelchair access 197  
 whiplash 46  
 whipped cream 137  
 whisk 68  
 whisk v 67  
 whiskers 290  
 whisky 145  
 white 39, 145, 272, 274  
 white bread 139  
 white chocolate 113  
 white coffee 148  
 whitecurrant 127  
 white flour 138  
 white meat 118  
 white rice 130  
 white spirit 83  
 whiting 120  
 whole 129, 132  
 whole milk 136  
 wholegrain 131  
 wholegrain flour 138  
 wholegrain mustard 135  
 wholemeal bread 139  
 wicket 225  
 wicket-keeper 225  
 wide 321  
 widescreen television 269  
 width 165  
 wife 22  
 wig 39  
 wild rice 130  
 willow 296  
 win v 273  
 wind 241, 286  
 windbreak 265  
 windcheater 33  
 windlass 214  
 window 58, 96, 98, 177, 186,  
 197, 209, 210  
 windpipe 18  
 windscreen 198  
 windscreen wiper 198  
 windshield 205  
 windsurfer 241  
 windsurfing 241  
 windy 286  
 wine 145, 151  
 wine glass 65  
 wine list 152  
 wine vinegar 135  
 wing 119, 210, 293  
 wing mirror 198  
 wings 254  
 winner 273  
 winter 31, 307  
 winter sports 247  
 wipe v 77

wire 79  
 wire cutter 80  
 wire strippers 81  
 wires 60  
 with 320  
 withdrawal slip 96  
 without 320  
 witness 180  
 wok 69  
 wolf 290  
 woman 23  
 womb 52  
 women's clothing 34  
 women's wear 105  
 wood 79, 233, 275, 285  
 wood glue 78  
 wood shavings 78  
 wooden spoon 68  
 woodpecker 292  
 woodstain 79  
 woodwind 257  
 woodworking 275  
 wool 277  
 work 172  
 work day 306  
 workbench 78  
 workshop 78  
 worktop 66  
 world map 312  
 worm 295  
 worried 25  
 wound 46  
 wrap 155  
 wrapping 111  
 wreath 111  
 wrench 81, 203  
 wrestling 236  
 wrinkle 15  
 wrist 13, 15  
 wristband 230  
 writ 180  
 write v 162

## X

x-ray 48  
 x-ray film 50  
 x-ray machine 212  
 x-ray viewer 45

## Y

yacht 215, 240  
 yam 125  
 yard 310  
 yawn v 25  
 year 163, 306  
 yeast 138  
 yellow 274  
 yellow card 223  
 Yemen 318  
 yes 322  
 yesterday 306  
 yoga 54  
 yogurt 137  
 yolk 137, 157  
 you're welcome 322  
 Yugoslavia 316

## Z

Zambia 317  
 zebra 291  
 zero 308  
 zest 126  
 Zimbabwe 317  
 zinc 289  
 ZIP code 98  
 zipper 277  
 zone 315  
 zones 283  
 zoo 262  
 zoology 169  
 zoom lens 270  
 zucchini 125





## 謝辭 shaji • acknowledgments

DORLING KINDERSLEY would like to thank Tracey Miles and Christine Lacey for design assistance, Georgina Garner for editorial and administrative help, Sonia Gavira, Polly Boyd, and Cathy Meeus for editorial help, and Claire Bowers for compiling the DK picture credits.

The publisher would like to thank the following for their kind permission to reproduce their photographs:

Abbreviations key:

t=top, b=bottom, r=right, l=left, c=center

**Abode:** 62; **Action Plus:** 224bc; **alamy.com:** 154t; A.T. Willett 287bcl; Michael Foyle 184bl; Stock Connection 287bcr; **Allsport/Getty Images:** 238cl; **Alvey and Towers:** 209 acr, 215bcl, 215bcr, 241cr; **Peter Anderson:** 188cbr, 271br. **Anthony Blake Photo Library:** Charlie Stebbings 114cl; John Sims 114tcl; **Andyalte:** 98tl; **apple mac computers:** 268tcr; **Arcaid:** John Edward Linden 301bl; Martine Hamilton Knight, Architects: Chapman Taylor Partners, 213cl; Richard Bryant 301br; **Argos:** 41tcl, 66cbl, 66cl, 66br, 66bcl, 69cl, 70bcl, 71t, 77tl, 269tc, 270tl; **Axiom:** Eitan Simanor 105bcr; Ian Cumming 104; Vicki Couchman 148cr; **Beken Of Cowes Ltd:** 215cbc; **Bosch:** 76tcr, 76tc, 76tcl; **Camera Press:** 27c, 38r, 256t, 257cr; Barry J. Holmes 148tr; Jane Hanger 159cr; Mary Germanou 259bc; **Corbis:** 78b; Anna Clopet 247tr; Bettmann 181tl, 181tr; Bo Zauders 156t; Bob Rowan 152bl; Bob Winsett 247cbl; Brian Bailey 247br; Carl and Ann Purcell 162l; Chris Rainer 247ctcl; ChromoSohm Inc. 179tr; Craig Aurness 215bl; David H.Wells 249cbr; Dennis Marsico 274bl; Dimitri Lundt 236bc; Duomo 211tl; Gail Mooney 277ctcr; George Lepp 248c; Gunter Marx 248cr; Jack Fields 210b; Jack Hollingsworth 231bl; Jacqui Hurst 277cbr; James L. Amos 247bl, 191ctr, 220bcr; Jan Butchofsky 277cbc; Johnathan Blair 243cr; Jon Feingersh 153tr; Jose F. Poblete 191br; Jose Luis Pelaez.Inc 153tc, 175tl; Karl Weatherly 220bl, 247tcr; Kelly Mooney Photography 259tl; Kevin Fleming 249bc; Kevin R. Morris 105tr, 243tl, 243tc; Kim Sayer 249tcr; Lynn Goldsmith 258t; Macduff Everton 231bcl; Mark Gibson 249bl; Mark L. Stephenson 249tcl; Michael Pole 115tr; Michael S. Yamashita 247ctcl; Mike King 247cbl; Neil Rabinowitz 214br; Owen Franken 112t; Pablo Corral 115bc; Paul A. Sounders 169br, 249ctcl;

Paul J. Sutton 224c, 224br; Peter Turnley 105tcr; Phil Schermeister 27b, 248tr; R. W. Jones 309; R.W. Jones 175tr; Richard Hutchings 168b; Rick Doyle 241ctr; Robert Holmes 97br, 277ctc; Roger Ressimeyer 169tr; Russ Schleipman 229; Steve Raymer 168cr; The Purcell Team 211ctr; Tim Wright 178; Vince Streano 194t; Wally McNamee 220br, 220bcl, 224bl; Yann Arhous-Bertrand 249tl; **Demetrio Carrasco / Dorling Kindersley (c) Herge / Les Editions Casterman:** 112ccl; **Dixons:** 270cl, 270cr, 270bl, 270bcl, 270bcr, 270ccr; **Education Photos:** John Walmsley 26tl; **Empics Ltd:** Adam Day 236br; Andy Heading 243c; Steve White 249cbc; **Getty Images:** 48bcl, 100t, 114bcr, 154bl, 287tr; 94tr; **Dennis Gilbert:** 106tc; **Hulsta:** 70t; **Ideal Standard Ltd:** 72r; **The Image Bank/Getty Images:** 58; **Impact Photos:** Eliza Armstrong 115cr; John Arthur 190tl; Philip Achache 246t; **The Interior Archive:** Henry Wilson, Alfie's Market 114bl; Luke White, Architect: David Mikhail, 59tl; Simon Upton, Architect: Phillippe Starck, St Martins Lane Hotel 100bcr, 100br; **Jason Hawkes Aerial Photography:** 216t; **Dan Johnson:** 26cbl, 35r; **Kos Pictures Source:** 215cbl, 240tc, 240tr; David Williams 216b; **Lebrecht Collection:** Kate Mount 169bc; **MP Visual.com:** Mark Swallow 202t; **NASA:** 280cr, 280ccl, 281tl; **P&O Princess Cruises:** 214bl; **P A Photos:** 181br; **The Photographers' Library:** 186bl, 186bc, 186t; **Plain and Simple Kitchens:** 66t; **Powerstock Photolibrary:** 169tl, 256t, 287tc; **Rail Images:** 208c, 208 cbl, 209br; **Red Consultancy:** Odeon cinemas 257br; **Redferns:** 259br; Nigel Crane 259c; **Rex Features:** 106br, 259tc, 259tr, 259bl, 280b; Charles Ommaney 114tcr; J.F.F Whitehead 243cl; Patrick Barth 101tl; Patrick Frilet 189cbl; Scott Wiseman 287bl; **Royalty Free Images:** Getty Images/Eyewire 154bl; **Science & Society Picture Library:** Science Museum 202b; **Skyscan:** 168t, 182c, 298; Quick UK Ltd 212; **Sony:** 268bc; **Robert Streeter:** 154br; **Neil Sutherland:** 82tr, 83tl, 90t, 118, 188ctr, 196tl, 196tr, 299cl, 299bl; **The Travel Library:** Stuart Black 264t; **Travelex:** 97cl; **Vauxhall:** Technik 198t, 199tl, 199tr, 199cl, 199cr, 199ctcl, 199ctcr, 199tcl, 199tcr, 200; **View Pictures:** Dennis Gilbert, Architects: ACDP Consulting, 106t; Dennis Gilbert, Chris Wilkinson Architects, 209tr; Peter Cook, Architects: Nicholas Crimshaw and partners,

208t; **Betty Walton:** 185br; **Colin Walton:** 2, 4, 7, 9, 10, 28, 42, 56, 92, 95c, 99tl, 99tcl, 102, 116, 120t, 138t, 146, 150t, 160, 170, 191ctcl, 192, 218, 252, 260br, 260l, 261tr, 261c, 261cr, 271cbl, 271cbr, 271ctcl, 278, 287br, 302, 401.

DK PICTURE LIBRARY:

Akhil Bahkshi; Patrick Baldwin; Geoff Brightling; British Museum; John Bulmer; Andrew Butler; Joe Cornish; Brian Cosgrove; Andy Crawford and Kit Houghton; Philip Dowell; Alistair Duncan; Gables; Bob Gathany; Norman Hollands; Kew Gardens; Peter James Kindersley; Vladimir Kozlik; Sam Lloyd; London Northern Bus Company Ltd; Tracy Morgan; David Murray and Jules Selmes; Musée Vivant du Cheval, France; Museum of Broadcast Communications; Museum of Natural History; NASA; National History Museum; Norfolk Rural Life Museum; Stephen Oliver; RNLI; Royal Ballet School; Guy Rycart; Science Museum; Neil Setchfield; Ross Simms and the Winchcombe Folk Police Museum; Singapore Symphony Orchestra; Smart Museum of Art; Tony Souter; Erik Svensson and Jeppe Wikstrom; Sam Tree of Keygrove Marketing Ltd; Barrie Watts; Alan Williams; Jerry Young.

Additional Photography by Colin Walton.

Colin Walton would like to thank:

A&A News, Uckfield; Abbey Music, Tunbridge Wells; Arena Mens Clothing, Tunbridge Wells; Burrells of Tunbridge Wells; Gary at Di Marco's; Jeremy's Home Store, Tunbridge Wells; Noakes of Tunbridge Wells; Ottakar's, Tunbridge Wells; Selby's of Uckfield; Sevenoaks Sound and Vision; Westfield, Royal Victoria Place, Tunbridge Wells.

All other images are Dorling Kindersley copyright. For further information see [www.dkimages.com](http://www.dkimages.com)